

NW FRONT AVE

NW 15TH AVE.

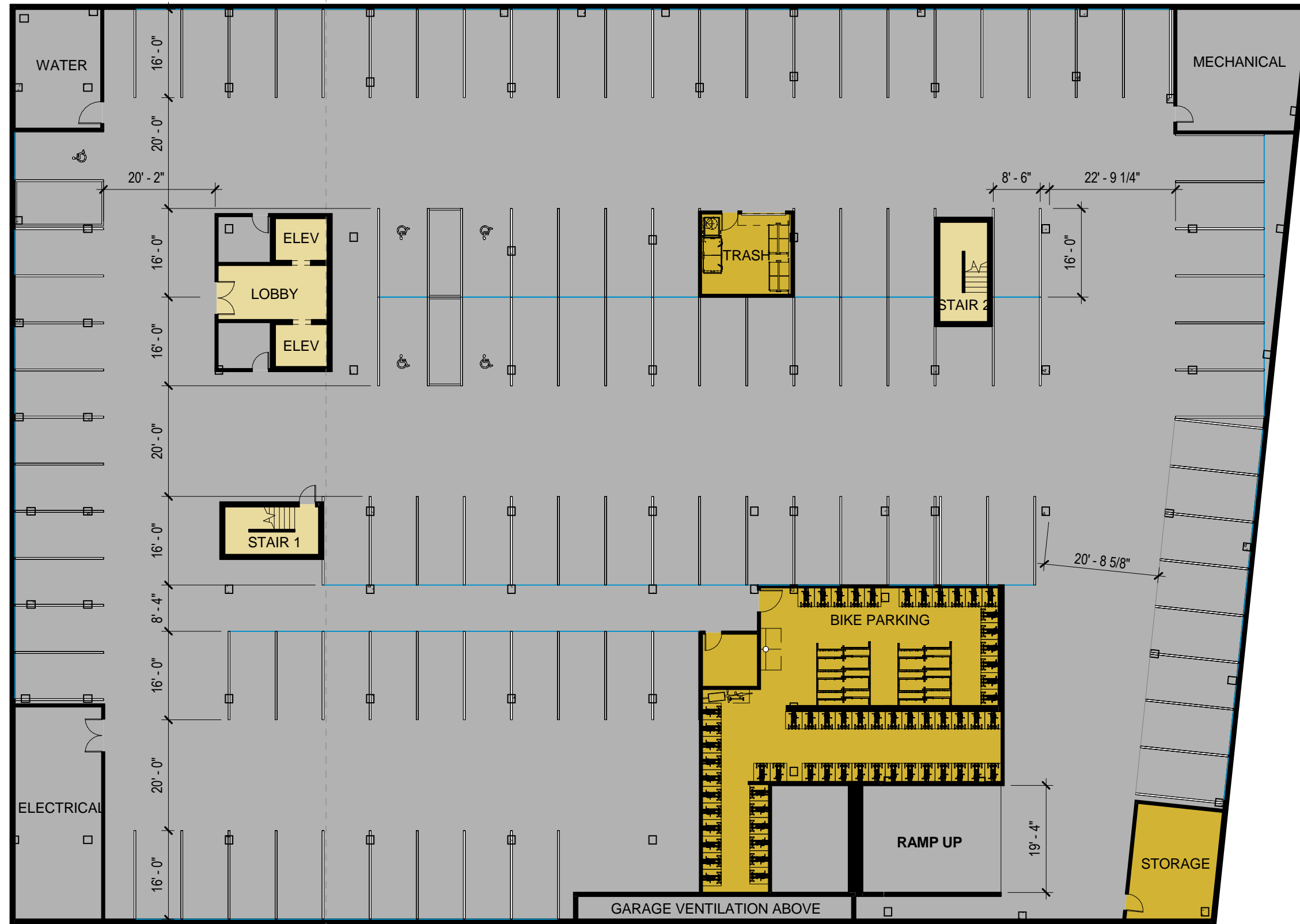



VEHICLE COUNT	
LEVEL	COUNT

PARKING LEVEL	106
LEVEL 1	32
Grand total	138



5'-0"



BASE POINT OF HEIGHT MEASUREMENT +36.00' (104.3')

IN-UNIT BICYCLE PARKING

COURTYARD - SEE LANDSCAPE

LOADING
LOADING

GARAGE VENTILATION - STEEL GRATE IN CONCRETE WALLS



0' 5' 10' 20' 30'

LEVEL 1 C37



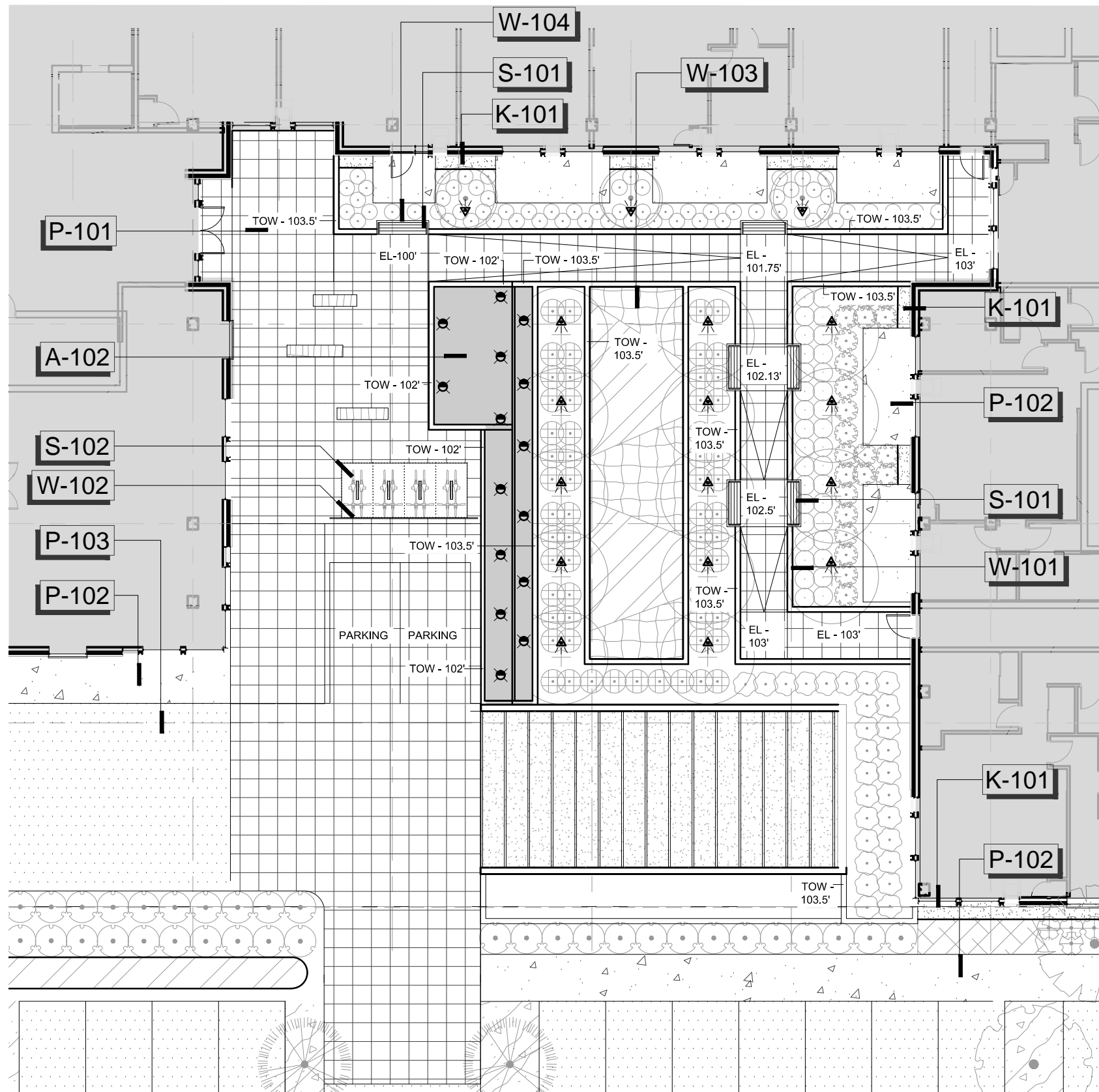

REFERENCE NOTES SCHEDULE

WATER FEATURE	
SYMBOL	DESCRIPTION
A-102	WATER FEATURE
ROCK	
SYMBOL	DESCRIPTION
K-101	STONE BALLAST, 12" WIDE WITH 3-5" ROCK
CONCRETE	
SYMBOL	DESCRIPTION
P-101	PERMEABLE CONCRETE PAVERS
P-102	CONCRETE PAVING
P-103	ASPHALT SURFACING
SITE FURNISHINGS	
SYMBOL	DESCRIPTION
S-101	BENCH SEATING
S-102	BIKE PARKING
WALL	
SYMBOL	DESCRIPTION
W-101	CONCRETE WALLS
W-102	GLASS WALL PANEL
W-103	STORM WATER PLANTER
W-104	STEEL PLANTER WALL

LIGHTING SCHEDULE

SYMBOL	MANUFACTURER/MODEL/DESCRIPTION	QTY	DETAIL
▼	TREE UPLIGHT	17	
⊗	WATER FEATURE LIGHTING	14	





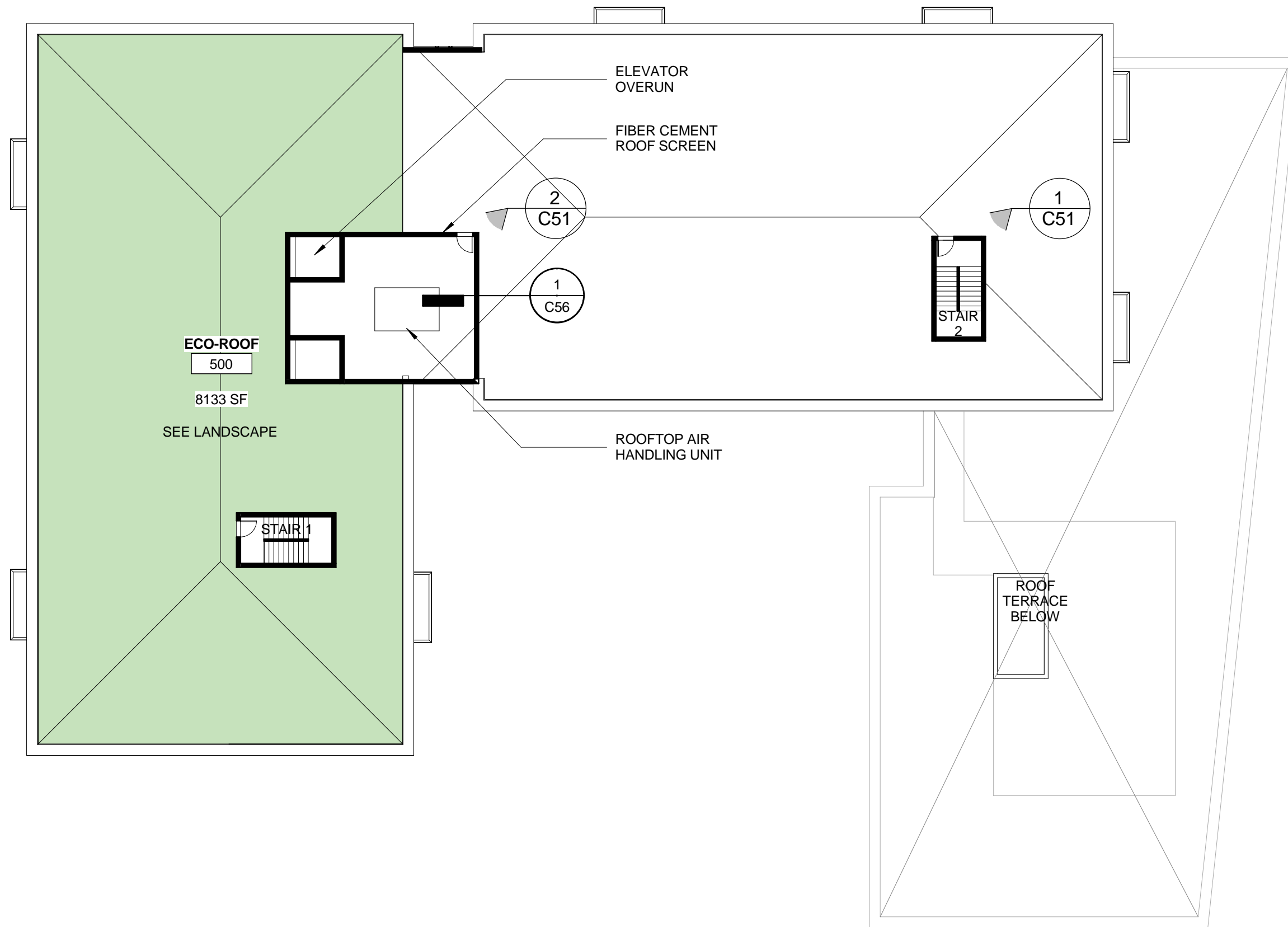





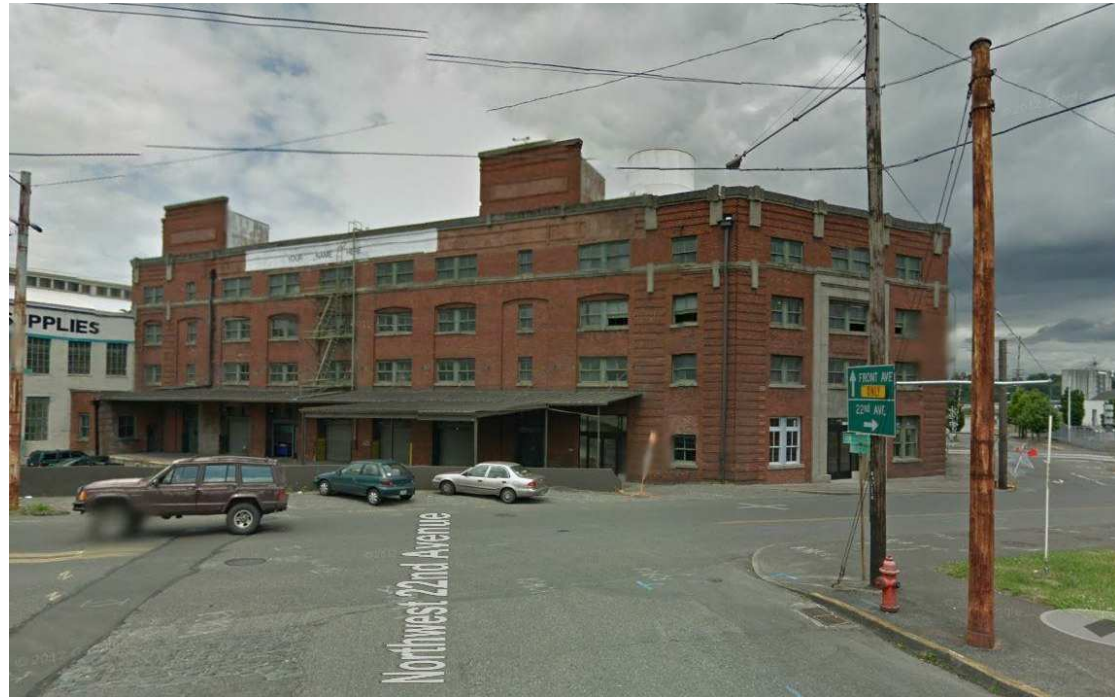

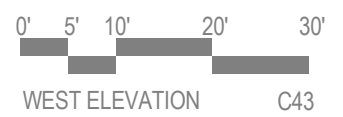
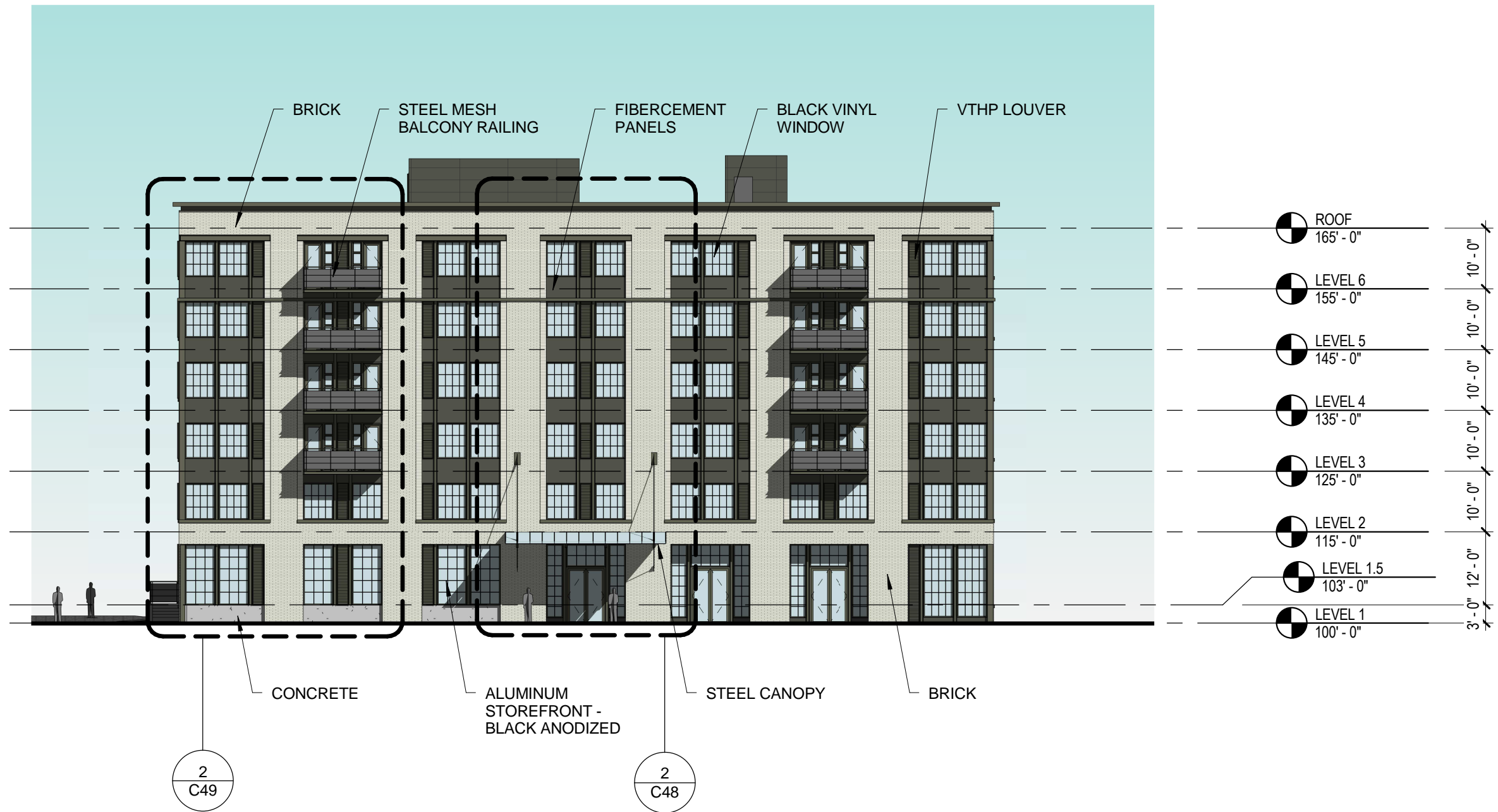









ENLARGED ELEVATION ②

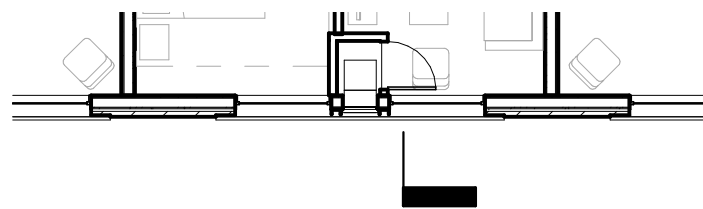

WALL PLAN ③

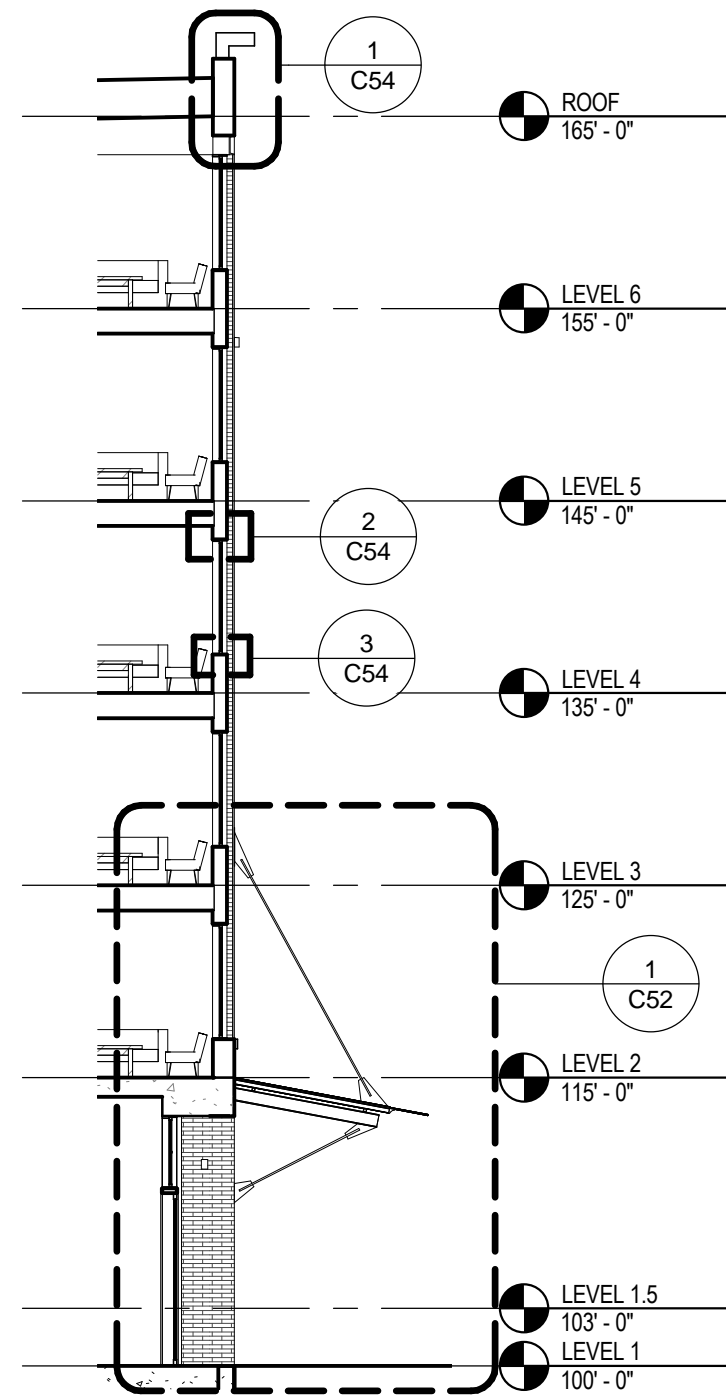

WALL SECTION ①



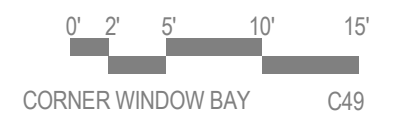
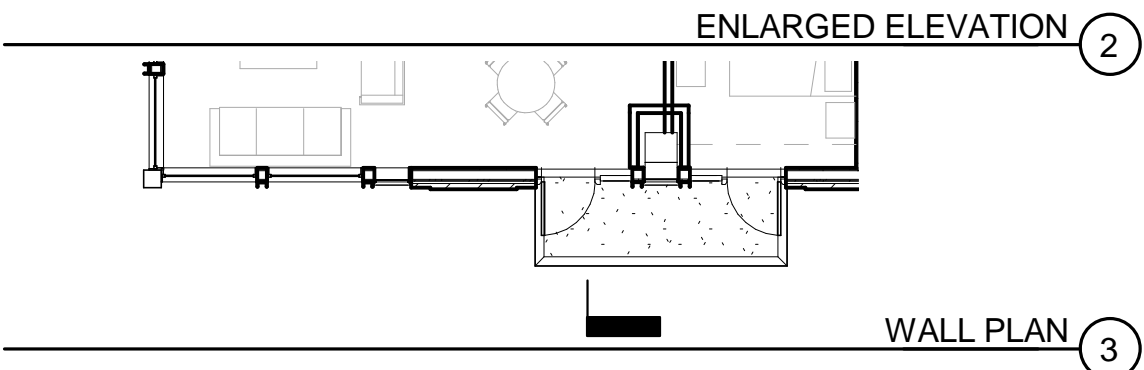
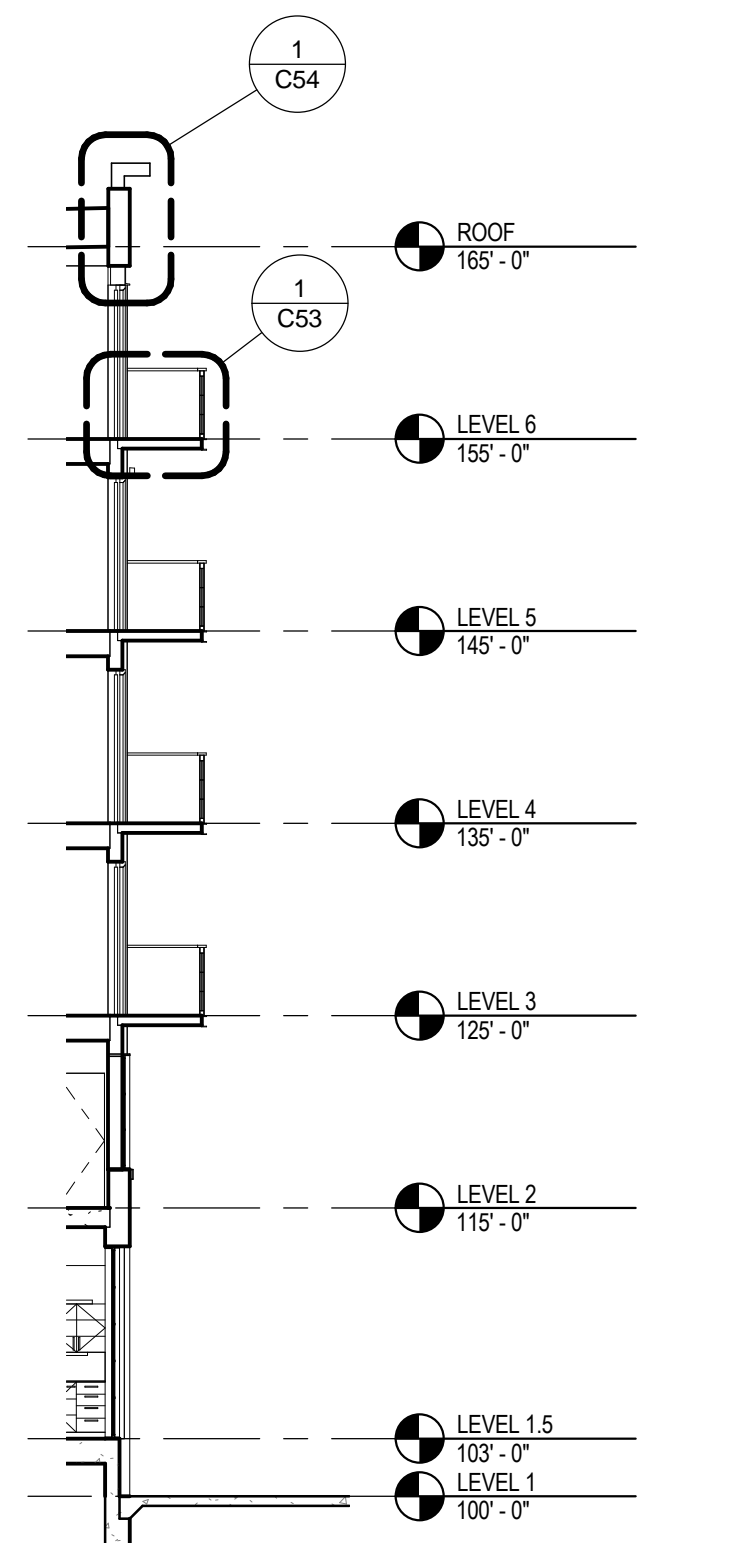
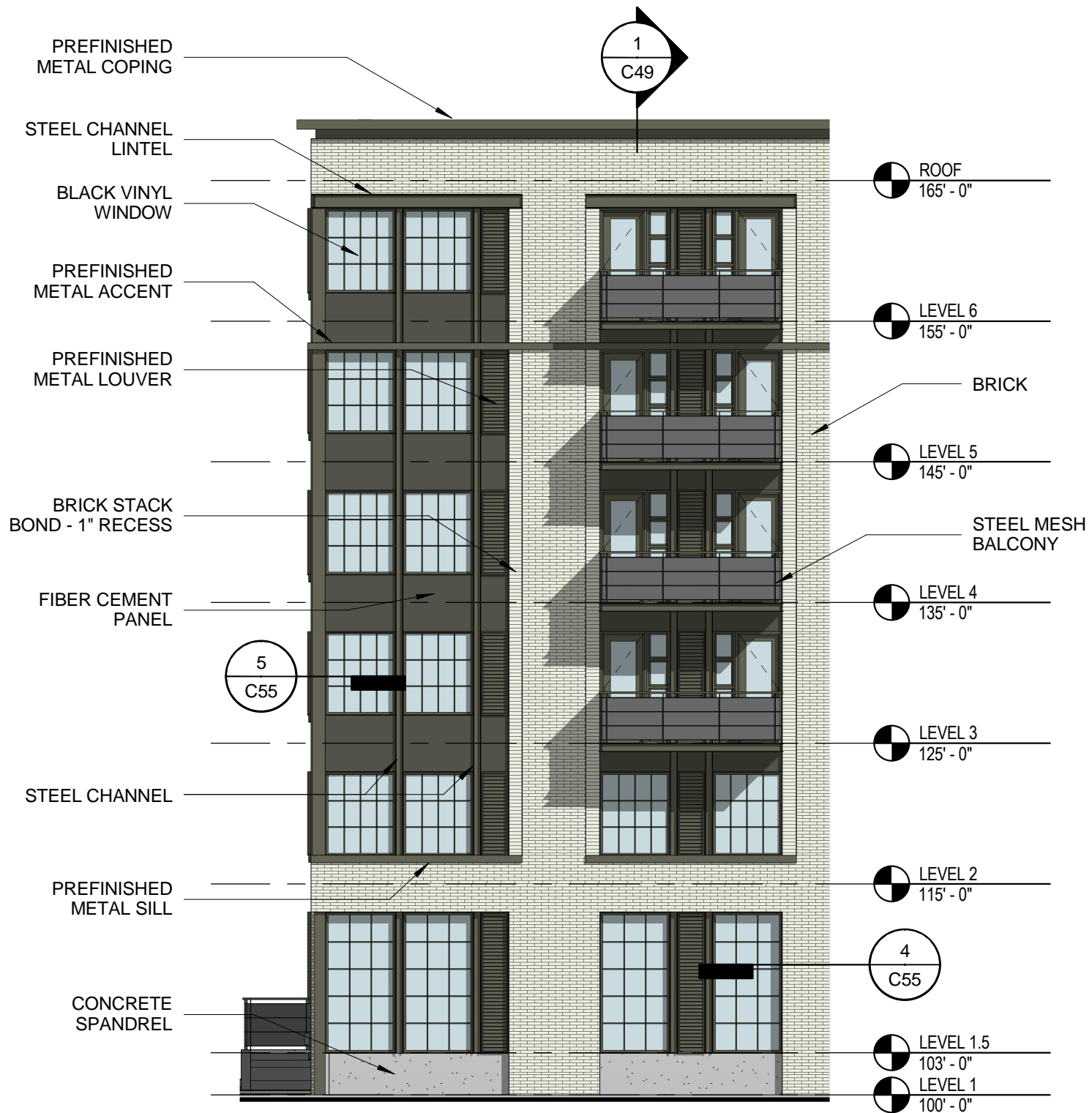

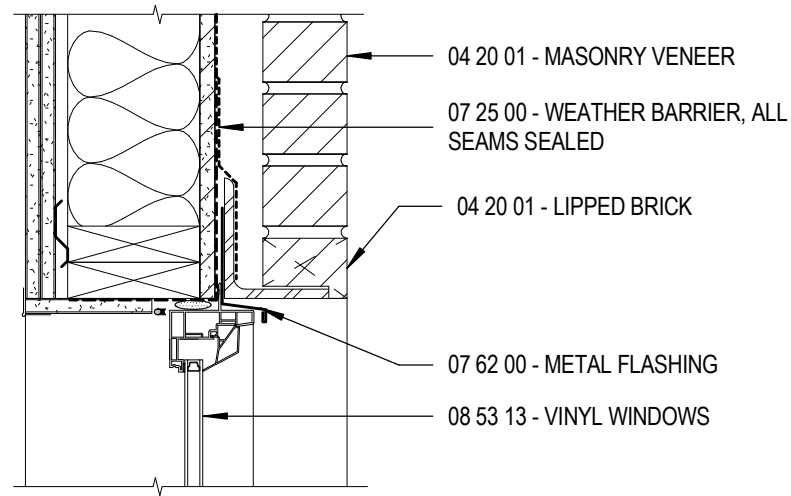

WINDOW HEAD AT BRICK ④

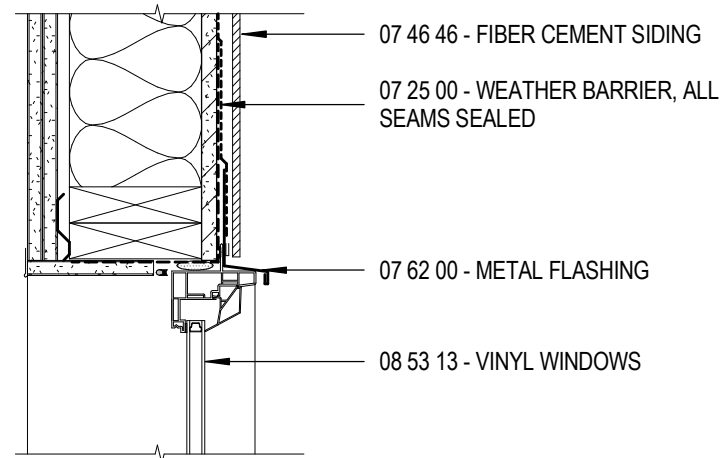

WINDOW HEAD ②

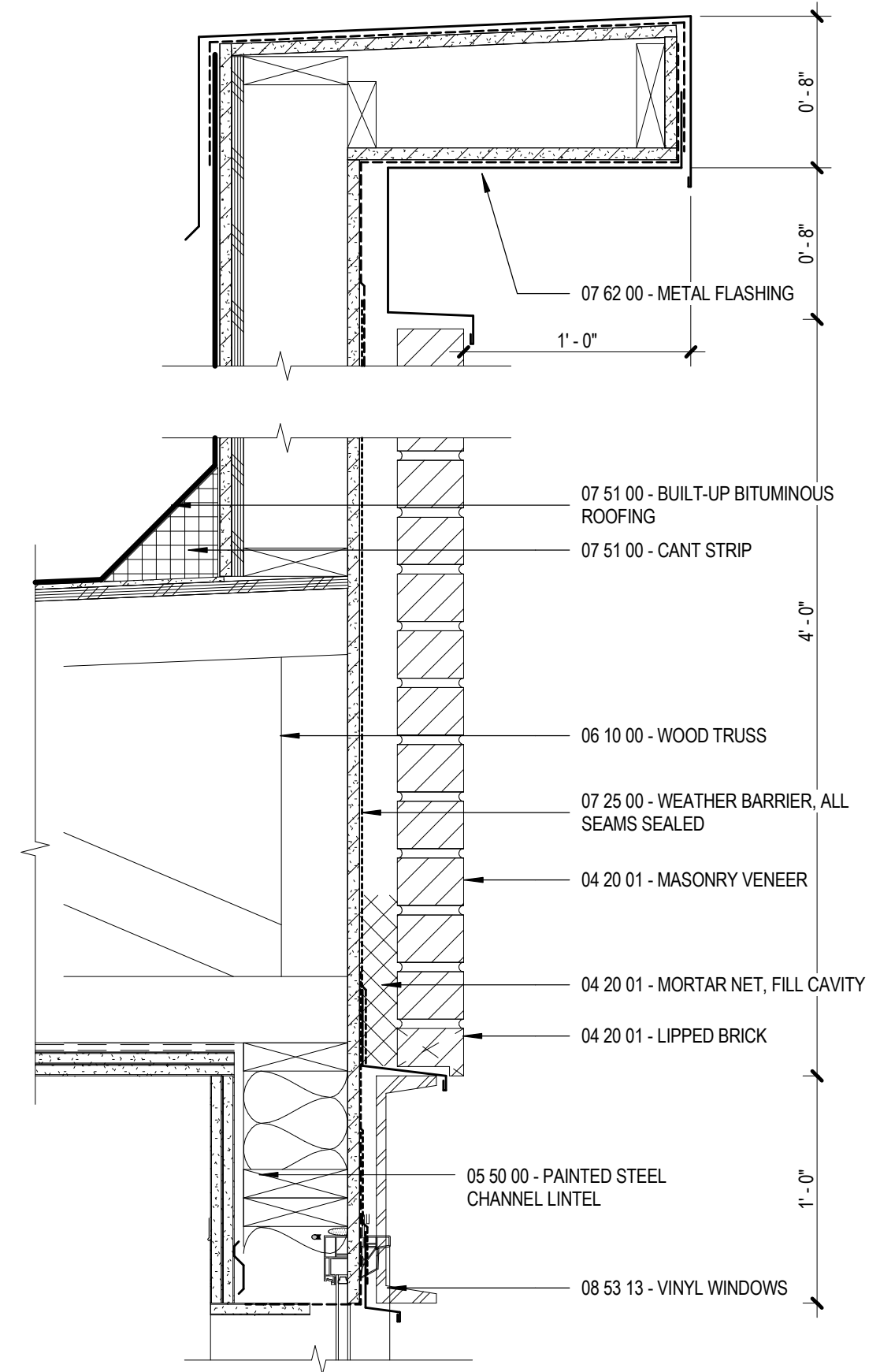

PARAPET ①

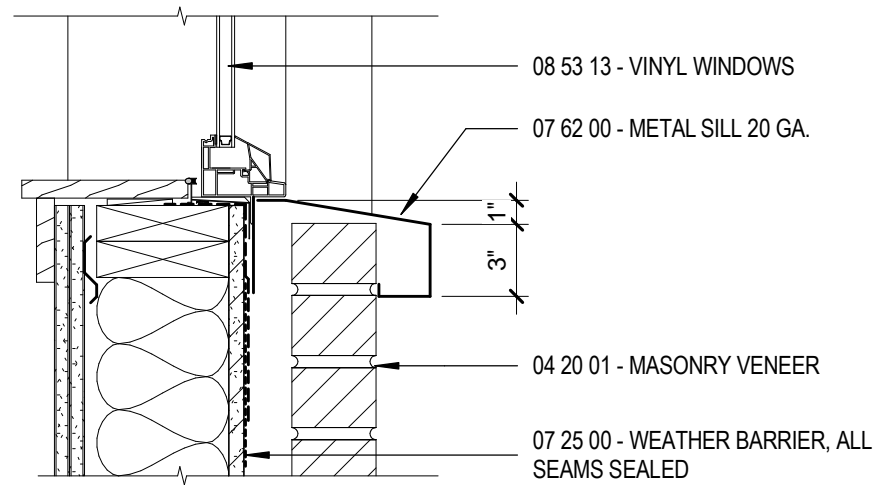

WINDOW SILL AT BRICK ⑤

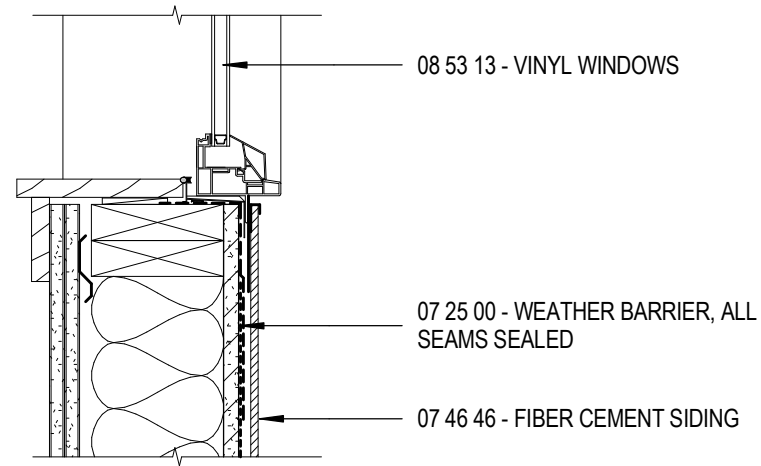

WINDOW SILL ③

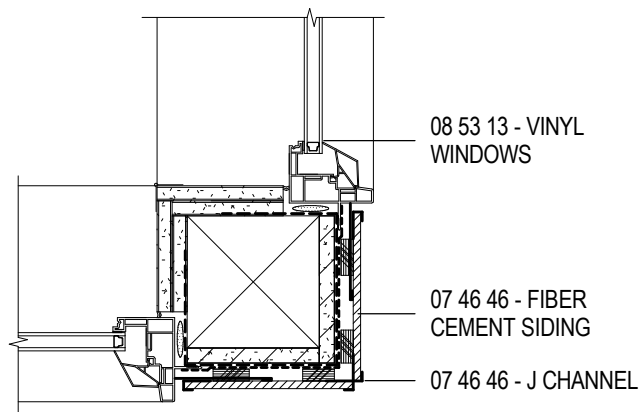

- 08 53 13 - VINYL WINDOWS
- 07 46 46 - FIBER CEMENT SIDING
- 07 46 46 - J CHANNEL

CORNER WINDOW JAMB 5

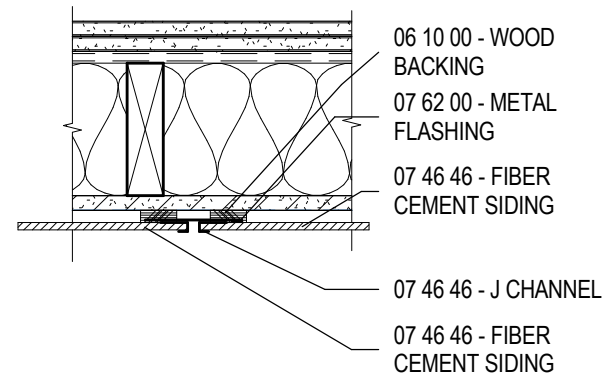

- 06 10 00 - WOOD BACKING
- 07 62 00 - METAL FLASHING
- 07 46 46 - FIBER CEMENT SIDING
- 07 46 46 - J CHANNEL
- 07 46 46 - FIBER CEMENT SIDING

FCP JOINT VERTICAL 3

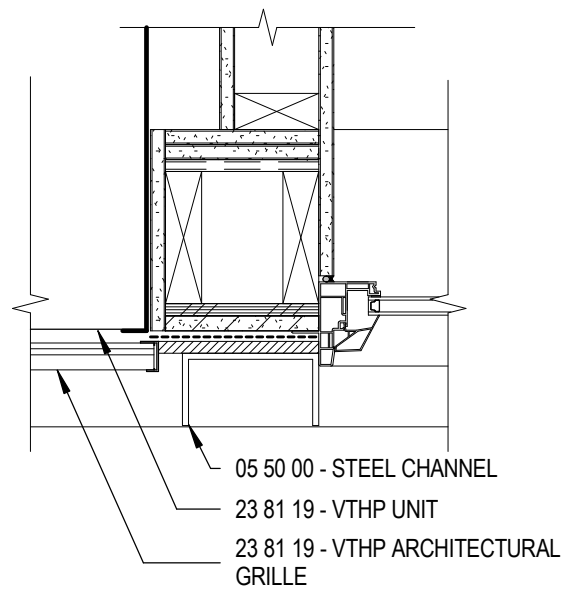

- 05 50 00 - STEEL CHANNEL
- 23 81 19 - VTHP UNIT
- 23 81 19 - VTHP ARCHITECTURAL GRILLE

WINDOW & VTHP @ WINDOW BAY 1

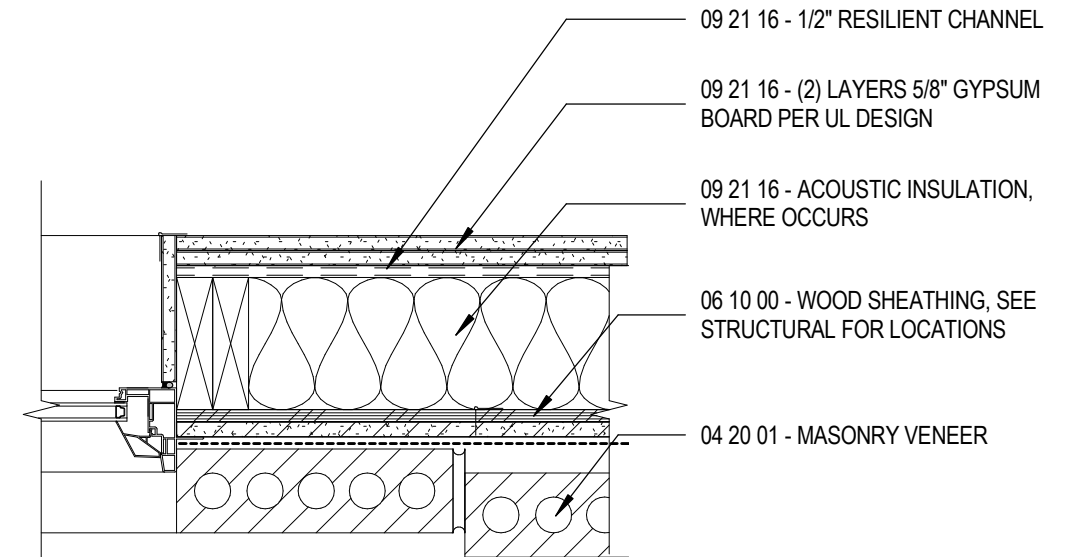

- 09 21 16 - 1/2" RESILIENT CHANNEL
- 09 21 16 - (2) LAYERS 5/8" GYPSUM BOARD PER UL DESIGN
- 09 21 16 - ACOUSTIC INSULATION, WHERE OCCURS
- 06 10 00 - WOOD SHEATHING, SEE STRUCTURAL FOR LOCATIONS
- 04 20 01 - MASONRY VENEER

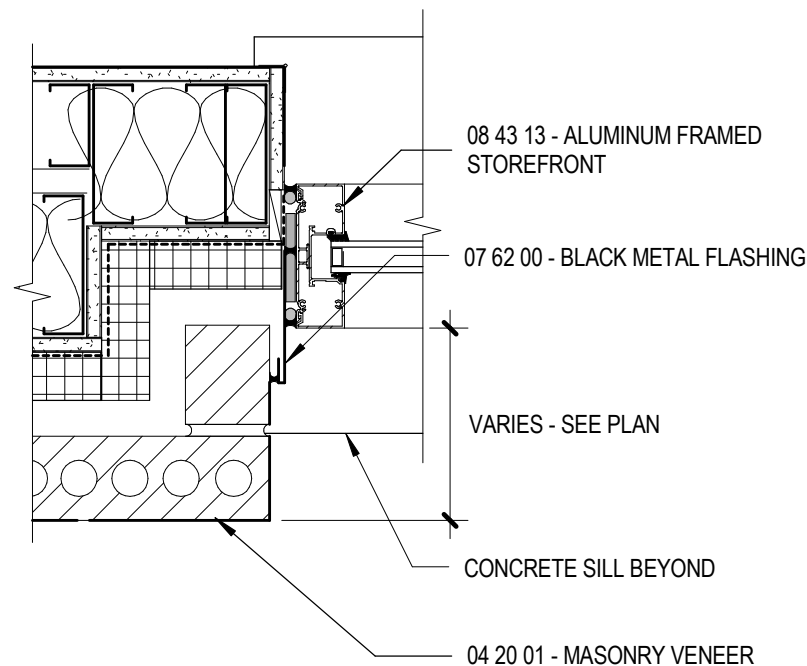

- 08 43 13 - ALUMINUM FRAMED STOREFRONT
- 07 62 00 - BLACK METAL FLASHING
- VARIES - SEE PLAN
- CONCRETE SILL BEYOND
- 04 20 01 - MASONRY VENEER

STOREFRONT JAMB @ GROUND LEVEL 4

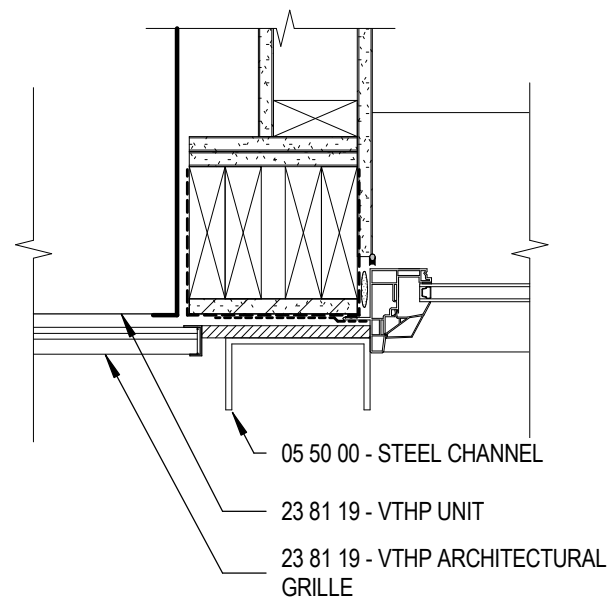

- 05 50 00 - STEEL CHANNEL
- 23 81 19 - VTHP UNIT
- 23 81 19 - VTHP ARCHITECTURAL GRILLE

WINDOW & VTHP JAMB @ FLUSH BRICK 2

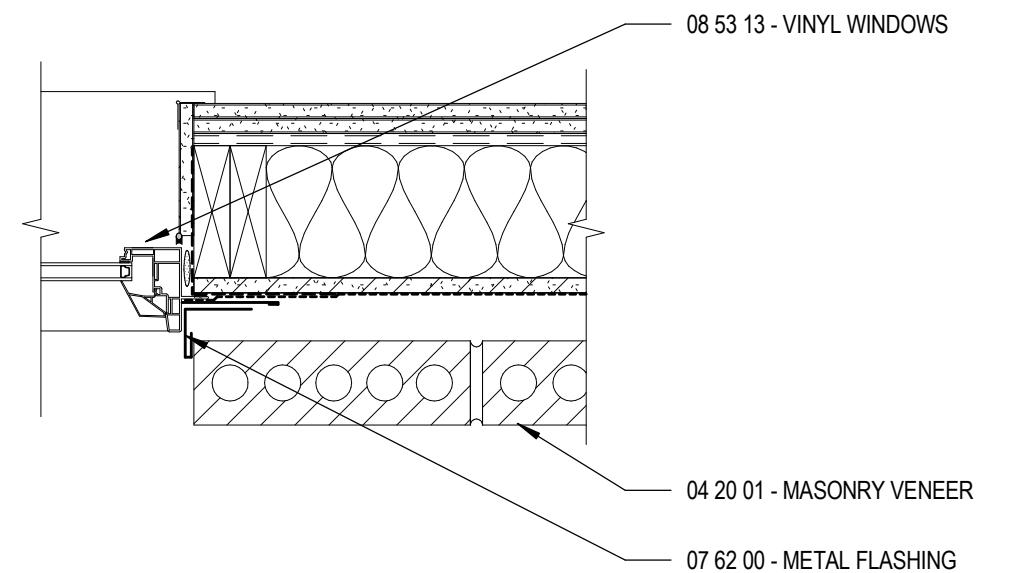

- 08 53 13 - VINYL WINDOWS
- 04 20 01 - MASONRY VENEER
- 07 62 00 - METAL FLASHING





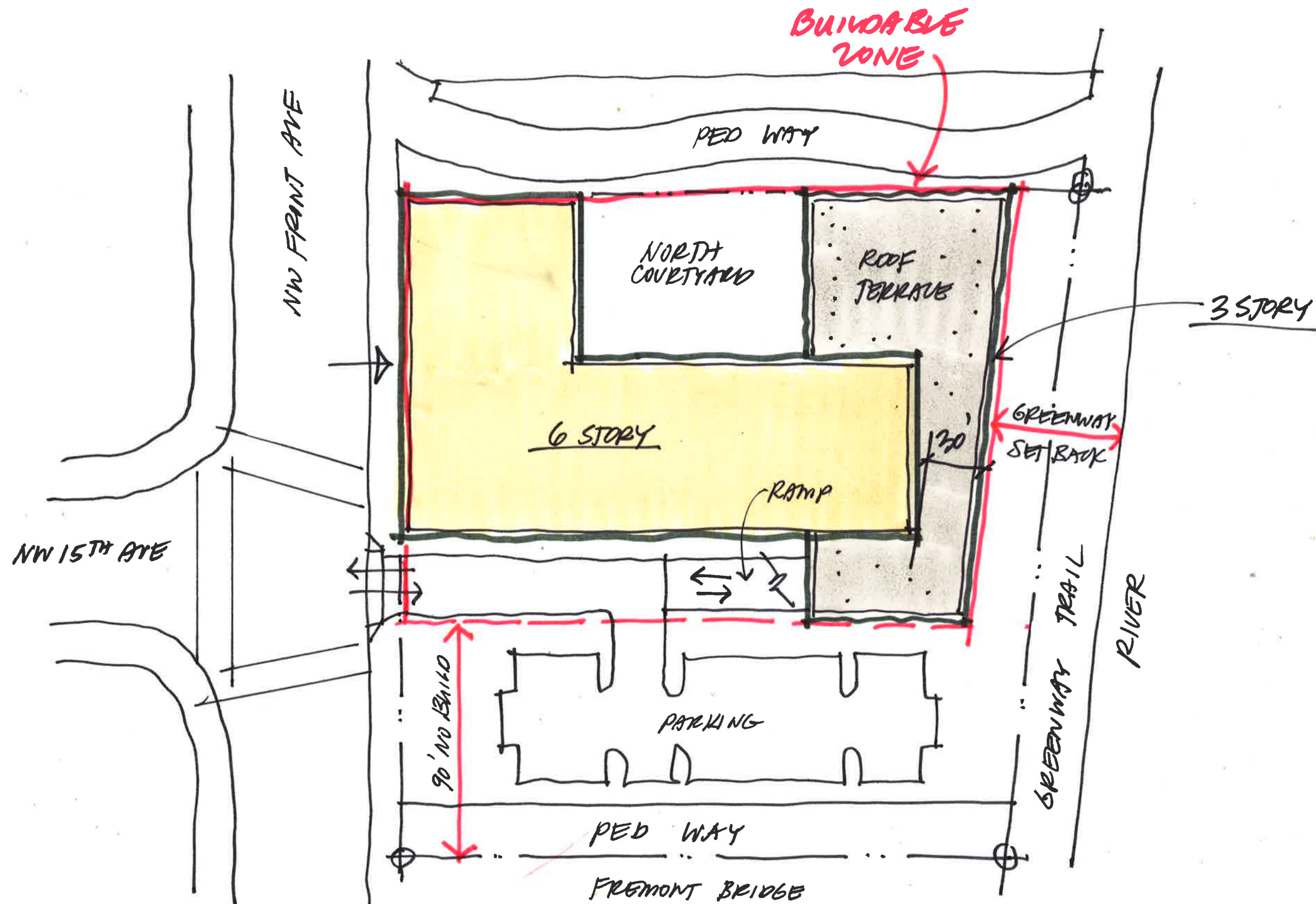

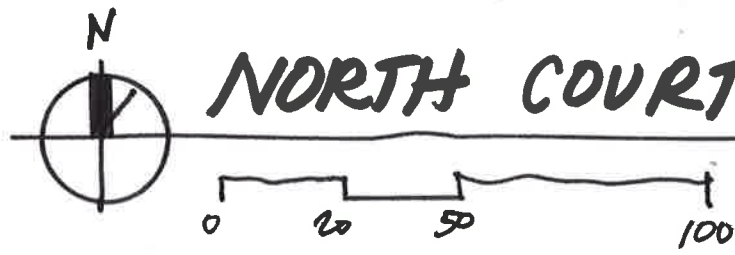
NORTH COURTYARD 'C' SHAPE

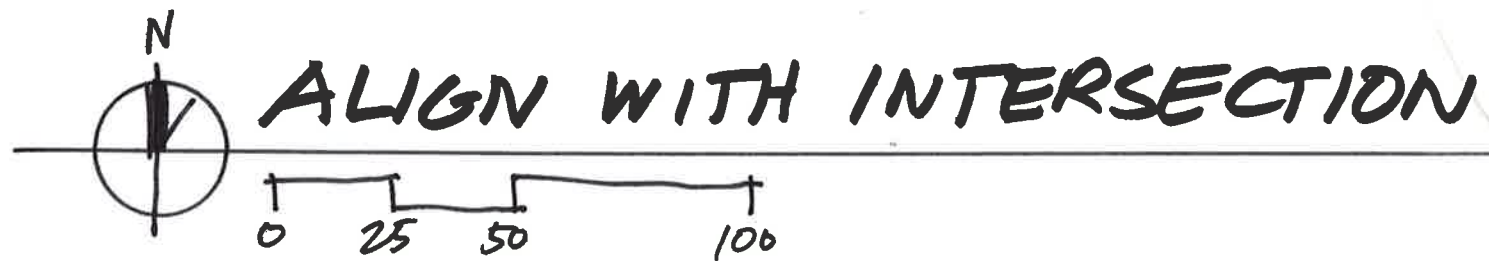
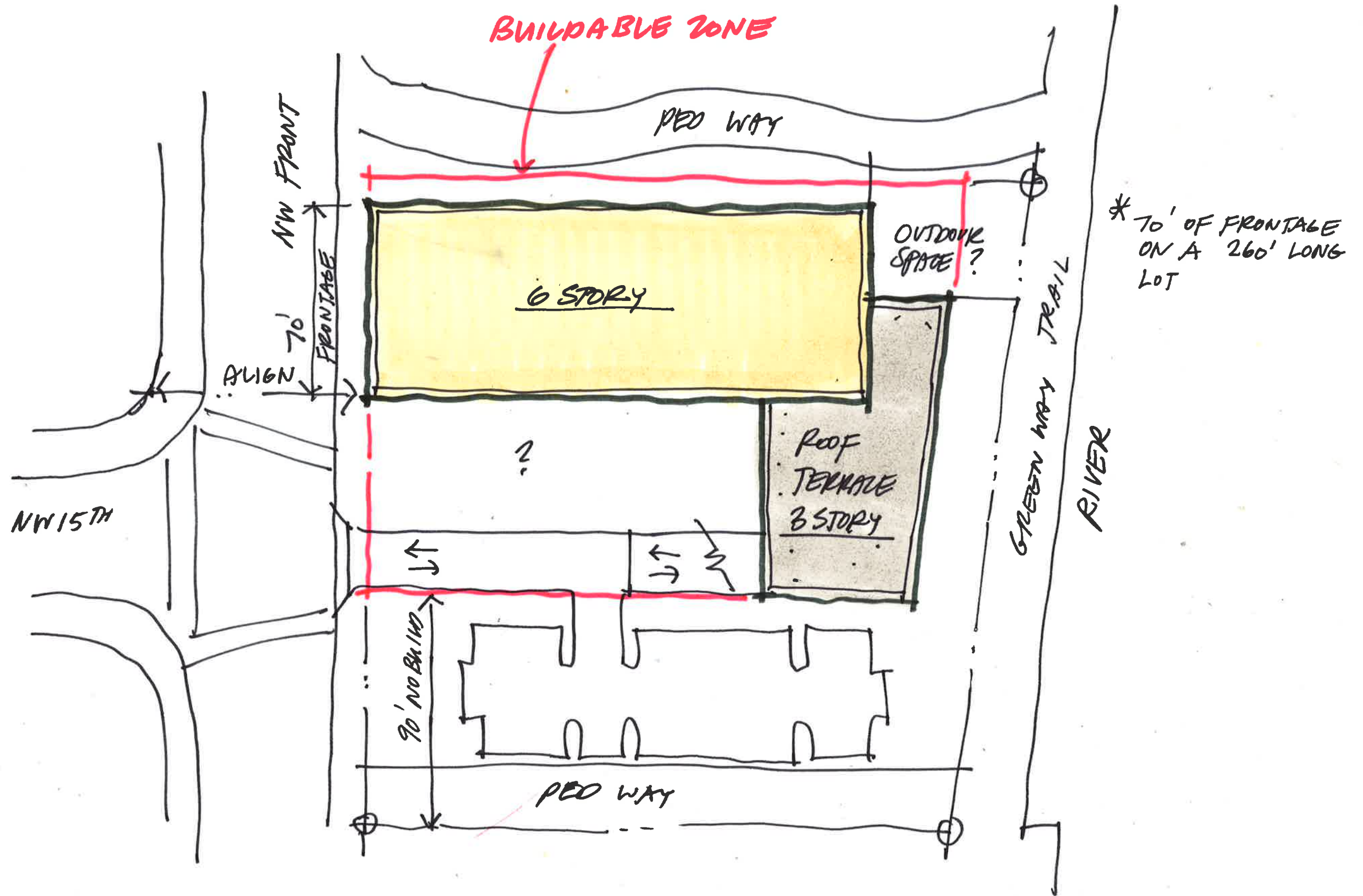
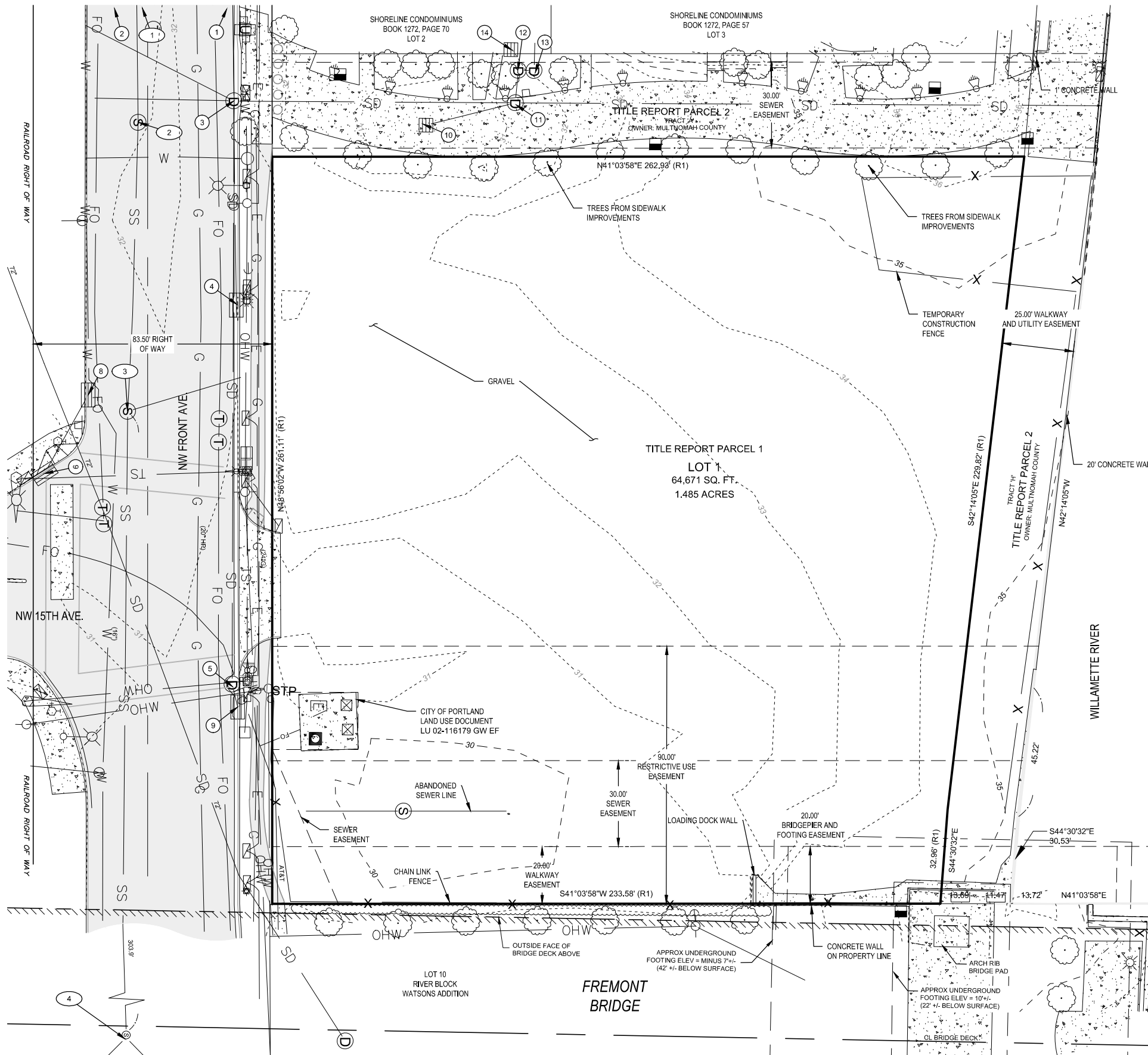

TABLE OF CONTENTS

VIEW FROM NORTHWEST	C1	NORTH ELEVATION	C44
AERIAL VIEW FROM EAST	C2	EAST ELEVATION	C45
INDEX	C3	SOUTH ELEVATION	C46
VIEW FROM SOUTHWEST	C4	COURTYARD ELEVATIONS	C47
LOCATION PLAN	C5	WEST CENTER WINDOW BAY	C48
CONTEXT	C6	CORNER WINDOW BAY	C49
WILLAMETTE GREENWAY	C7	NORTH BUILDING SPLIT	C50
SITE CONSTRAINTS	C8	OVERRUN SCREEN	C51
SITE IMAGES	C9	EXTERIOR DETAILS - CANOPY	C52
WATERFRONT WAREHOUSES	C10	EXTERIOR DETAILS - BALCONY	C53
SITE EXISTING CONDITIONS	C11	EXTERIOR DETAILS	C54
SITE UTILITY PLAN	C12	EXTERIOR DETAILS	C55
SITE GRADING PLAN	C13	EXTERIOR DETAILS	C56
LANDSCAPE - SITE PLAN	C14		
LANDSCAPE - GROUND LEVEL CONSTRUCTION PLAN	C15		
LANDSCAPE - COURTYARD CONSTRUCTION PLAN	C16		
LANDSCAPE - ROOFDECK CONSTRUCTION PLAN	C17		
LANDSCAPE - GROUND LEVEL PLANTING PLAN	C18		
LANDSCAPE - GROUND LEVEL PLANT SCHEDULE	C19		
LANDSCAPE - ROOFDECK PLANTING PLAN	C20		
LANDSCAPE - ECOROOF PLANTING PLAN	C21		
LANDSCAPE - ECOROOF IRRIGATION	C22		
LANDSCAPE - ECOROOF NOTES	C23		
LANDSCAPE - SHRUB PALETTE	C24		
LANDSCAPE - TREE, GRASS & SEDUM PALETTE	C25		
LANDSCAPE - SITE FURNISHINGS & MATERIALS	C26		
LANDSCAPE - ROOFDECK FURNISHINGS & MATERIALS	C27		
LANDSCAPE - 3D VIEWS	C28		
LANDSCAPE - 3D VIEWS	C29		
PROPOSED TRAIL CONNECTION	C30		
LIGHTING PLAN	C31		
MATERIAL PALETTE	C32		
FAR	C33		
NORTH PEARL SUBAREA WATERFRONT DEVELOPMENT STANDARDS	C34		
12' BUILDING SETBACK VIOLATIONS AT RIVERSCAPE	C35		
PARKING	C36		
LEVEL 1	C37		
LEVEL 2-3	C38		
LEVEL 4	C39		
LEVEL 5-6	C40		
ROOF	C41		
BIKE PARKING	C42		
WEST ELEVATION	C43		



LEGEND:

- EXISTING BOUNDARY LINE
- EXISTING CENTERLINE
- EXISTING RIGHT-OF-WAY LINE
- EASEMENT LINE
- FENCE LINE, TYPE AS NOTED
- STORM DRAINAGE LINE
- SANITARY SEWER LINE
- UNDERGROUND WATER LINE
- UNDERGROUND ELECTRICAL LINE
- UNDERGROUND FIBER OPTIC LINE
- UNDERGROUND NATURAL GAS LINE
- OVERHEAD WIRE
- EXISTING ASPHALT SURFACE
- EXISTING CONCRETE SURFACE
- SANITARY SEWER MANHOLE
- STORM DRAIN MANHOLE
- CATCH BASIN
- CATCH BASIN - TRAPPED TYPE
- FIRE HYDRANT
- WATER VALVE
- IRRIGATION CONTROL BOX
- GROUND LIGHT
- ACORN/GLOBE LIGHT
- STREET LIGHT (COBRA ARM)
- STREET LIGHT JUNCTION BOX
- ELECTRIC METER
- ELECTRIC JUNCTION BOX
- ELECTRICAL CABINET
- UTILITY POLE
- GUY WIRE
- TELEPHONE RISER
- TELEPHONE MANHOLE
- TRAFFIC SIGNAL POLE
- TRAFFIC SIGNAL POLE AND STREET LIGHT
- PEDESTRIAN SIGNAL POLE
- SIGNAL JUNCTION BOX
- STAND PIPE
- UNKNOWN RISER
- UNKNOWN UTILITY VAULT
- BOLLARD
- GATE POST
- SIGN POST
- RAILROAD SIGN
- DECIDUOUS TREE

BASIS OF BEARINGS:

BASIS OF BEARING WAS DERIVED FROM THE FOUND AND HELD MONUMENTS MARKING THE NORTHERLY BOUNDARY LINE OF LOT 1 OF THE PLAT OF RIVERNORTH, MULTNOMAH COUNTY SURVEY RECORDS, NORTH 41°03'58" EAST, AS SHOWN HEREON.

DATUM:

ELEVATION DATUM: CITY OF PORTLAND
 BENCHMARK: # 3544
 LOCATION: - BRASS DISK SET IN TOP OF CURB AT THE NE CORNER OF NW FRONT AVE. AND NW 16TH AVE.
 ELEVATION: 30.82 FEET

UTILITY STATEMENT:

THE UNDERGROUND UTILITIES SHOWN HAVE BEEN LOCATED FROM FIELD SURVEY INFORMATION AND EXISTING DRAWINGS. THE SURVEYOR MAKES NO GUARANTEES THAT THE UNDERGROUND UTILITIES SHOWN COMPRISE ALL SUCH UTILITIES IN THE AREA, EITHER IN SERVICE OR ABANDONED. THE SURVEYOR FURTHER DOES NOT WARRANT THAT THE UNDERGROUND UTILITIES SHOWN ARE IN THE EXACT LOCATION INDICATED, ALTHOUGH HE DOES CERTIFY THAT THEY ARE LOCATED AS ACCURATELY AS POSSIBLE FROM INFORMATION AVAILABLE.

LEGAL DESCRIPTION:

LOT 1 OF THE PLAT OF "RIVERNORTH" LOCATED IN SECTION 28, TOWNSHIP 1 NORTH, RANGE 1 EAST, WILLAMETTE MERIDIAN, CITY OF PORTLAND, MULTNOMAH COUNTY, OREGON

NOTES:

1. THE LEGAL DESCRIPTION AND EXCEPTIONS SHOWN HEREON ARE BASED ON THE PRELIMINARY TITLE REPORT ISSUED BY FIDELITY NATIONAL TITLE INSURANCE CO. ORDER NO. 20130087924-FTPOR01, EFFECTIVE DATE DECEMBER 6, 2013.
2. MANHOLES SHOWN HEREON ARE TO CENTER OF MANHOLE LID, NOT CENTER OF STRUCTURE.
3. GROSS LAND AREA 64,671 SQ. FT. OR 1.485 ACRES.
4. UNDERGROUND UTILITIES SHOWN HEREON ARE FROM READILY IDENTIFIABLE SURFACE INDICATORS AND UTILITY SERVICE PROVIDER DATA MARKS.

STORM DRAINAGE TABLE:

1	STORM DRAINAGE MANHOLE RIM = 31.04' 12" CONC(S) 18.19' 18" CONC(W) = 18.04' 18" CONC(E) = 18.02'	10	CATCH BASIN TRAPPED INLET (N) RIM = 30.13' SUMP = 26.38'
2	STORM DRAINAGE MANHOLE RIM = 31.14' 12" PVC(N) = 18.80' 12" PVC(S) = 23.86'	11	STORM DRAINAGE MANHOLE RIM = 31.30' 6" PVC(S) = 26.67' 12" PVC(W) = 21.75' CHANNEL (S) = 9.77' CHANNEL (N) = 9.72'
3	STORM DRAINAGE MANHOLE RIM = 31.48' 8" CONC(E) = 25.00' 8" CONC(S/W) = 21.28' 12" CONC(E) = 18.81' 18" CONC(W) = 16.97' 12" CONC(E) = 14.67' 12" CONC(W) = 13.12' 24" CONC(S) = 11.41' 24" CONC(N) = 11.41'	12	STORM DRAINAGE MANHOLE - FILTERRA RIM = 31.92' 12" PVC(E) = 21.64'
4	CATCH BASIN RIM = 31.03' 8" CONC(W) = 26.73'	13	STORM DRAINAGE MANHOLE - FILTERRA RIM = 32.10' 12" PVC(W) = 23.50'
5	STORM DRAINAGE MANHOLE RIM = 30.41' 10" CONC(E) = 26.95' 12" CONC(W) = 22.25'	14	CATCH BASIN TRAPPED INLET (N) RIM = 31.98' SUMP = 27.61'

SANITARY SEWER TABLE:

1	SANITARY SEWER MANHOLE RIM = 31.16' 12" STEEL(N) = 22.53' 15" CONC(W) = 21.52' 15" CONC(E) = 21.47'
2	SANITARY SEWER MANHOLE RIM = 31.97' 15" CONC(E) = 24.72' 15" CONC(W) = 11.98'
3	SANITARY SEWER MANHOLE RIM = 31.55' 12" PVC(N/W) = 20.73' 15" CONC(W) = 20.24' 15" CONC(E) = 20.19'
4	SANITARY SEWER MANHOLE RIM = 29.73' 8" PVC(N/E) = 19.72' 15" CONC(W) = 19.01' 15" CONC(SE) = 18.88'

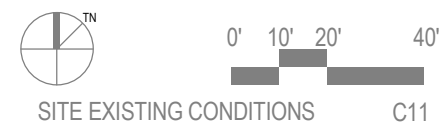

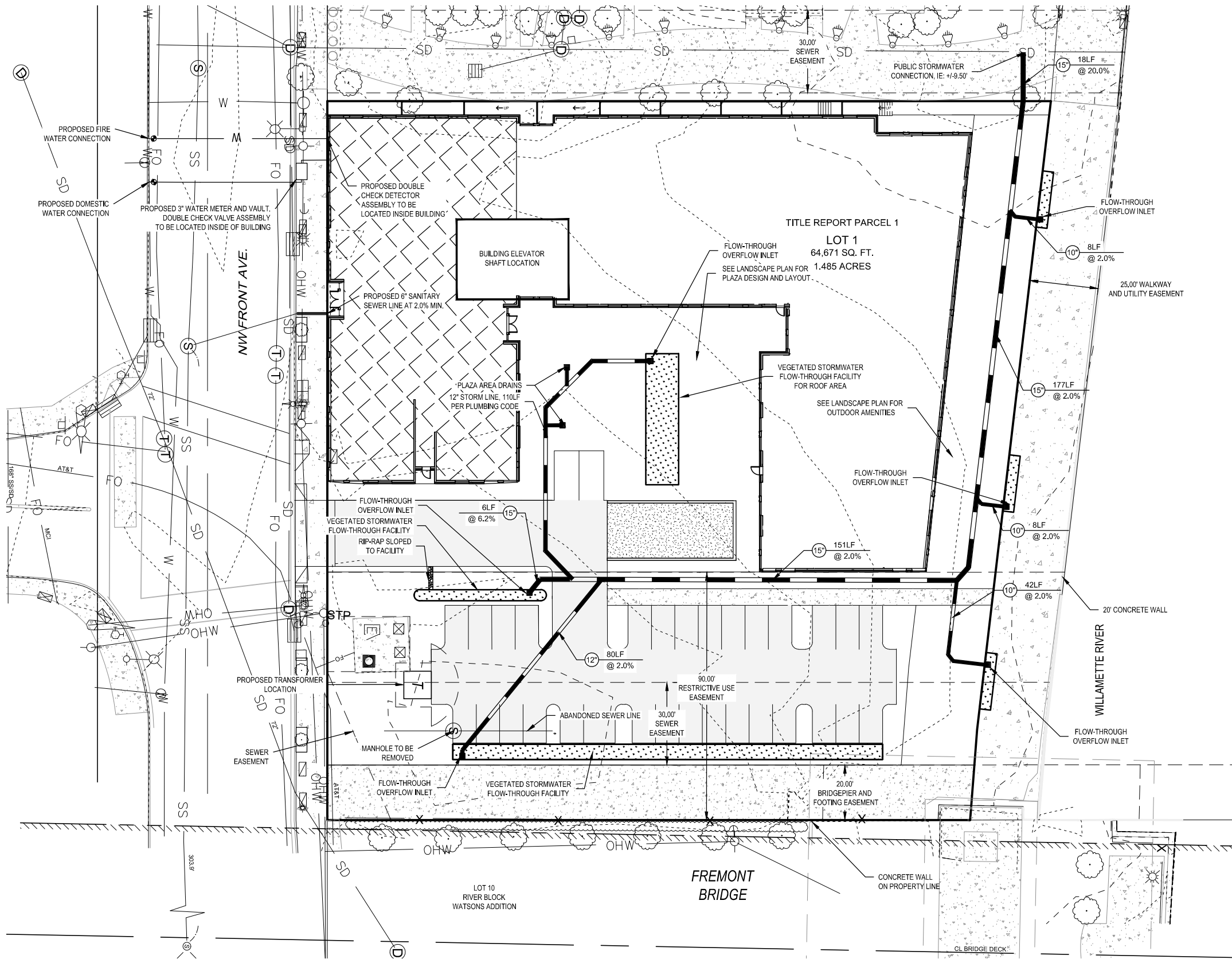

LEGEND:

- EXISTING BOUNDARY LINE
- EXISTING CENTERLINE
- EXISTING RIGHT-OF-WAY LINE
- EASEMENT LINE
- PROPOSED CONCRETE LINE
- PROPOSED CURB LINE
- PROPOSED STORM LINE
- PROPOSED WATER LINE
- PROPOSED SEWER LINE
- EXISTING CONCRETE SURFACE
- PROPOSED CONCRETE SURFACE
- PROPOSED DRIVE-ABLE SURFACE
- PROPOSED STORMWATER PLANTER
- PROPOSED GREEN ROOF
- PROPOSED AREA DRAIN



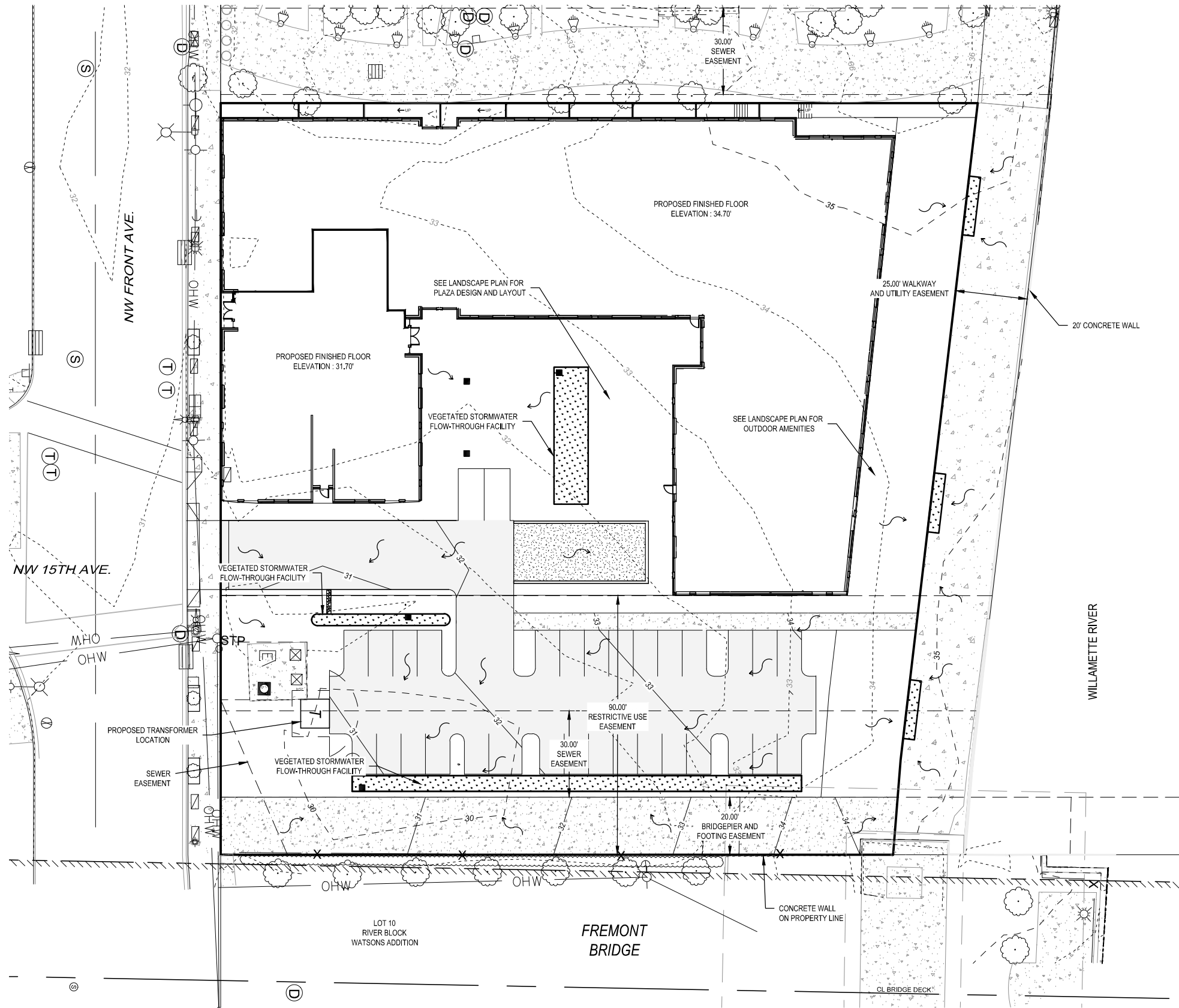

LEGEND:

- EXISTING BOUNDARY LINE
- EXISTING CENTERLINE
- EXISTING RIGHT-OF-WAY LINE
- EASEMENT LINE
- PROPOSED CONCRETE LINE
- PROPOSED CURB LINE
- PROPOSED STORM LINE
- PROPOSED WATER LINE
- PROPOSED SEWER LINE
- 30 - PROPOSED MAJOR CONTOUR
- 31 - PROPOSED MINOR CONTOUR
- 30 - EXISTING MAJOR CONTOUR
- 31 - EXISTING MINOR CONTOUR
- EXISTING CONCRETE SURFACE
- PROPOSED CONCRETE SURFACE
- PROPOSED DRIVE-ABLE SURFACE
- PROPOSED STORMWATER PLANTER
- PROPOSED DRAINAGE AREA
- PROPOSED AREA DRAIN

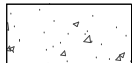

REFERENCE NOTES SCHEDULE

CONCRETE	
SYMBOL	DESCRIPTION
	PERMEABLE CONCRETE PAVERS
	CONCRETE PAVING

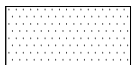
	ASPHALT SURFACING
---	-------------------

ROCK	
SYMBOL	DESCRIPTION
	STONE BALLAST, 12" WIDE WITH 3-5" ROCK

LIGHTING_SCHEDULE

SYMBOL	MANUFACTURER/MODEL/DESCRIPTION	QTY
	LIGHT POST	9

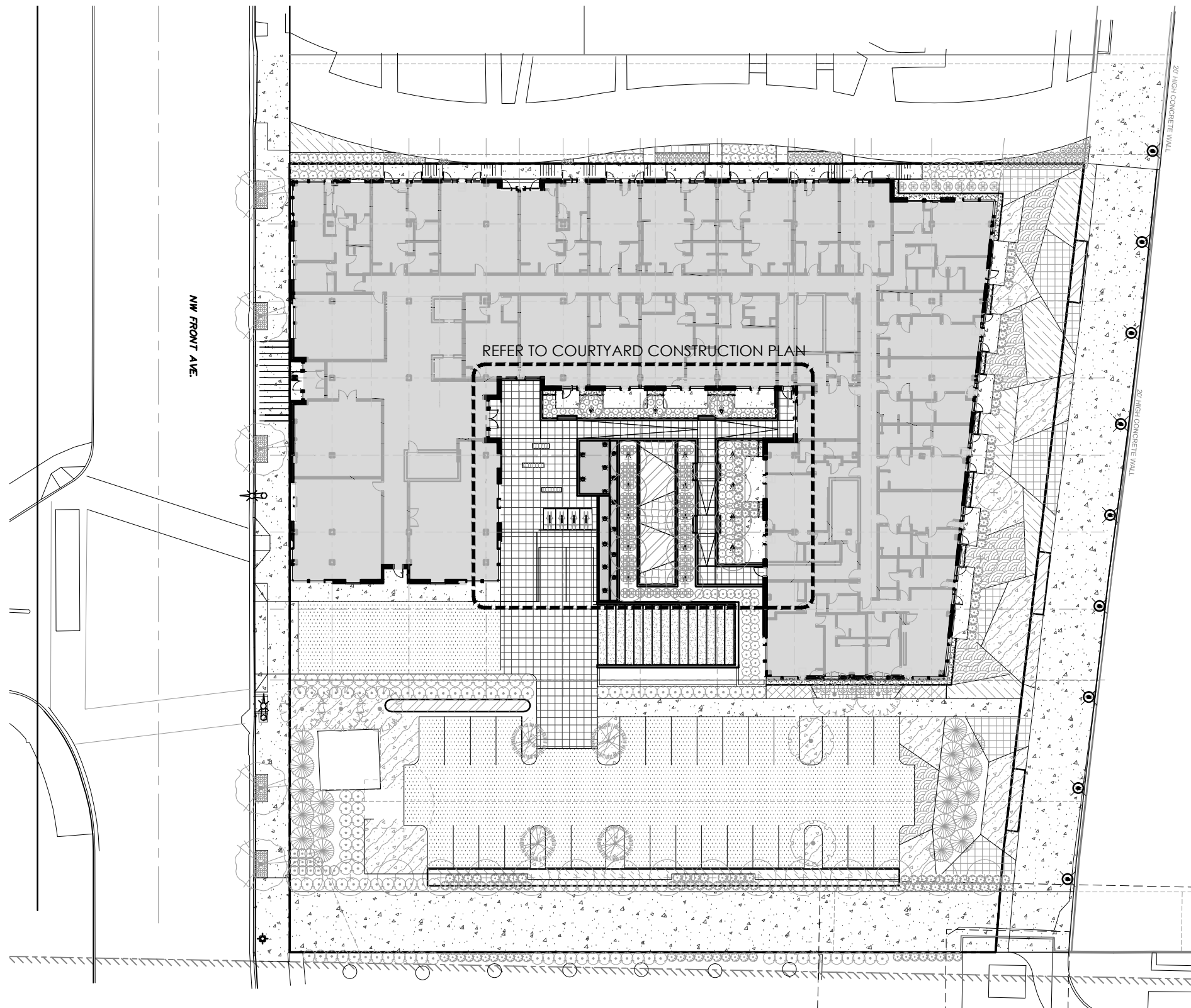

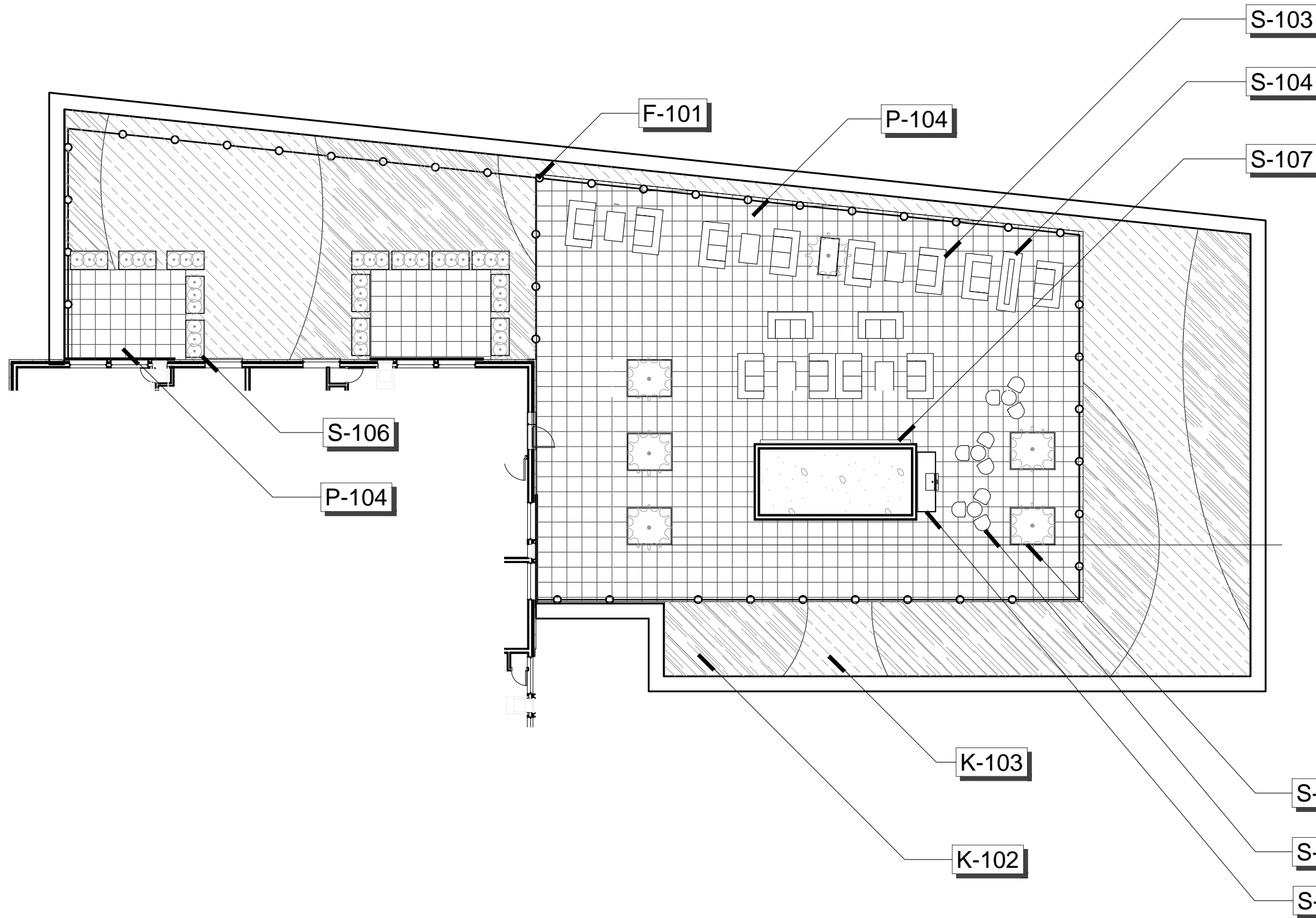





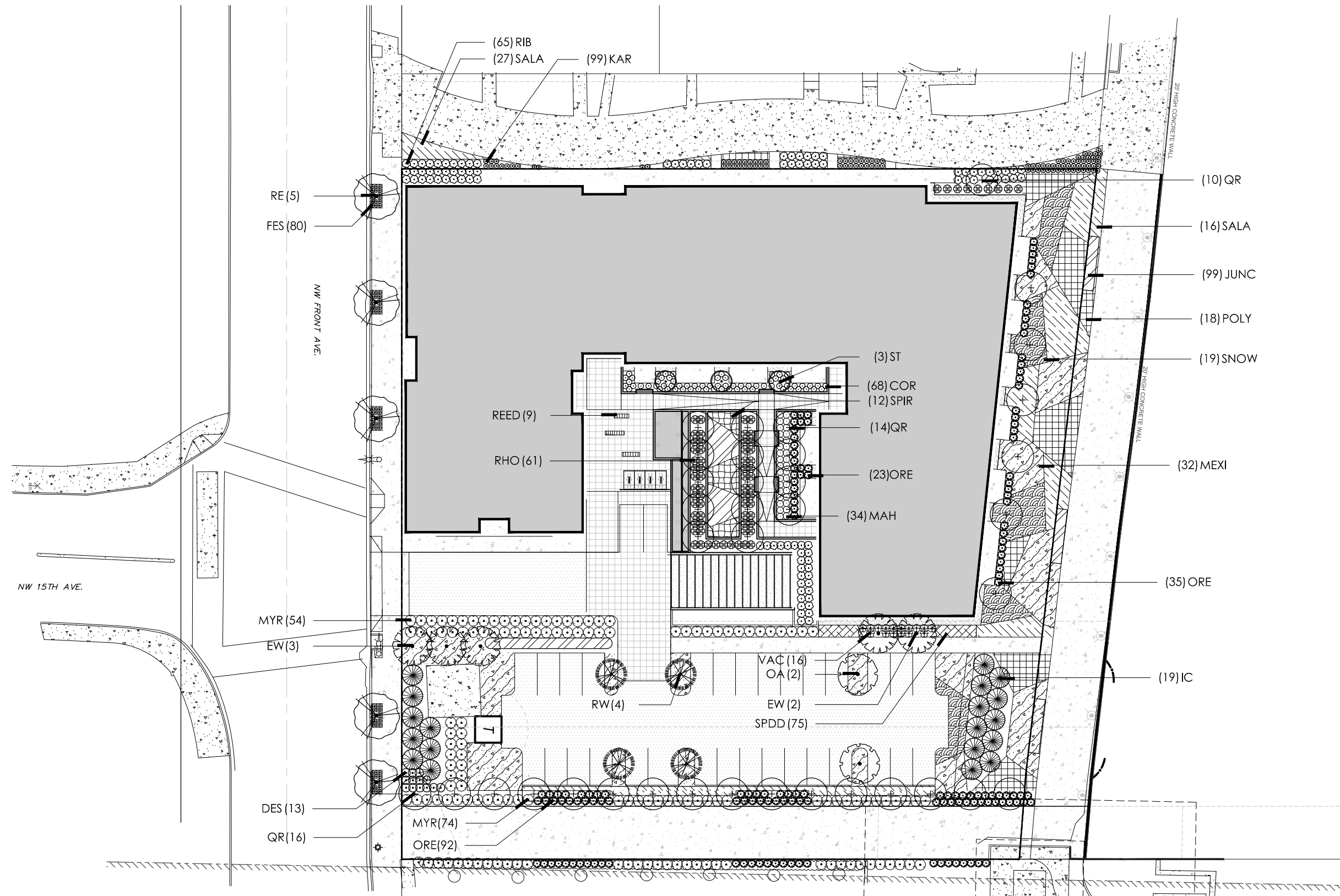

REFERENCE NOTES SCHEDULE

FENCING	
SYMBOL	DESCRIPTION
F-101	GUARDRAIL
ROCK	
SYMBOL	DESCRIPTION
K-102	TYPE 1 GRAVEL - 1 1/2" SIZE WHITE GRAVEL 4" DEPTH SEPARATED WITH METAL EDGING
K-103	TYPE 2 GRAVEL - 1 1/2" SIZE BLACK GRAVEL 4" DEPTH
CONCRETE	
SYMBOL	DESCRIPTION
P-104	PEDESTAL PAVERS
SITE FURNISHINGS	
SYMBOL	DESCRIPTION
S-103	SEATING
S-104	FIRE TABLE
S-105	BBQ GRILLING STATION
S-106	DECORATIVE PLANT CONTAINERS
S-107	MOVIE SCREEN



PLANT SCHEDULE GROUND LEVEL

TREES	CODE	BOTANICAL NAME / COMMON NAME	CONT	CAL	SIZE	QTY
	IC	CALOCEDRUS DECURRENS / INCENSE CEDAR	-		8'-10'	19
	EW	CORNUS NUTTALLII `EDDIE`S WHITE WONDER` / EDDIE`S WHITE WONDER DOGWOOD	B & B	2"	14' - 16'	5
	OA	FRAXINUS LATIFOLIA / OREGON ASH	B & B	2"	14' - 16'	2
	QR	QUERCUS ROBUR `REGAL PRINCE` / REGAL PRINCE ENGLISH OAK	B & B	2" CAL	12-15' H	37
	RE	QUERCUS SHUMARDII / SHUMARD RED OAK	B & B	3.5" CAL	18-20'	5
	RW	SEQUOIA SEMPERVIRENS / COAST REDWOOD	-		10'-12'	4
	ST	STEWARTIA KOREANA / KOREAN STEWARTIA	-	2" CAL	8'-10'	3

SHRUBS	CODE	BOTANICAL NAME / COMMON NAME	CONT	SIZE	QTY
	KAR	CALAMAGROSTIS X ACUTIFLORA `AVALANCHE` / FEATHER REED GRASS	1 GAL.		99
	COR	CORNUS SERICEA `KELSEYI` / KELSEYI DOGWOOD	2 GAL		68
	DES	DESCHAMPSIA CALIFORNICA / CALIFORNIA HAIR GRASS	1 GAL.		13
	FES	FESTUCA IDAHOENSIS `SISKIYOU BLUE` / SISKIYOU BLUE FESCUE	1 GAL		80
	ORE	MAHONIA AQUIFOLIUM / OREGON GRAPE	3 GAL		150
	MAH	MAHONIA AQUIFOLIUM `COMPACTA` / COMPACT OREGON GRAPE	1 GAL.		34
	MYR	MYRICA CALIFORNICA / PACIFIC WAX MYRTLE	5 GAL.		140
	RHO	RHODODENDRON YAKUSIMANUM `PRINCE` / YAKU PRINCE RHODODENDRON	24"		70
	RIB	RIBES SANGUINEUM / RED FLOWERING CURRANT	1 GAL.		93
	VAC	VACCINIUM OVATUM / EVERGREEN HUCKLEBERRY	5 GAL		16

GROUND COVERS	CODE	BOTANICAL NAME / COMMON NAME	CONT	SPACING	QTY
	REED	EQUISETUM HYEMALE / HORSETAIL REED GRASS	1 GAL	12" o.c.	32
	SALA	GAULTHERIA SHALLON `SNOQUALMIE PASS` / DWARF SALAL	1 GAL	30" o.c.	313
	JUNC	JUNCUS EFFUSUS / SOFT RUSH	1 GAL	12" o.c.	702
	MEXI	NASELLA TENUISSIMA / MEXICAN FEATHER GRASS	1 GAL	30" o.c.	584
	POLY	POLYSTICHUM MUNITUM / WESTERN SWORD FERN	1 GAL	24" o.c.	377
	SPDD	SPIRAEA DENSIFLORA / SUB-ALPINE SPIRAEA	2 GAL	12" o.c.	148
	SPIR	SPIRAEA DOUGLASII / WESTERN SPIREA	1 GAL	30" o.c.	45
	SNOW	SYMPHORICARPOS ALBUS `MAGIC BERRY` / COMPACT SNOWBERRY	1 GAL	36" o.c.	132

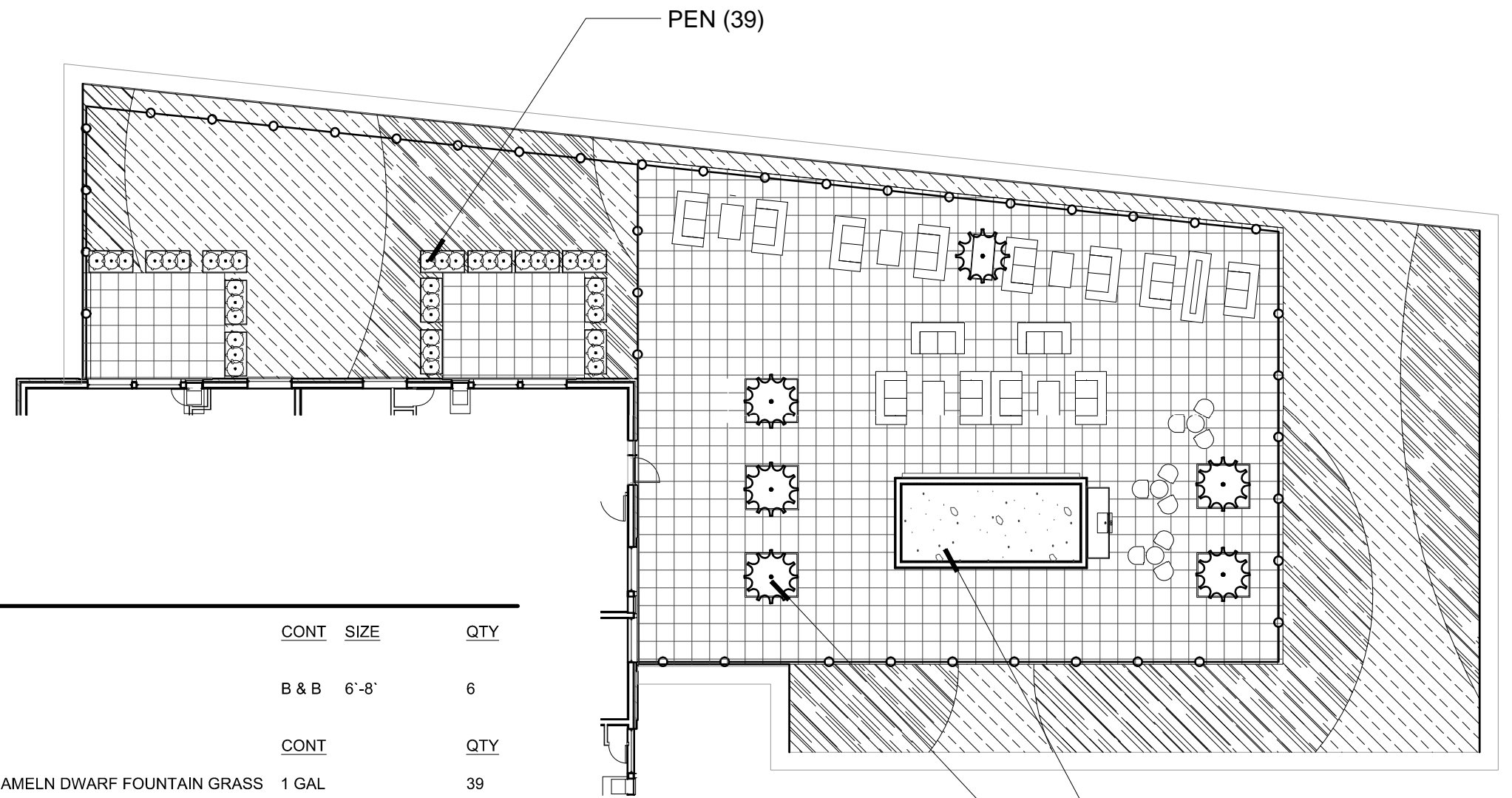

PLANT SCHEDULE ROOFDECK

TREES	CODE	BOTANICAL NAME / COMMON NAME	CONT	SIZE	QTY
	PC	PINUS CONTORTA / SHORE PINE	B & B	6'-8'	6
SHRUBS	CODE	BOTANICAL NAME / COMMON NAME	CONT	QTY	
	PEN	PENNISETUM ALOPECUROIDES 'HAMELN' / HAMELN DWARF FOUNTAIN GRASS	1 GAL	39	
GREEN ROOF	CODE	BOTANICAL NAME / COMMON NAME	CONT	QTY	
	SEDU	SEDUM TILES / SEDUM PREGROWN SEDUM TILES BY "COLUMBIA GREEN" - "ALL SEASON" SEDUM MIX	NONE	174 SF	

NOTE: SEE ECOROOF PLANTING PLAN FOR FULL SEDUM SPECIES LIST

SEDU (174 SF)

PC (6)

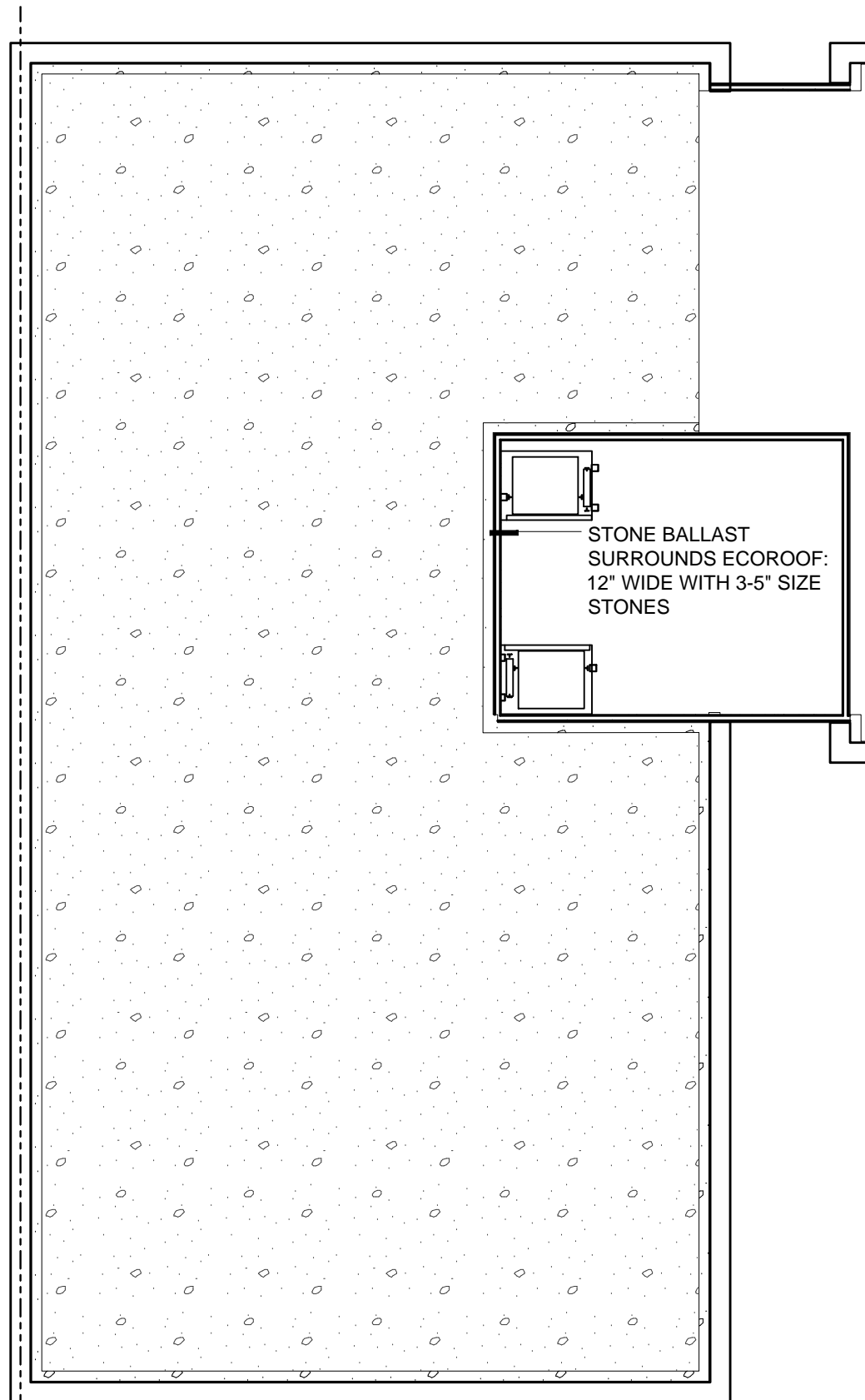

PLANT SCHEDULE ECOROOF

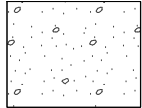
GREEN ROOF	BOTANICAL NAME / COMMON NAME	QTY
	SEDUM TILES / SEDUM PREGROWN SEDUM TILES BY "COLUMBIA GREEN" - "ALL SEASON" SEDUM MIX	7,865 SF
1. SEDUM ALBUM 'CORAL CARPET' / WHITE STONECROP	CREECH CAUCASIAN STONECROP	
2. SEDUM HISPANICUM 'IMMERGRUNCHEN' / SPANISH STONECROP	9. SEDUM SPURIUM 'RED CARPET' / RED CARPET CAUCASIAN STONECROP	
3. SEDUM FLORIFERUM / ORANGE STONECROP	10. SEDUM SPURIUM 'ROSEUM' / 'ROSEUM' CAUCASIAN STONECROP	
4. SEDUM MIDDENDORFFIANUM DIFFUSUM / CHINESE MOUNTAIN STONECROP	11. SEDUM STEFCO / STEFANOV STONECROP	
5. SEDUM REFLEXUM 'GREEN SPRUCE' / SPRUCE STONECROP	12. SEDUM TAKESIMENSIS 'GOLDEN CARPET' / GOLDEN CARPET SEDUM	
6. SEDUM SPURIUM 'COCCINEUM' / RED CAUCASIAN STONECROP	13. SEDUM TETRACTINUM 'CORAL REEF' / FISH SCALE SEDUM	
7. SEDUM SPURIUM 'FULDAALUT' / CAUCASIAN STONECROP		
8. SEDUM SPURIUM 'JOHN CREECH' / JOHN		

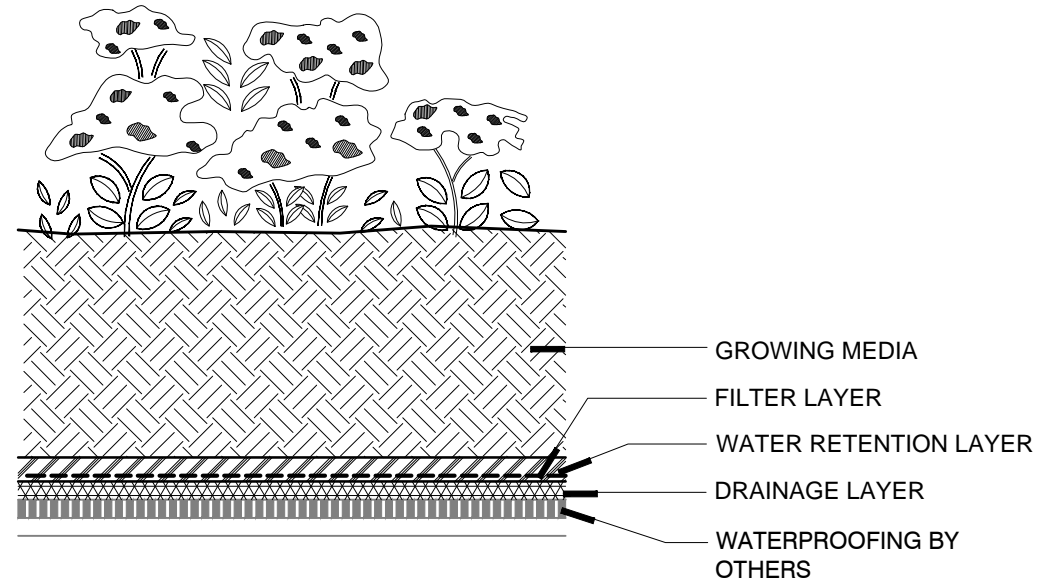



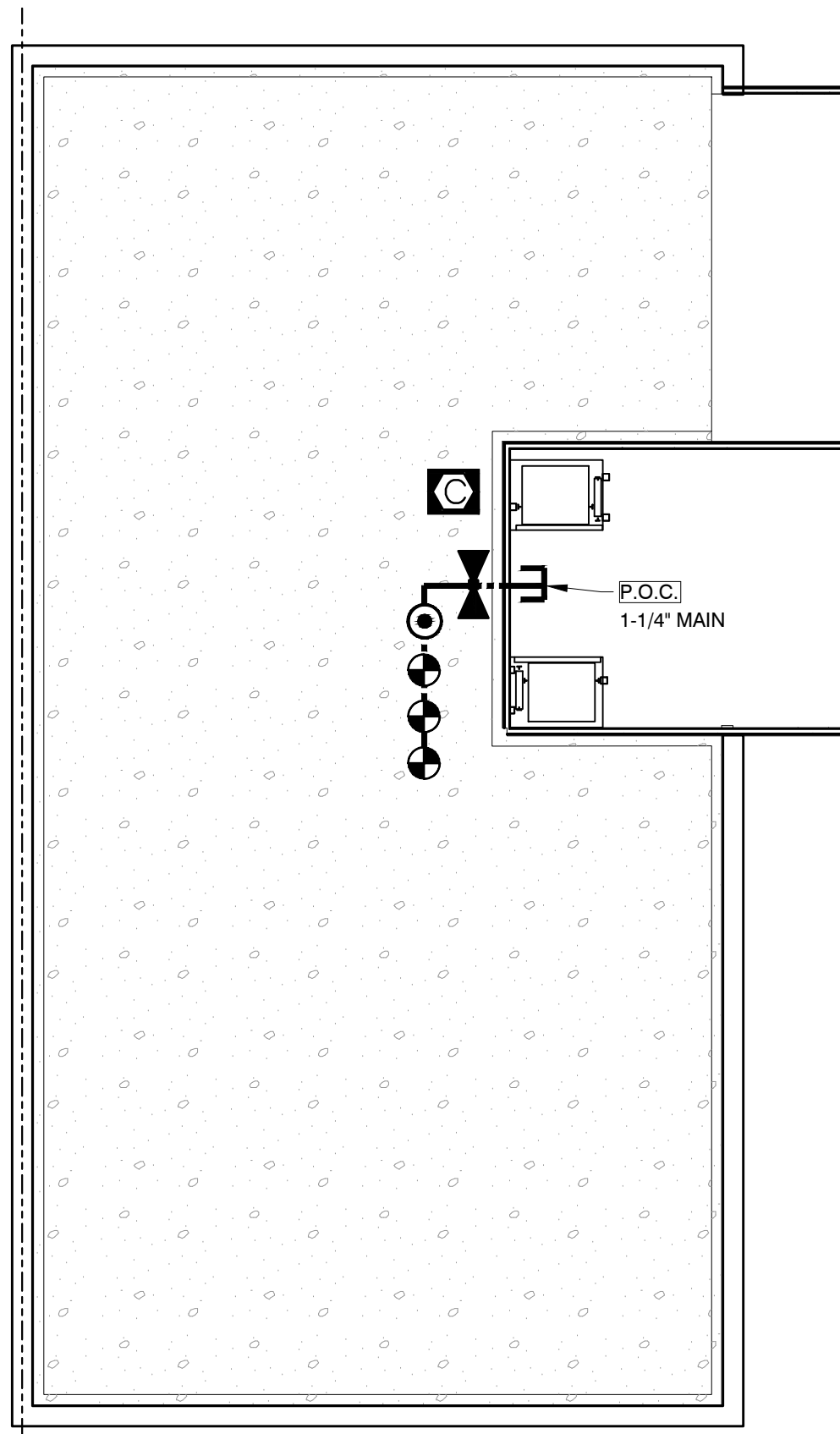

NOTE:
1. SYSTEM COMPONENTS ARE SHOWN AT NOMINAL SIZE, COMPRESSION WILL OCCUR AT RETENTION LAYER BASED ON AMOUNT (HEIGHT/VOLUME) OF GROWING MEDIA PLACED ON SYSTEM. MAXIMUM COMPRESSION 1/4" ±.

1 ECO-ROOF
SCALE: 1/16" = 1'-0"

2 ECO-ROOF DETAIL
SCALE: NTS



IRRIGATION LEGEND

	PROPOSED IRRIGATION MAINLINE
	POINT OF CONNECTION
	AUTOMATIC CONTROL VALVE
	QUICK COUPLER
	AUTOMATIC "SMART" CONTROLLER FINAL LOCATION TO BE DETERMINED



Ecoroofs are vegetated systems that retain and filter stormwater and provide aesthetic and energy conservation benefits. The extensive ecoroof filters stormwater with a plant palette composed primarily of sedum plants.

Soil medium, vegetation, irrigation, and drains shall be inspected for proper operations throughout the life of the ecoroof. All elements shall be inspected annually. Facilities personnel shall keep a log, recording all inspection dates, observations, and maintenance activities. Work orders and invoices shall be kept on file and made available to City inspector upon request. The following items shall be inspected and maintained as stated:

Soil Substrate / Growing Medium shall sustain healthy plant cover and infiltrate within 48 hours.

- Growing medium shall be inspected for evidence of erosion from wind, water or settlement. If erosion channels are evident, they shall be stabilized with additional soil substrate/growth medium and covered with additional plants. All depressions as the result of maintenance foot traffic activity, settlement, etc. shall be filled flush with adjacent medium. Plant mortality as a result of foot traffic shall be replaced immediately. Bare soil shall be planted per the planting design. Soil shall drain within 48 hours.

Eco-roof System shall be operated and maintained in accordance with manufacturer's requirements. Drain inlets shall be kept unrestricted.

- Inlet pipe shall be cleared when soil substrate, vegetation, debris, litter or other materials clog the drain inlet. Sources of sediment and debris shall be identified and corrected.
- Determine if drain inlet pipe is in good condition and correct as needed.
- contact membrane manufacturer if tears or perforations are found in the membrane.

Vegetation shall be maintained to provide 95% plant cover.

- During the Establishment Period, dead or damaged plants shall be replaced by contractor once per month as needed until expiration of warranty after which the Owner or building facilities shall be responsible for maintenance. During the long-term period, dead plants shall generally be replaced once per year in the fall months.
- Fallen leaves and debris from deciduous plant foliage shall be removed.
- Nuisance and prohibited vegetation from the Portland Plant List shall be removed when discovered.
- Weeding shall be manual with no herbicides or pesticides used. Weeds shall be removed regularly and not allowed to accumulate.

Irrigation of Extensive eco-roof

- During the Establishment period (2 years), the irrigation timer shall be set to assure plant establishment at a rate of .25 inch every 14th day during the months of June and September (warm periods) and .25 inch every seventh day during July and August (hot dry periods).
- During the long-term period (after 2 full years), water at a rate of .25 inch every 14th day during the months of July and August to maintain plant cover. No irrigation is allowed from the beginning of November through the end of April.
- Irrigation watering times shall be modified as needed to accommodate fluctuations in dry and wet periods with the exception that at no time shall the irrigation exceed .5 inches per ten days. Accurate monitoring and assessment of temperature and rainfall shall dictate schedule and watering lengths. Automatic rain shut off devices are to be inspected and any debris removed during irrigation regime.

Spill prevention measures from mechanical systems located on roofs shall be exercised when handling substances that can contaminate stormwater.

- Release of pollutants shall be corrected as soon as identified.
- Best management practices shall be implemented to prevent hazardous wastes from contaminating stormwater. Record time, date, weather, and site conditions when site activities contaminate stormwater.

Training and/or written guidance information

- A copy of O&M Plan for maintaining ecoroofs shall be provided to the Owner's maintenance personnel for reference. Building facilities / maintenance personnel shall receive instruction as to needs and regular schedules for properly maintaining the health and vigor of the eco-roof plantings and associated drainage surface.

Access and Safety to the eco-roof

- No tenant circulation or egress routes are proposed or allowed on extensive ecoroof areas. Maintenance personnel shall access roof via utility access points and tie into safety points as needed when inspecting or maintaining perimeter areas that pose a safety concern.

Aesthetics of the eco-roof shall be maintained as an asset to the property owner and community.

- Evidence of damage or vandalism shall be repaired and accumulation of trash debris shall be removed upon discovery.

Insects shall not be harbored at the eco-roof.

- Standing water creating an environment for development of insect larvae shall be eliminated by manual means. Chemical sprays shall not be used.
- Record time, date, weather, and site conditions when insect or rodent activity is observed. Record when insect or rodent activity abated or ended.

Annual Maintenance Schedule:

Summer: Make necessary repairs. Improve growing medium as needed. Clear drains. Irrigate as described above.

Fall: Replace exposed soil and dead plants. Remove sediment and debris from drains. Provide erosion control for base soil if necessary.

Winter: Monitor infiltration/flow rates. Clear drains as needed.

Spring: Replant exposed soil and dead plants. Removed sediment and debris from drains.

All Seasons: Weed as necessary.

Plant Palette - Shrubs



English Yew



California Wax Myrtle



'Yaku Princess' Rhododendron- spring blooms



Oregon Grape



Compact Oregon Grape



Dwarf Salal



Douglas Spirea



Red-flowering Currant



Kelsey Redtwig Dogwood



Compact Snowberry



Sub-Alpine Spirea



Evergreen Huckleberry



Western Sword Fern

Plant Palette - Trees, Grasses & Sedums



Incense Cedar



Eddie's White Dogwood



Oregon Ash

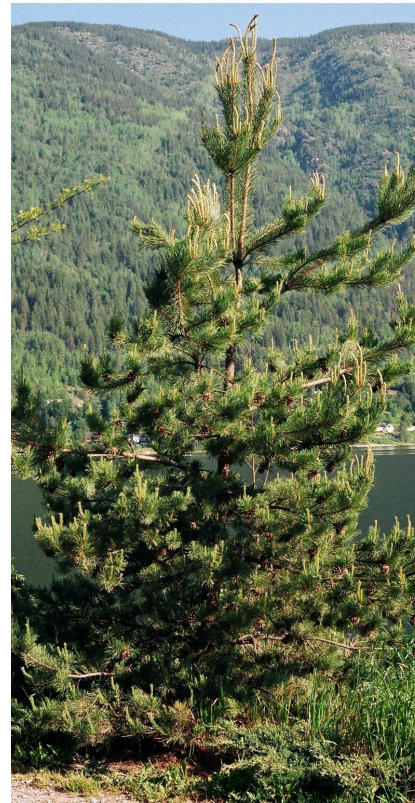

Shore Pine



California Hair Grass



Feather Reed Grass



Siskyou Blue Fescue



Regal Prince Oak



Shumard Oak



Coast Redwood



Korean Stewartia (fall color shown)



Dwarf Fountaingrass



Horsetail Grass



Soft Rush



Mexican Feathergrass



Mixed Sedum Cuttings- greenroof

Ground Level Furnishings & Materials

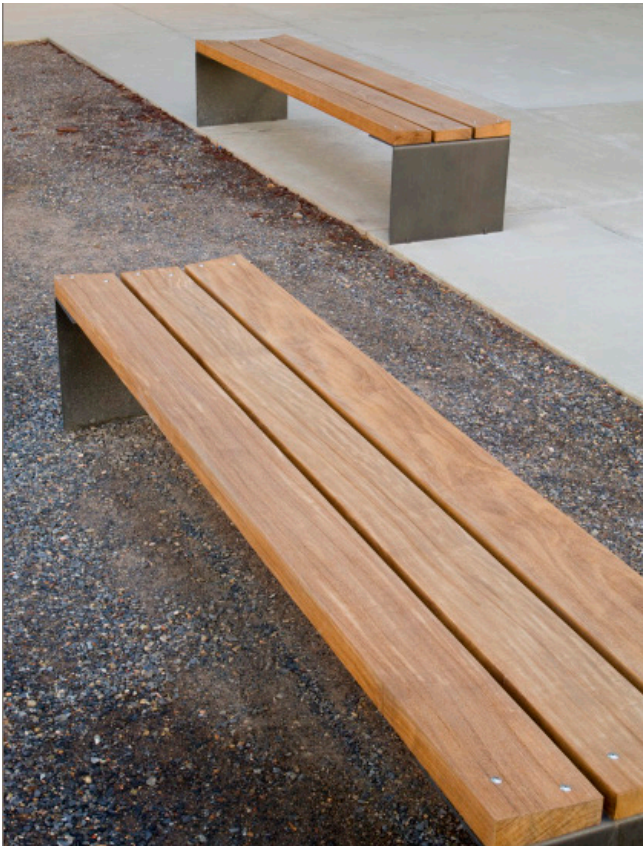

Courtyard Bench



Greenway light fixture



Metal structure above garage ramp



Underwater light for courtyard water feature



Uplight fixtures



Uplighting on trees



Permeable concrete pavers: Mutual Materials Eco-Prioria



Bike racks

Roof Deck Furnishings & Materials



Outdoor movie screen



Steel planter boxes



Furniture



Steel fire table



White gravel



Black gravel



Concrete pedestal pavers

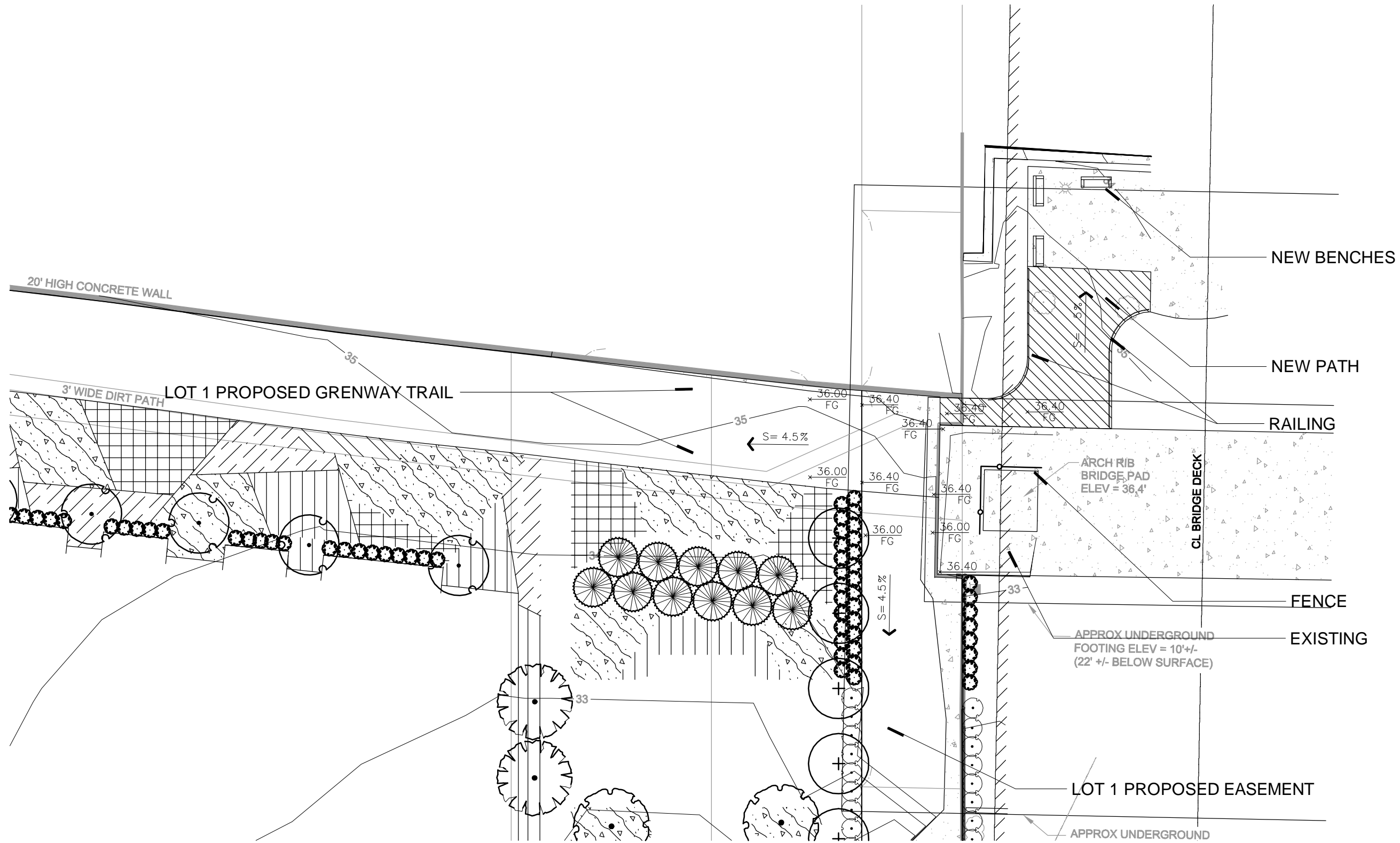

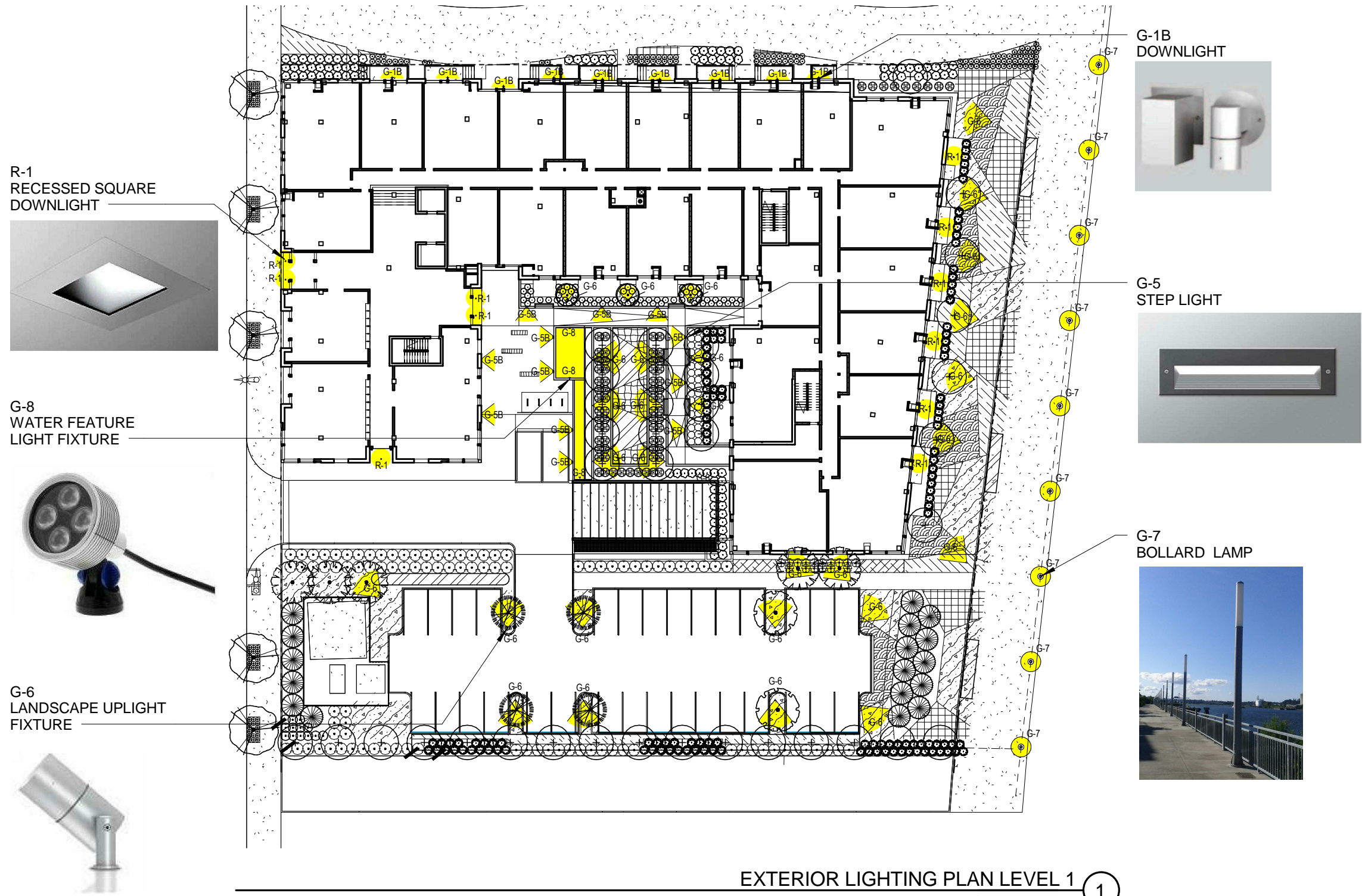

EXTERIOR LIGHTING PLAN LEVEL 1 1

DR - EXTERIOR LIGHTING FIXTURE SCHEDULE		
TYPE	COUNT	DESCRIPTION
G-1B	9	SQUARE MOUNTED DOWNLIGHT
G-6	29	LANDSCAPE UPLIGHT FIXTURE
G-7	9	BOLLARD LAMP
G-8	3	WATER FEATURE LIGHT FIXTURE, UNIT SIDE SHIELD
R-1	11	RECESSED SQUARE DOWNLIGHT



VTAC LOUVERED COVER



VPI VINYL WINDOW - ENDURANCE

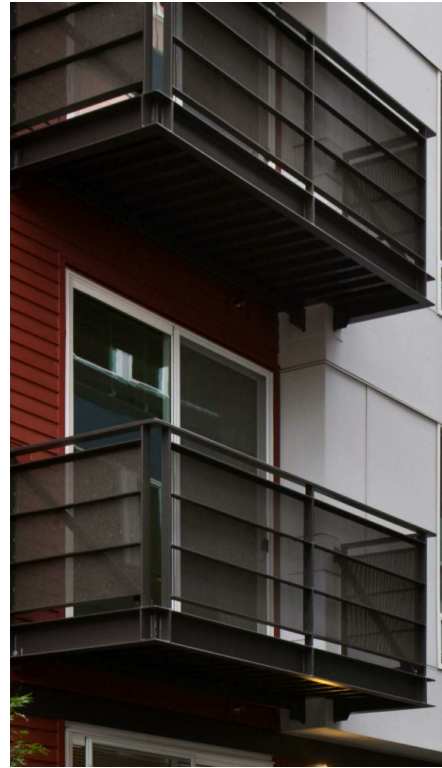

MESH RAILING BALCONY

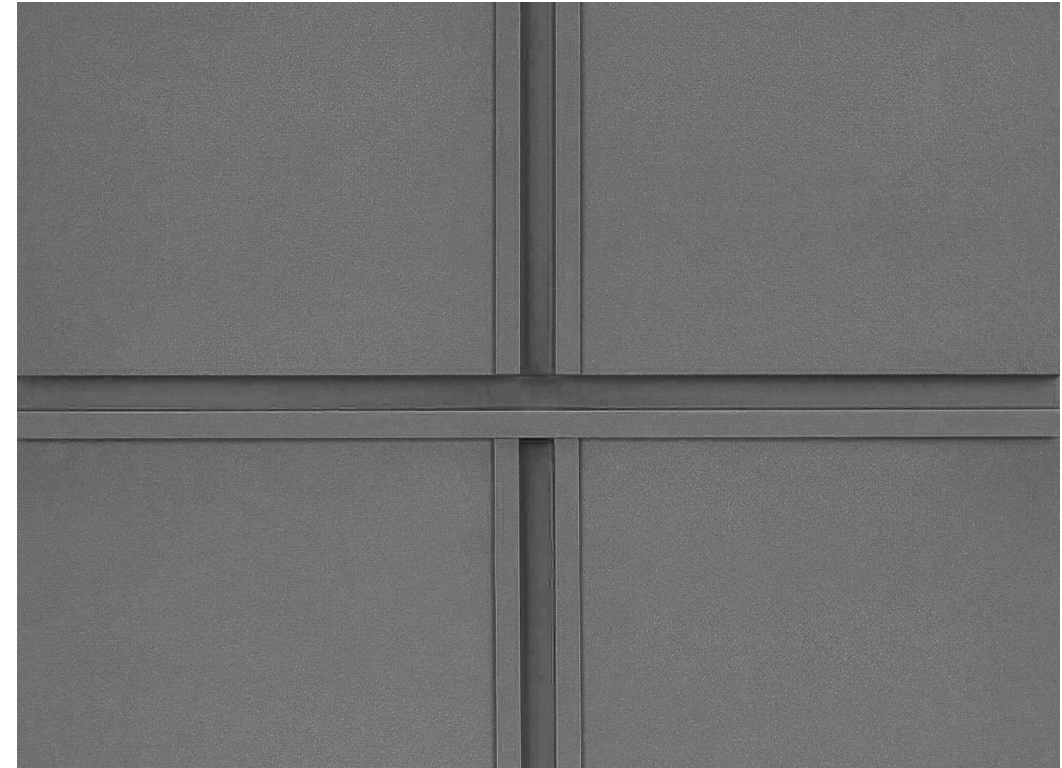

FIBER CEMENT BOARD INFILL BETWEEN WINDOWS



BLACK METAL TRIM



BRICK - MUTUAL MATERIALS "MODIFIED GRANITE" - NORMAN SIZE



STEEL C-CHANNEL LINTEL ABOVE WINDOWS

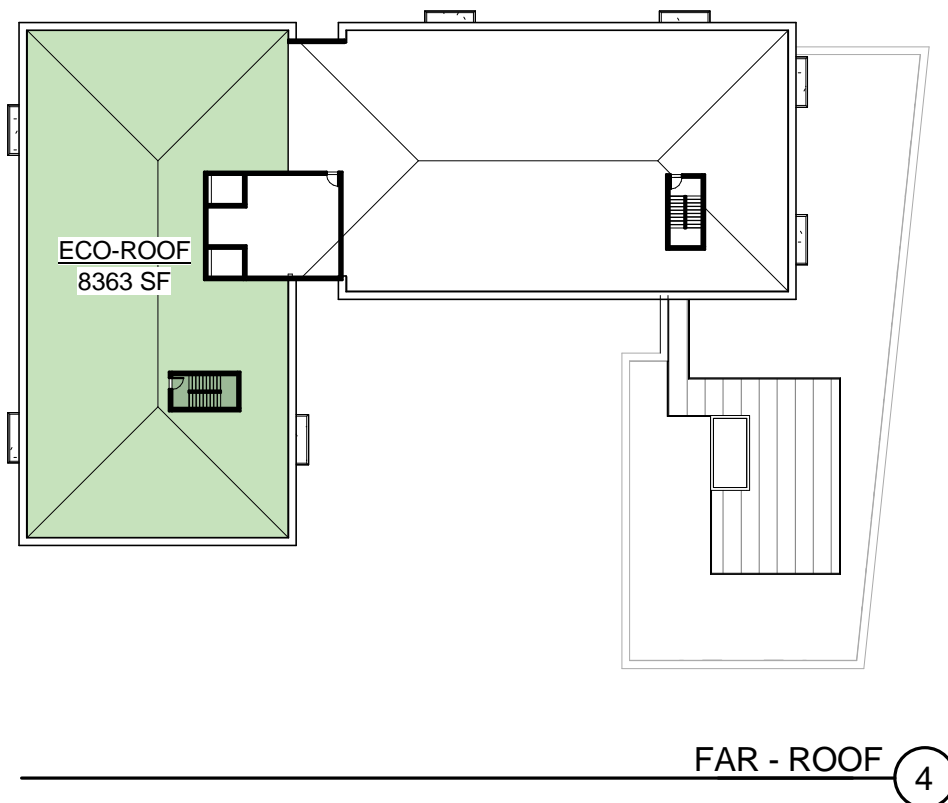
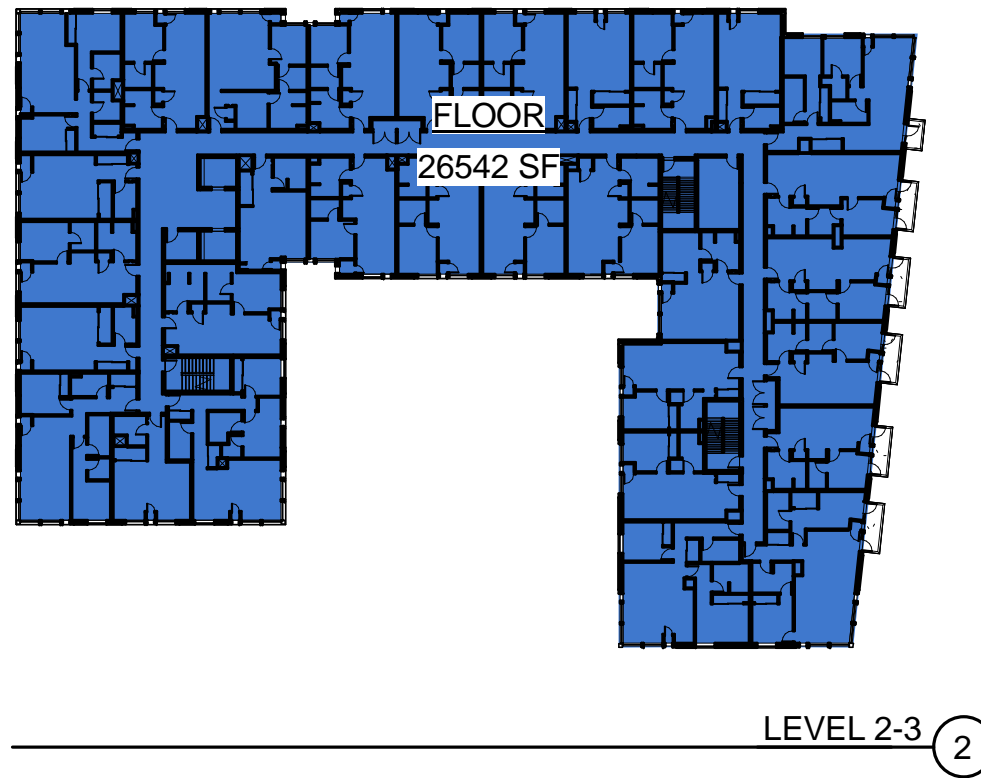

26,545 SF	LEVEL 1
26,545 SF	LEVEL 2
26,545 SF	LEVEL 3
18,385 SF	LEVEL 4
18,385 SF	LEVEL 5
18,385 SF	LEVEL 6
<hr/>	
134,790 SF	FAR TOTAL
129,342 SF	BASE FAR ALLOWABLE (no bonuses)
<hr/>	
8,374 SF	ECO-ROOF BONUS
137,716 SF	FAR TOTAL ALLOWED

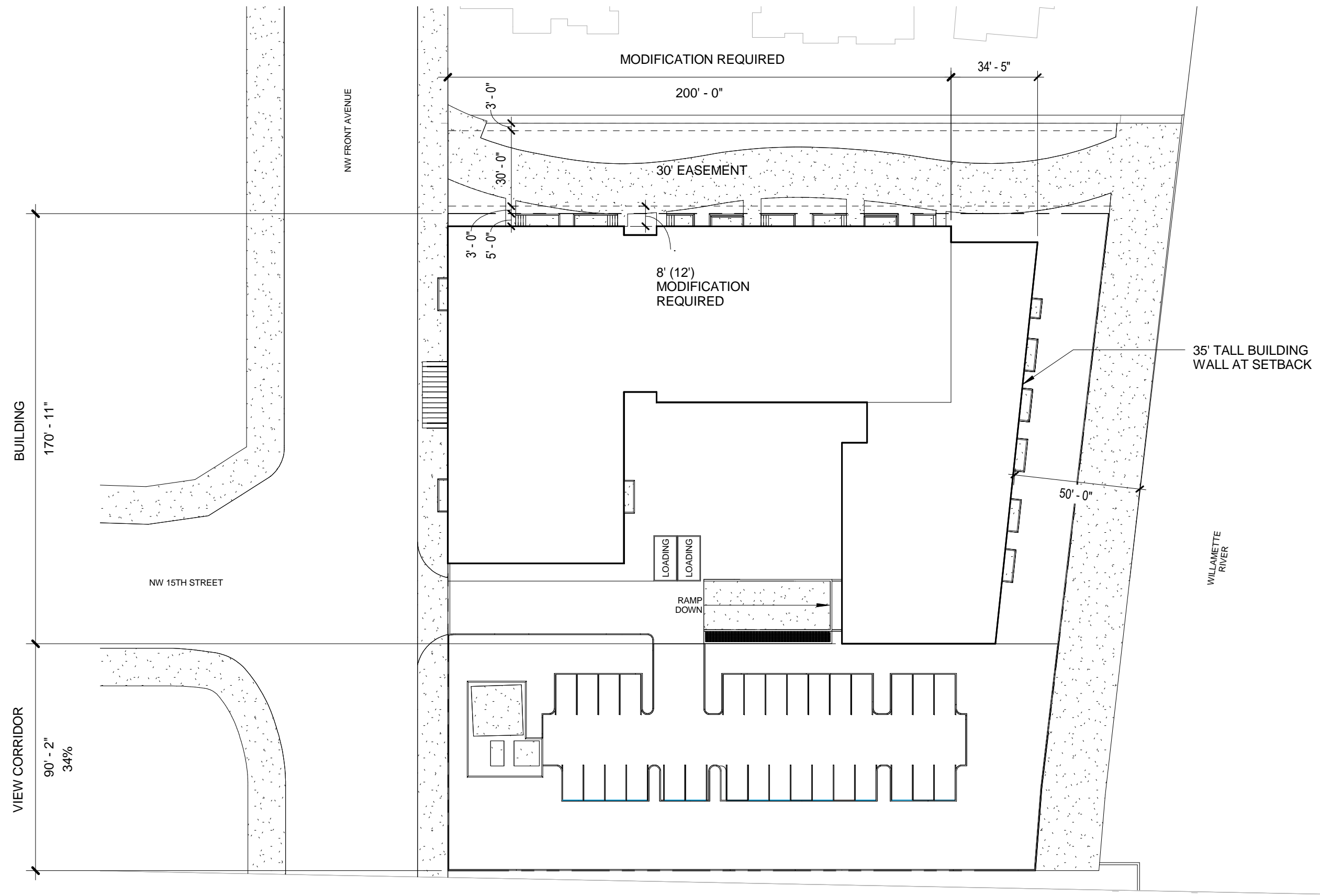

BUILDING
170' - 11"

VIEW CORRIDOR
90' - 2"
34%

NW 15TH STREET

NW FRONT AVENUE

MODIFICATION REQUIRED

200' - 0"

34' - 5"

30' EASEMENT

8' (12')
MODIFICATION
REQUIRED

35' TALL BUILDING
WALL AT SETBACK

WILLAMETTE
RIVER

50' - 0"

LOADING
LOADING

RAMP
DOWN

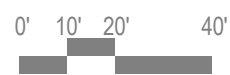

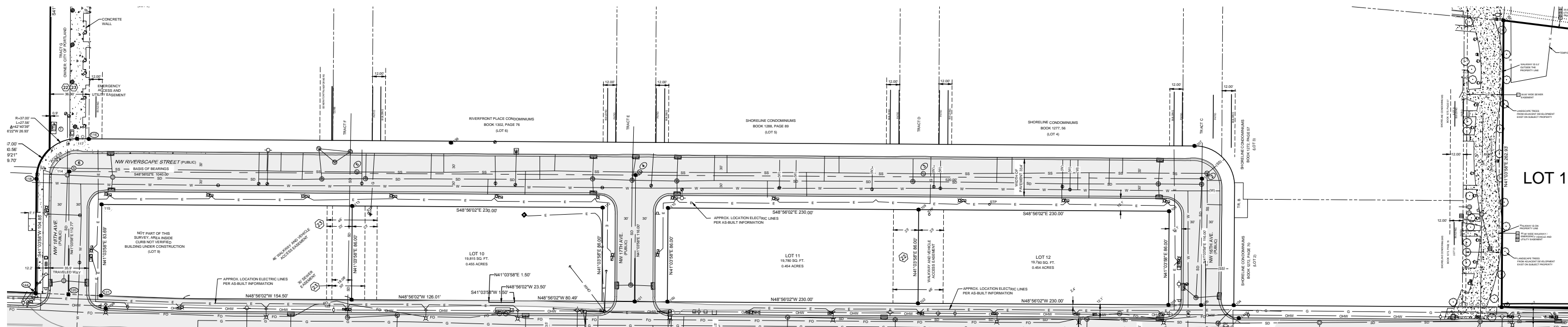

LOT 1



IN-UNIT BICYCLE PARKING





WALL MOUNT RACKS



2 LEVEL RACKS

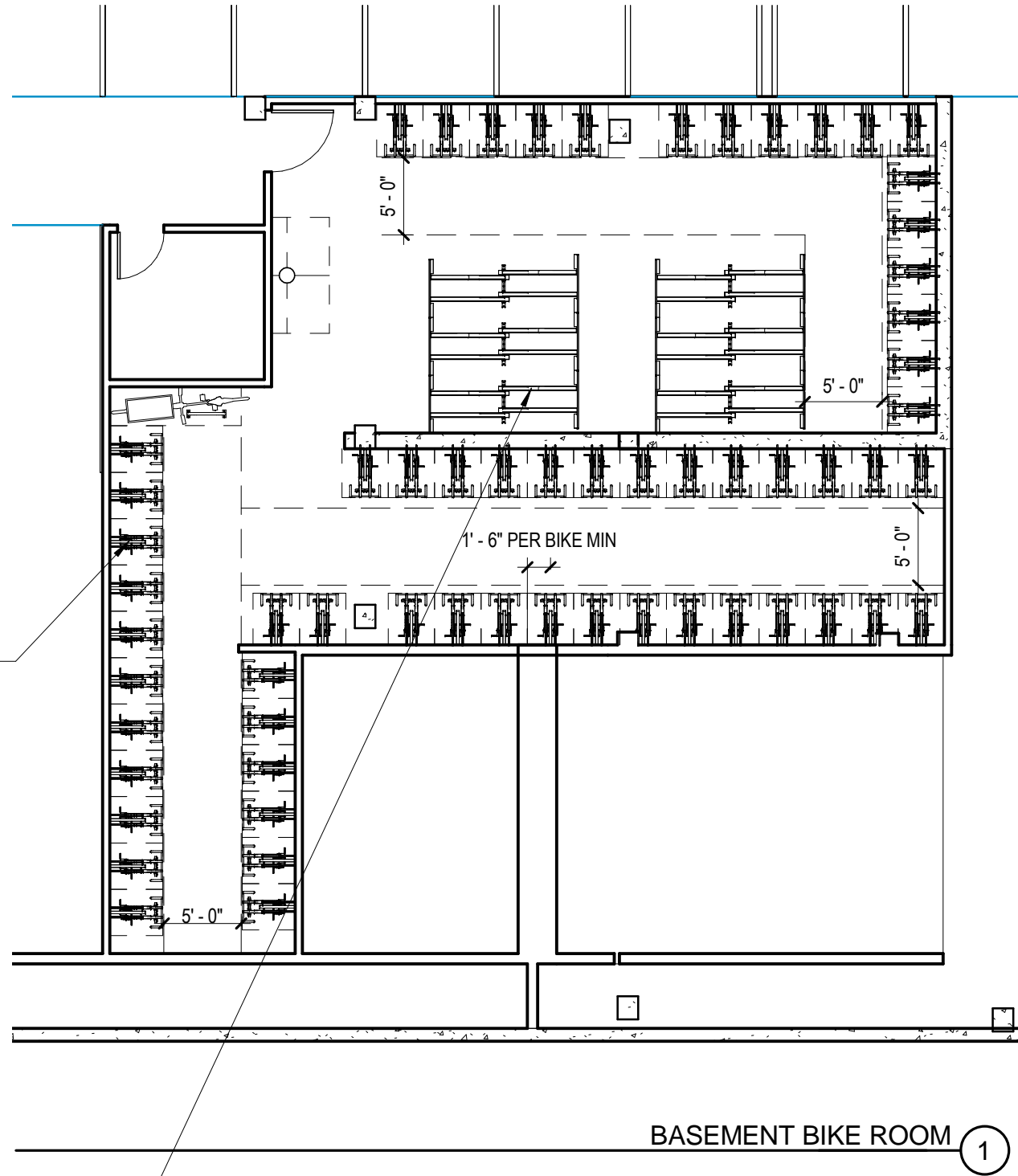

BASEMENT BIKE ROOM 1

BICYCLE PARKING

PER CITY OF PORTLAND PLANNING AND ZONING CODE -
CHAPTER 33.266, TABLE 266-6

LONG TERM BIKE PARKING REQUIREMENT:

RESIDENTIAL: 1.5 SPACES PER UNIT ∴ 149 UNITS X
1.5 = 224 SPACES REQUIRED

(NOTE: 1.5 SPACES PER UNIT IN CENTRAL CITY PLAN
DISTRICT)

SHORT TERM BIKE PARKING REQUIREMENT:

RESIDENTIAL : 1 SPACE PER 20 UNITS ∴ 149 UNITS/
20 = 8 SPACES REQUIRED

BIKE PARKING - LONG TERM - BASEMENT	
TYPE	BIKE COUNT
LONG TERM - 2 LEVEL RACK	48
LONG TERM - CARGO FLOOR MOUNT	1
LONG TERM - WALL MOUNT	122
	171

BIKE PARKING - LONG TERM - UNITS	
TYPE	BIKE COUNT
LONG TERM - SINGLE	76
	76

TOTAL LONG TERM BIKE PARKING 247

BIKE PARKING - SHORT TERM - COURTYARD	
TYPE	BIKE COUNT
SHORT TERM - U-RACK	8
	8

SEE LANDSCAPE PLANS FOR
SHORT TERM PARKING

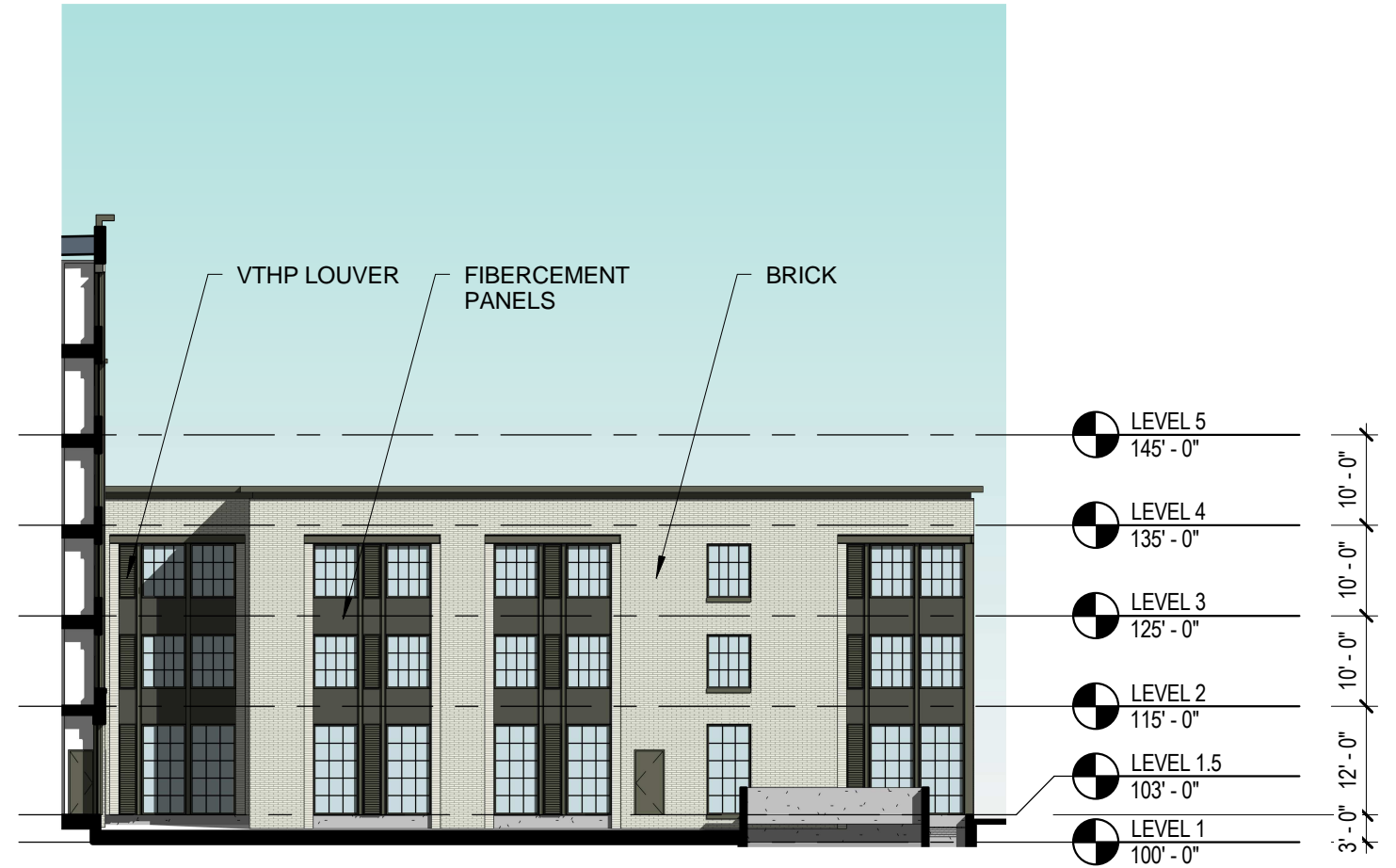
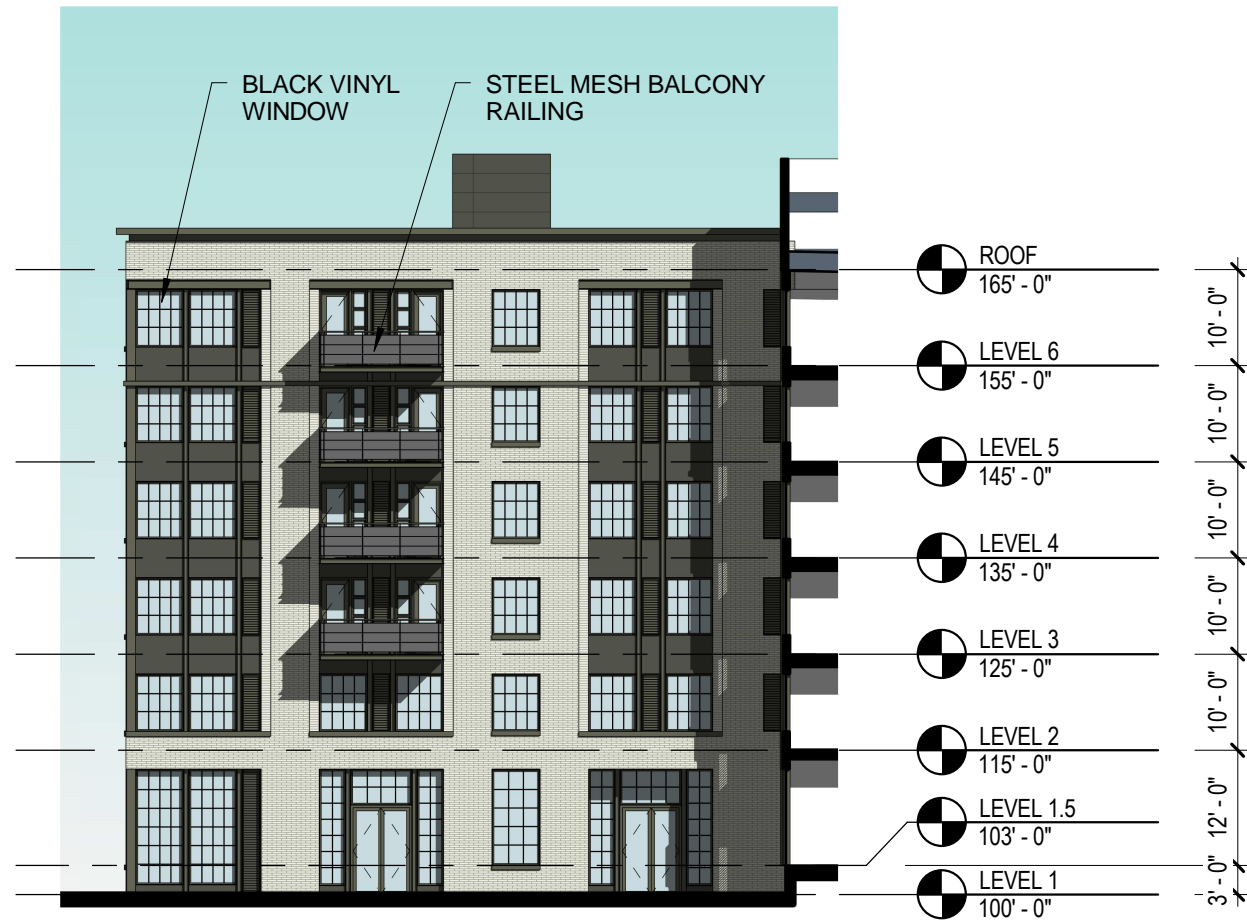

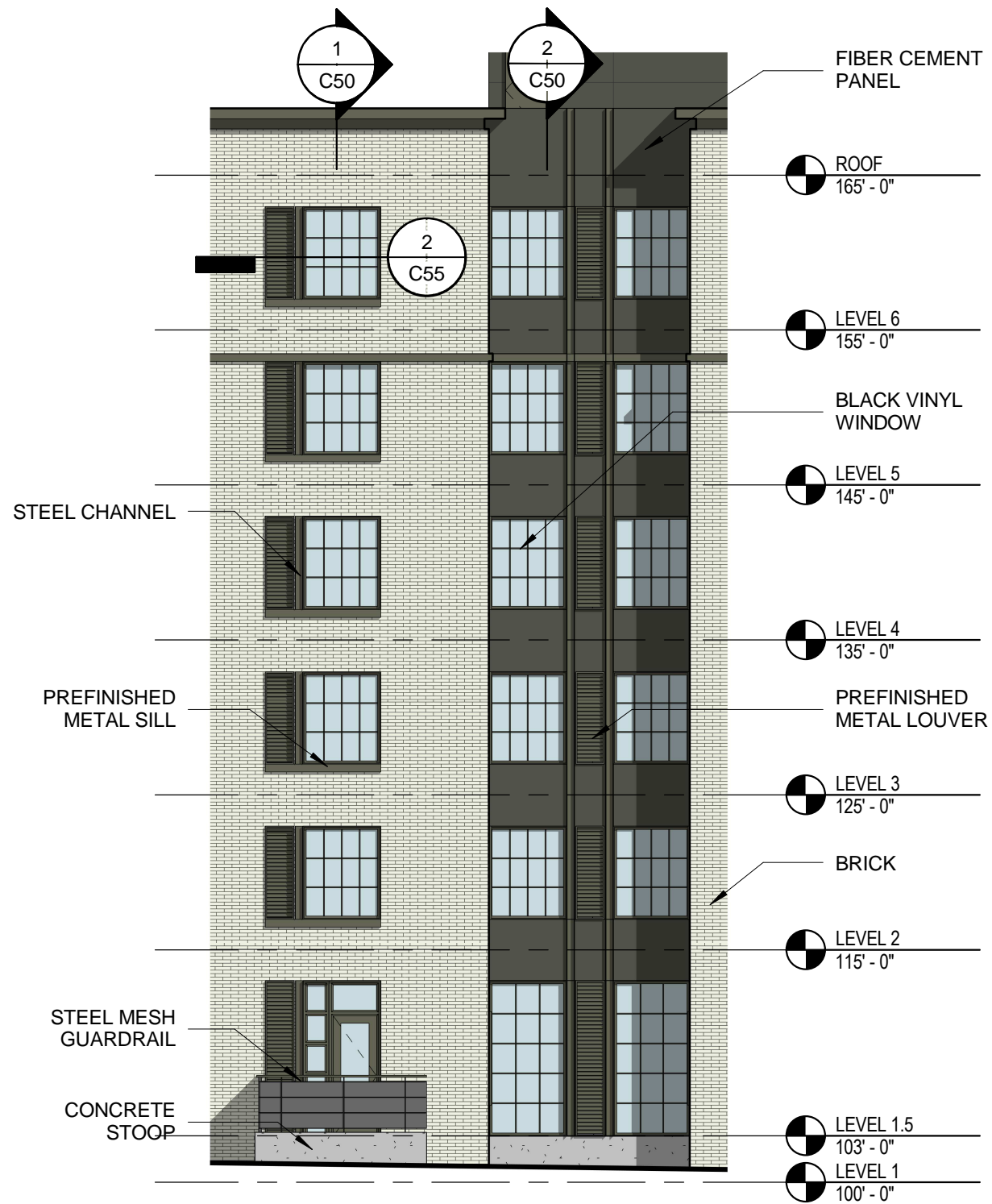

ENLARGED ELEVATION ③

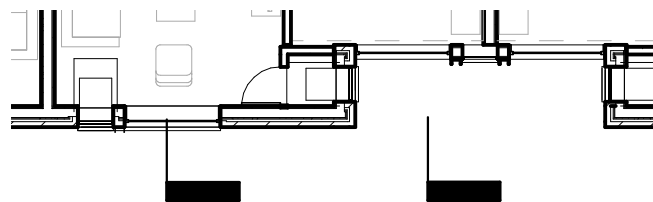

WALL PLAN ④

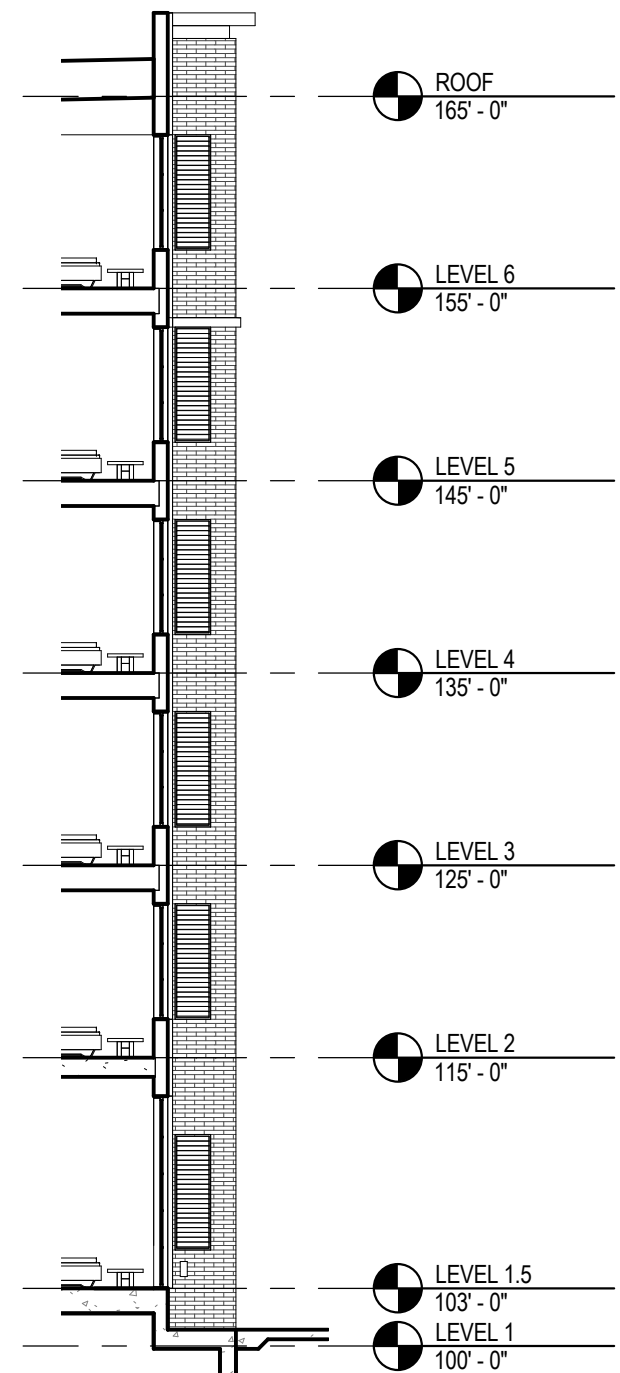

WALL SECTION AT SPLIT ②

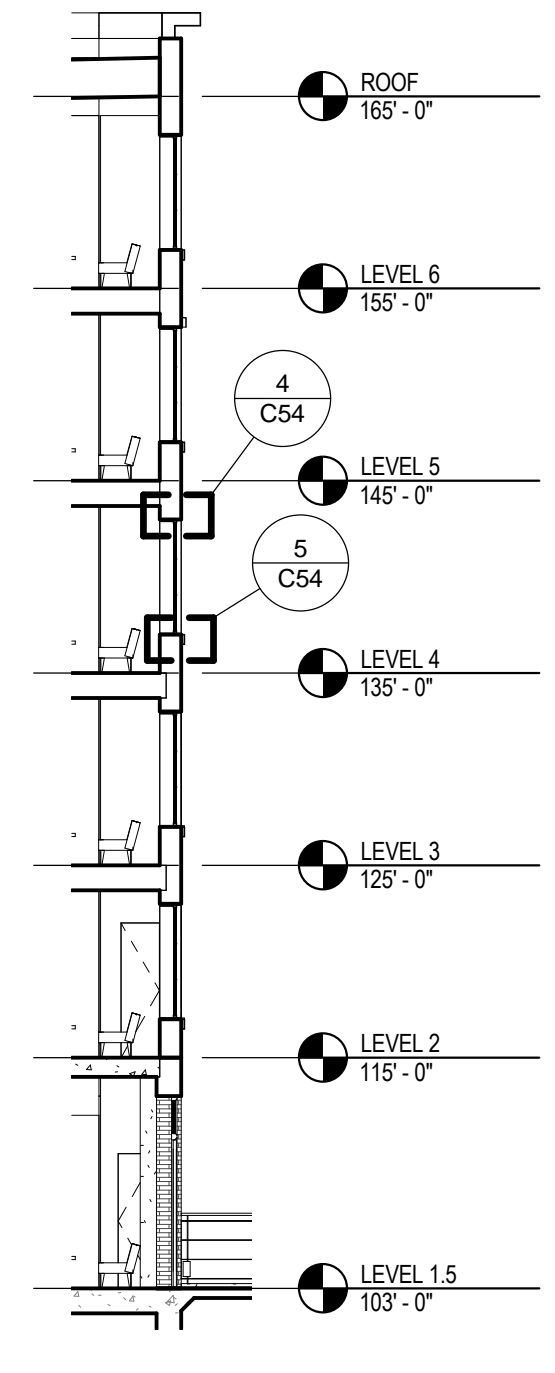

WALL SECTION AT BRICK ①



NORTH BUILDING SPLIT C50

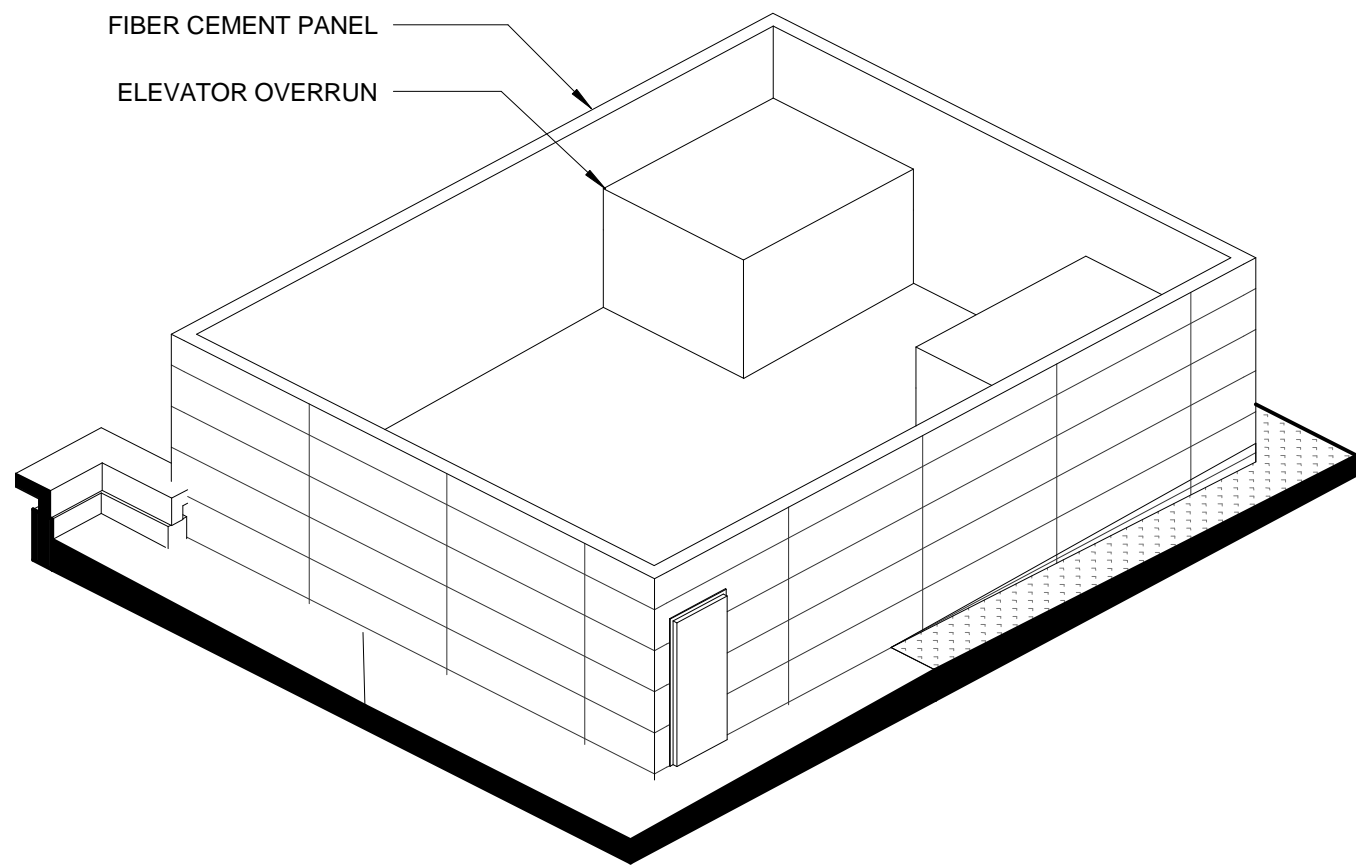

ELEVATOR OVERRUN PERSPECTIVE ②

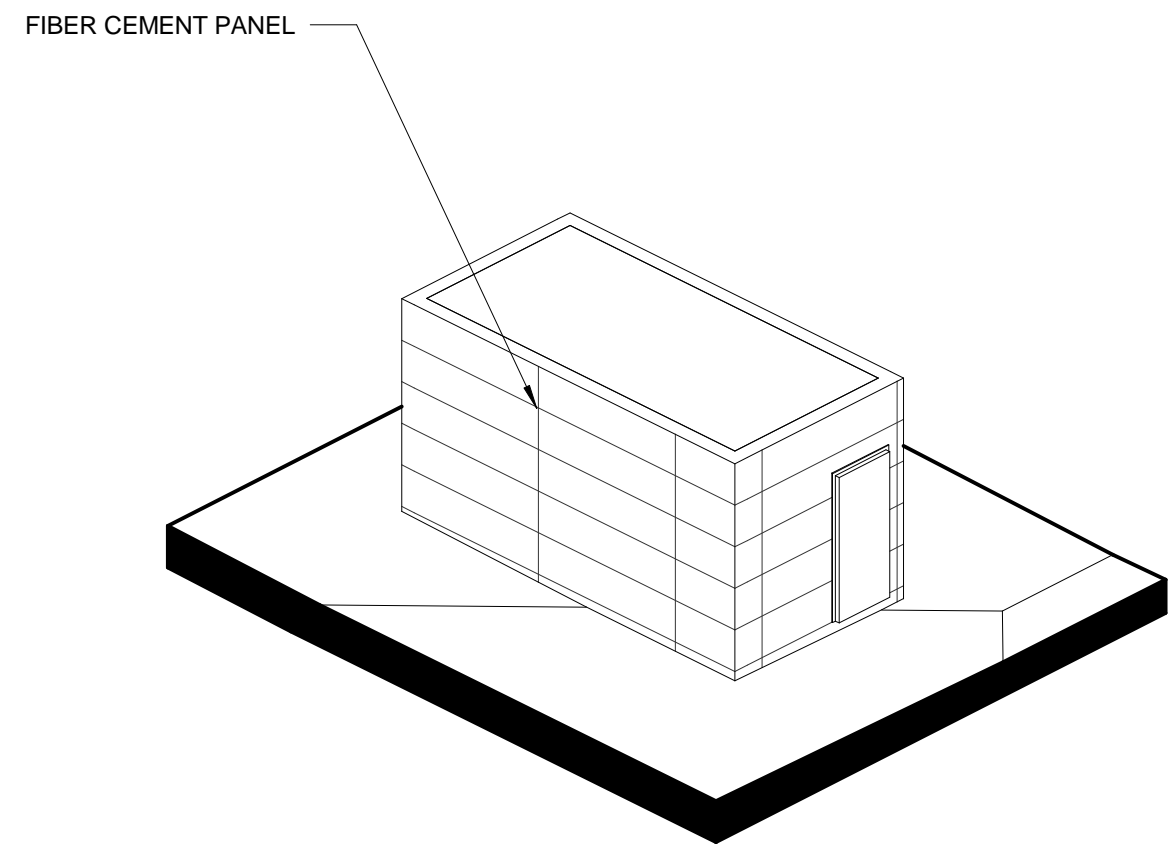

STAIR TOWER PERSPECTIVE ①

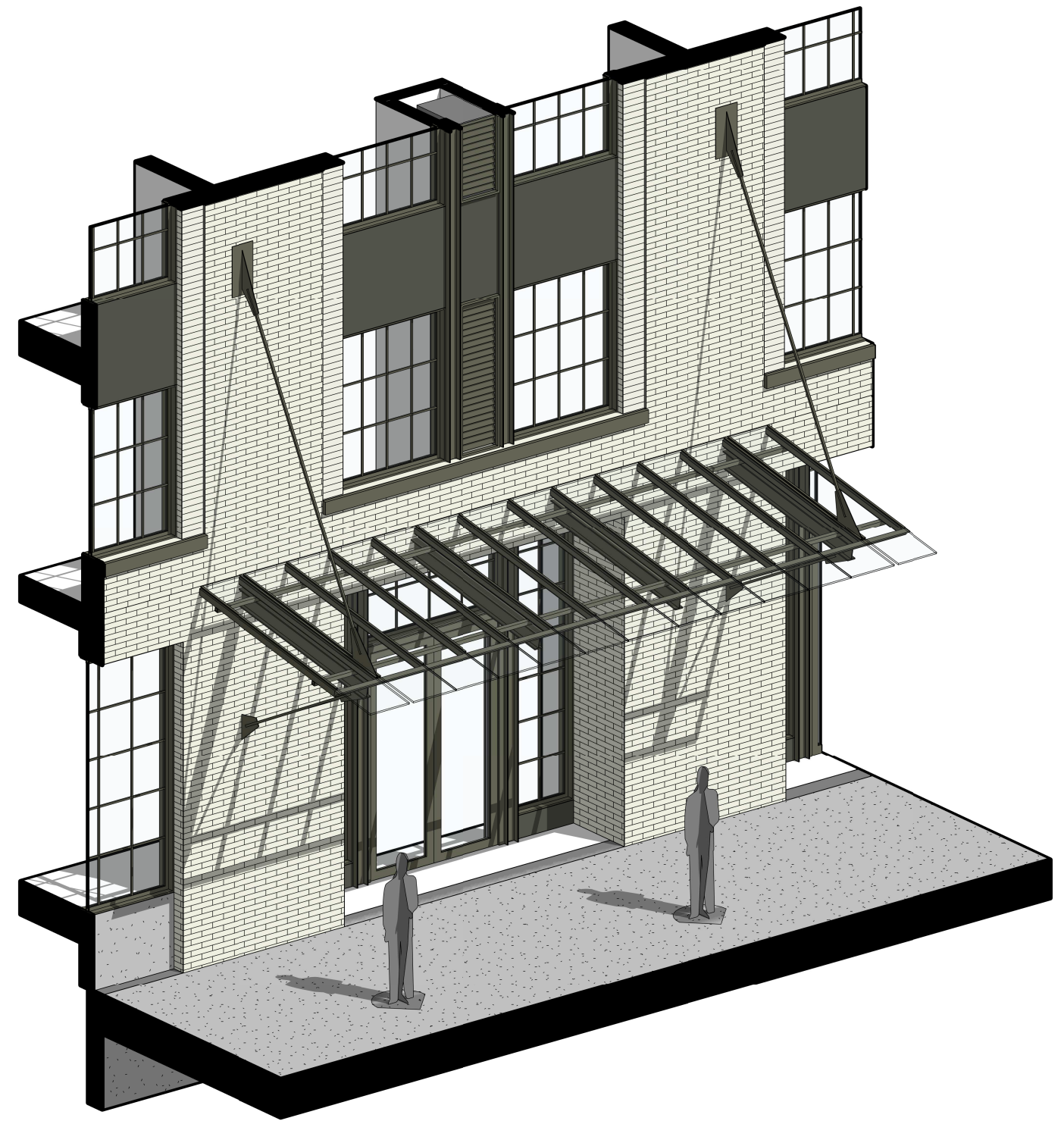
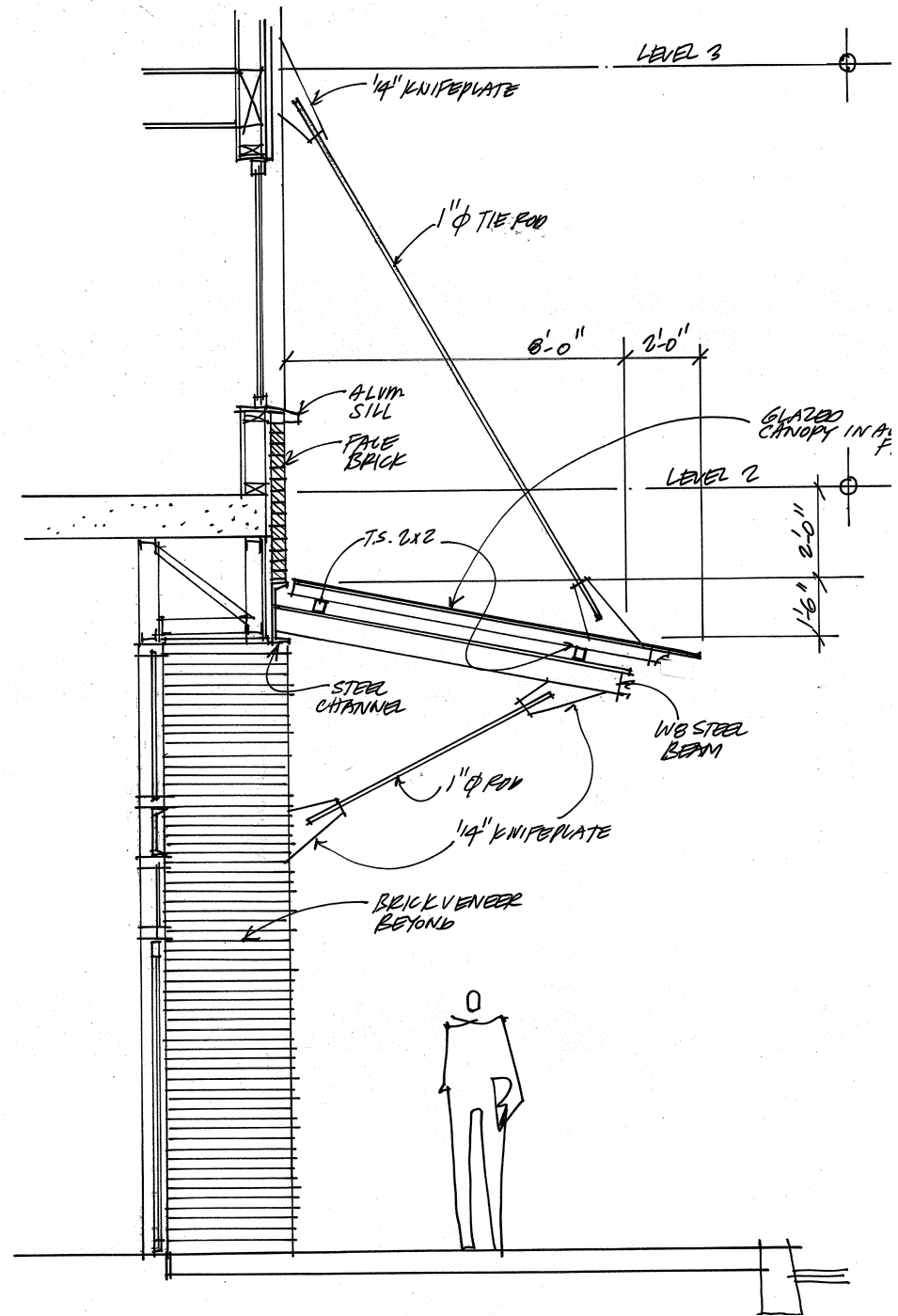

MAIN ENTRY CANOPY 1

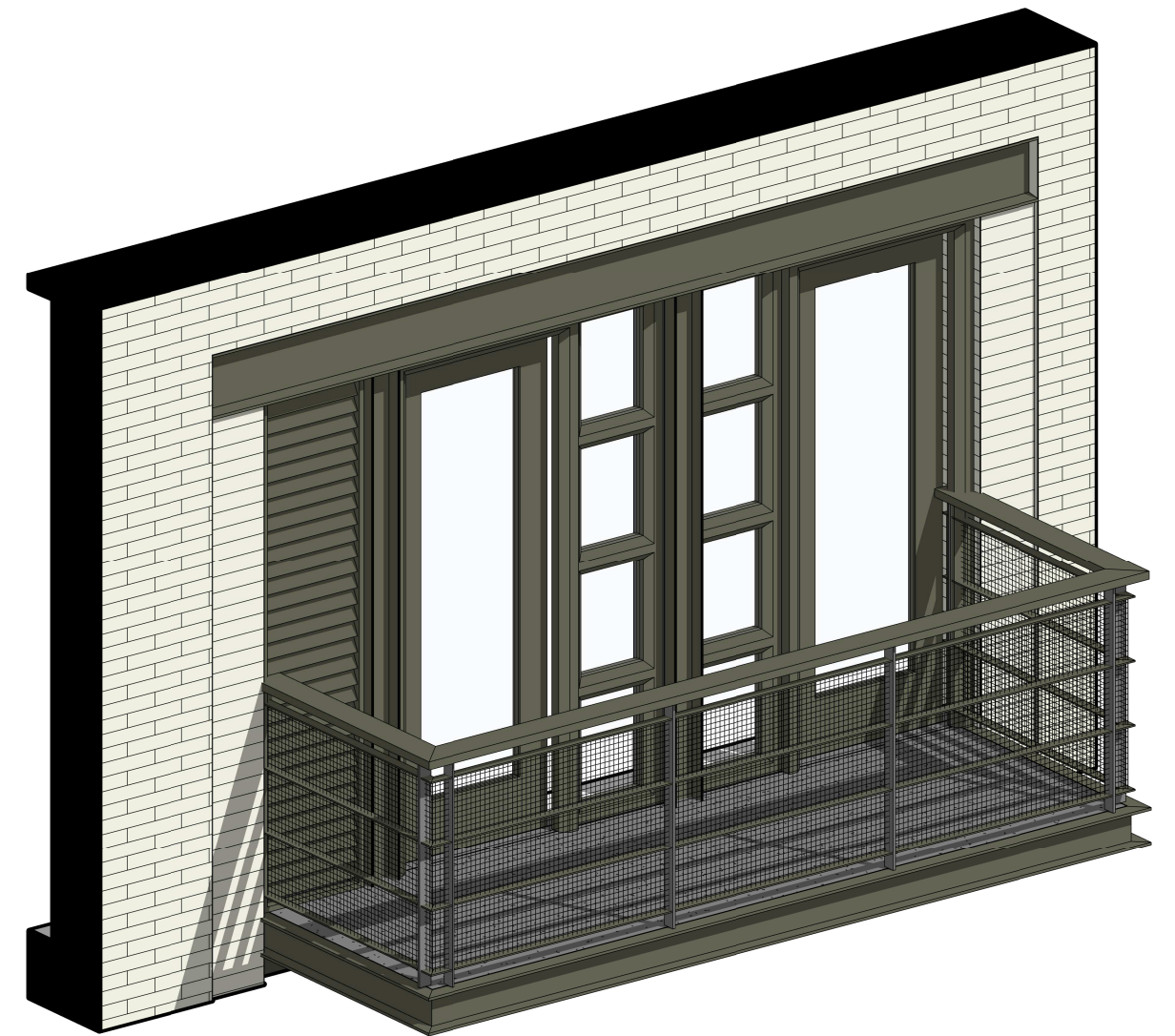
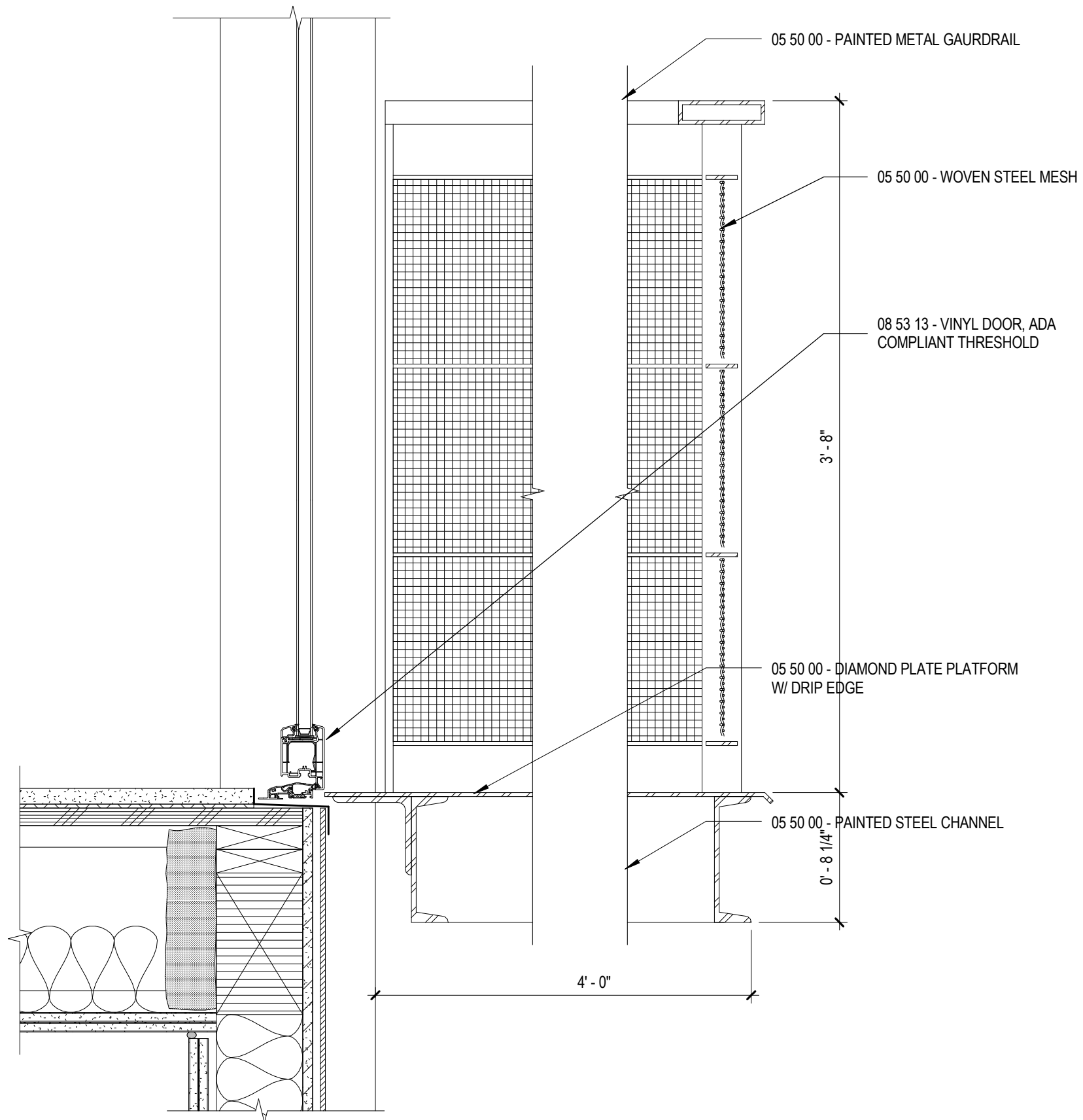

BALCONY SECTION 1

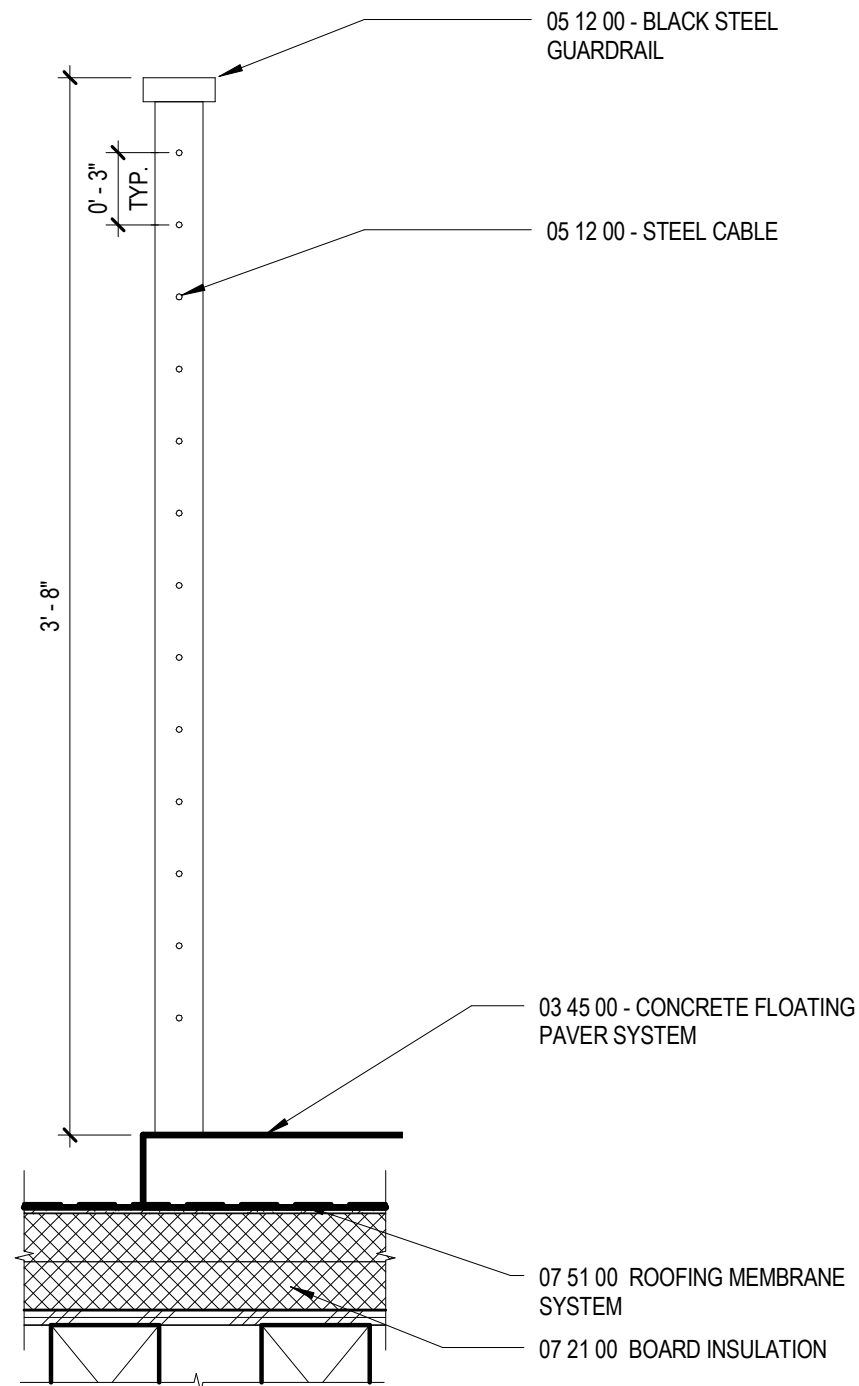

RAILINGS AT ROOF DECK 2

- NOTES:
- 1.) SCREW ATTACH TO HAT CHANNELS 1-1/2" FROM PANEL EDGE AND AT 12" OC ACROSS FACE(ALIGN FASTENERS HORIZONTALLY)
 - 2.) PAINT BACK OF PANELS PRIOR TO INSTALLATION, PAINT FRONT, FASTENERS AND EDGE TRIM FOLLOWING INSTALLATION
 - 3.) PROVIDE 26 GA SHEET METAL 'J' TRIM AT TOP OF ALL PANELS AND 20 GA 'U' CLOSURE AROUND END POST AND CAPTURE PANEL, PAINT TO MATCH PANELS

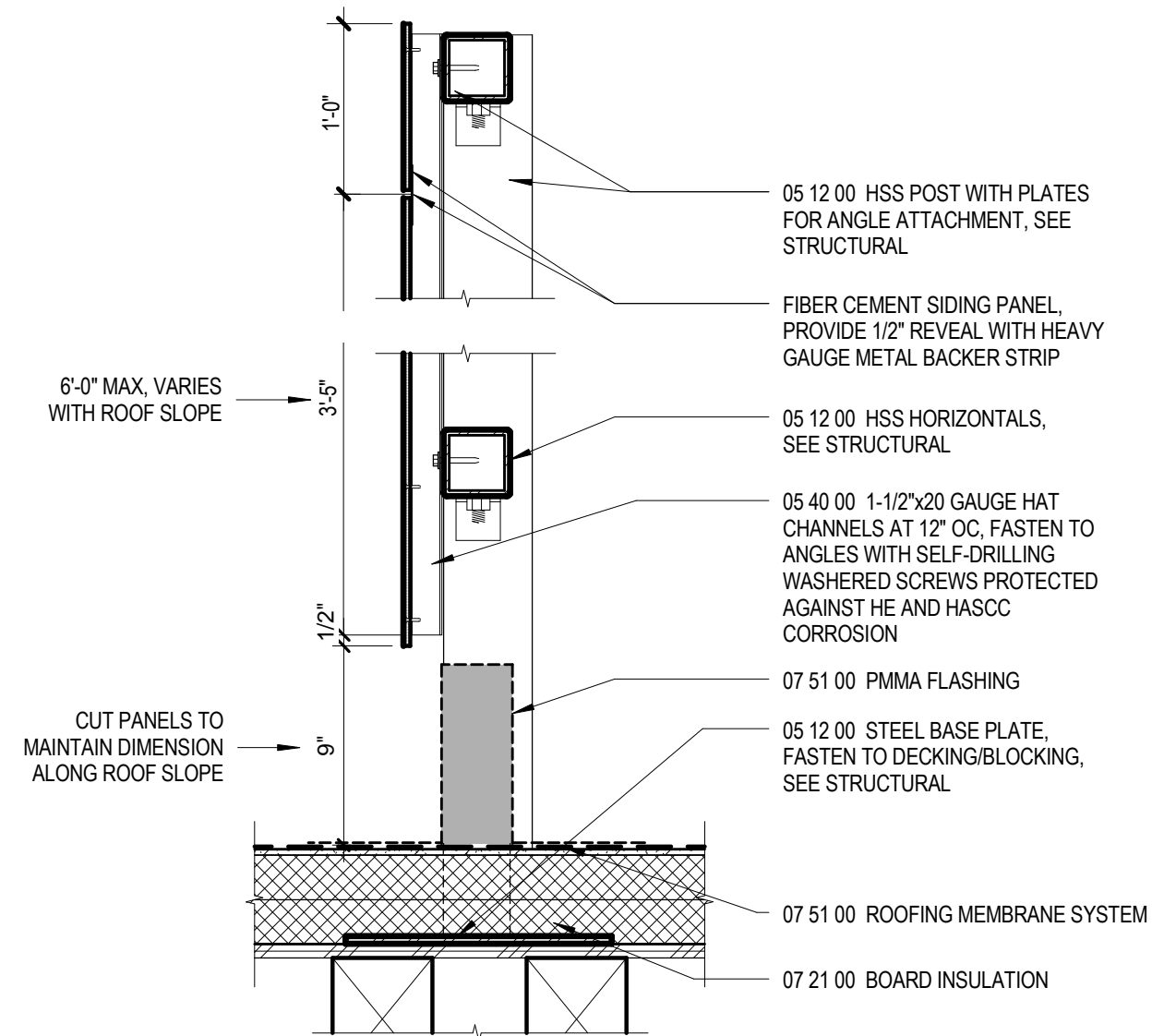

ROOF SCREEN 1