

## Cost of Onsite Parking + Impacts on Affordability

The Bureau of Planning and Sustainability modeled development data to evaluate the cost of providing onsite parking for infill apartments and impacts on affordability. Six different development prototypes were evaluated. A description of methodology used for this evaluation follows.

### Methodology

#### WHAT ARE THE PARKING ALTERNATIVES THAT WERE EVALUATED?

##### Diagram A. Building Prototype Form

No Parking

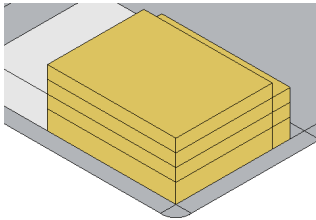

Tuck-Under

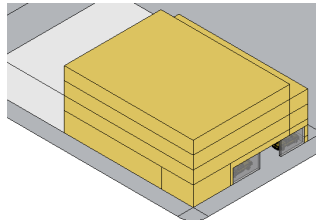

Surface Parking

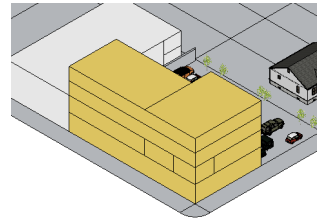

Podium

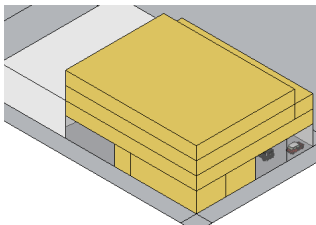

Mechanical

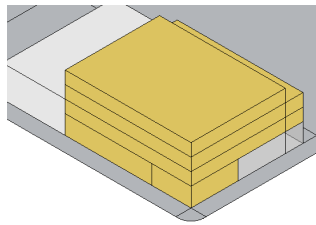

Underground

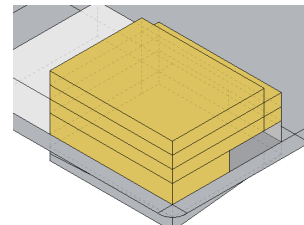

Tuck-

##### Under Parking

Tuck-under parking is distinguished by its open configuration. One wall of the parking area is open with no garage door. Most tuck-under areas have living space or commercial space abutting the rear wall of the parking area.

##### Surface Parking

Surface parking is a parking lot located on street level.

##### Podium Parking

Podium Parking is similar in design to tuck-under parking though will occupy a larger percentage of the ground floor. Podium parking would likely require two curb cuts (in and out) to allow for circulation of vehicles and may have a negative impact to continuous frontage (street-level activity).

### **Mechanical Parking**

Parking lifts are automated or manual lift systems designed to stack one or more vehicles vertically. Parking lifts may be located indoors or outdoors. Where space to provide parking is limited, parking lifts may be an appropriate method for meeting parking requirements. Parking lifts located outdoors must meet applicable height and screening requirements.

### **Underground Parking**

Underground parking is a below ground parking lot that is accessed by a ramped entry. Due to the limited site size for this building prototype, multi-story parking is not considered as the space required for circulation between floors adds significant cost and limits the number of practical spaces per floor. As a result, one level of underground parking is considered.

---

## HOW WERE THE BUILDING PROTOTYPES MODELED?

### **Envision Tomorrow**

Envision Tomorrow puts powerful tools in planners' hands to design and test land use, site development, and transportation decisions. Envision Tomorrow provides planners with an easy-to-use, analytical decision making tool.

The Envision Tomorrow Prototype Builder & Return on Investment (ROI) Model tests the physical and financial feasibility of development. The tool allows for the examination of land use regulations in relation to the current development market and considers the impact of parking, height requirements, construction costs, rents and subsidies. This tool can be used to evaluate what development assumptions will generate a project profit (reported as 7 to 10 profit on investment in this study). In this study, the model was used to assess how alternative parking scenarios and forms of development, such as tuck-under and podium, might become more financially feasible. Similarly, by keeping a standard return on investment rate, a range of monthly rental rates can be modeled to more accurately depict the impact on affordability.

---

## WHAT DEVELOPMENT ASSUMPTIONS WERE USED FOR MODELING?

### **Site Development Assumptions**

All development prototypes assume a 10,000 square foot lot size with 100 foot depth, or 0.23 acres. CS (Storefront Commercial) or Mixed Commercial/Residential (CM) zone is assumed. Both zones intend to promote development that combines commercial and housing uses on a single site. This zone allows increased development potential on busier streets without fostering a strip commercial appearance. Development is intended to consist primarily of businesses on the ground floor with housing on upper stories. Development is intended to be pedestrian-oriented with buildings close to and oriented to the sidewalk, especially at corners.

**Diagram B.** CS/CM Building Envelope Guidelines

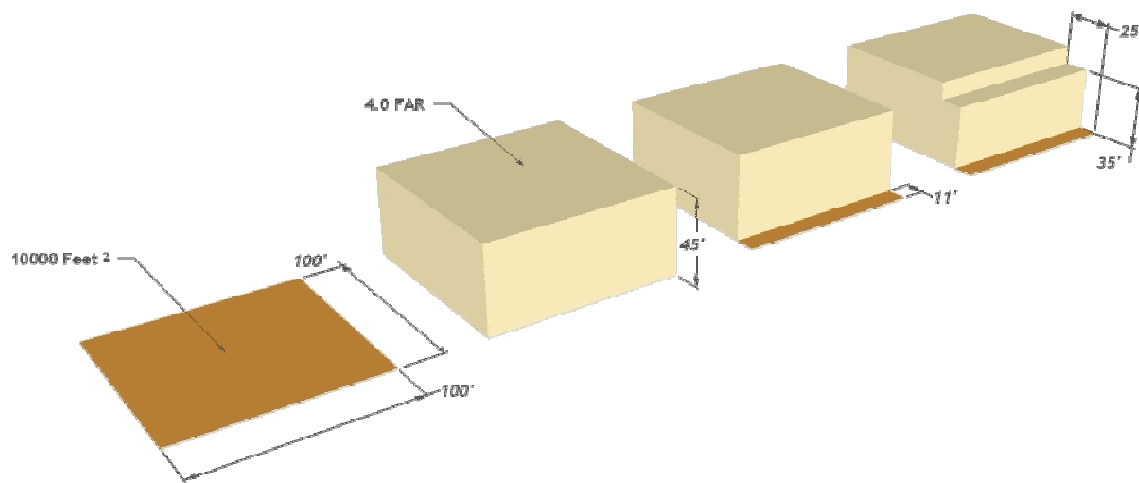

Each development prototype assumes 4 stories of development with an 86% utilization rate. This utilization rate accounts for an eleven foot rear building set back and a maximum height reduction to 35 feet for a 25 foot depth, also at the rear of the building (*see Diagram B*). These reductions amount to an approximate loss of 6,000 square feet buildable area.

As part of the modeling, circulation, lobby, and egress spaces internal to the building are discounted from the gross building square footage. The no parking development prototype assumes 50 units, which translates to an average unit size of 550 square feet after circulation spaces. This unit size remains constant throughout each of the alternative building prototypes.

---

 WHAT DEVELOPMENT COST ASSUMPTIONS WERE USED FOR MODELING?

A site acquisition cost of \$27.00/sq ft was assumed based on a sampling of land values in CS zones in Inner Portland neighborhoods. For a 10,000 sq foot site this translates to \$270,000. Construction costs for residential units were set at \$109.00 a square foot. Given an average unit size of 550 sq feet, this translates to approximately \$60,000 to produce a residential unit. Standard parking spaces are generally assumed to occupy 260 sq feet (including circulation area). Mechanical parking utilizes half this space on account for stacking spaces. In general two standard parking spaces will replace a residential unit. This is important as the main drivers for unit cost are number of units and overall construction cost. As the cost to produce additional parking spaces becomes greater than the cost of the units not produced, rental rates rise. Similarly, as the number of units decreases within a project, project costs are distributed in greater proportion to renters. For example, in the tuck-under development prototype there is an overall cost savings as the 5 units that are not produced (at a cost of \$300,000) come at a greater savings than the cost associated with producing 9 parking spaces (at a cost of \$20,000 a space or total cost of \$180,000). There is a small decrease in the overall project cost; however, as there are 5 fewer units to generate monthly revenue, a slim rental rate increase is observed. In other development scenarios, as the cost to produce parking increases, there is an increase in project cost and a decrease in the total number of units resulting in larger rental rate increases.

**Table A. Cost of Parking**

Parking Type	Parking Costs Per Space
Surface	\$3,000
Podium/Structured (above ground)	\$20,000
Underground	\$55,000
Internal (Tuck Under or Sandwich)	\$20,000
Mechanical	\$45,000

---

 HOW DO THE BUILDING PROTOTYPE ALTERNATIVES PERFORM?

- A building with no parking is able to utilize the full capacity of the development on the site (factoring in assumptions above). In this scenario fifty units and zero parking spaces are constructed. This is the most affordable unit produced amongst the alternatives.
- A building with tuck-under parking is able to utilize nearly all development capacity, with a loss of 5 residential units. In this scenario 45 units and 9 parking spaces are constructed. There is a moderate rental

rate increase associated with this scenario to accommodate the cost associated with providing tuck-under spaces and loss of potential residential units.

- A building with surface parking is able to utilize 50 percent of development capacity. In this scenario 30 units and 19 parking spaces are constructed. There is a rental rate increase associated with this scenario to accommodate for the opportunity cost associated with not producing 20 units.
- A building with podium parking utilizes 75% of the ground floor to provide parking. In this scenario 42 units and 22 parking spaces are constructed. There are negative impacts to ground floor activity and street frontage which may have a direct impact on surrounding businesses, pedestrians, and street character due to additional curb cuts and loss of continuous storefront/first floor character.
- A building with mechanical parking utilizes 40% of the ground floor to provide parking. In this scenario 46 units and 23 parking spaces are constructed. Mechanical parking is a space-efficient parking alternative as it stacks parking spaces with the aid of mechanical systems. As a result, more parking spaces can be constructed in a smaller space; however, it adds significant cost, at \$45,000 a space.
- A building with underground parking is challenged given the limitations of the 10,000 sq foot lot. The practicality of producing underground parking is challenged given the short bay width (less than 100') and limitations to circulation between levels. In this scenario 44 units and 33 parking spaces are constructed. The rental increase can be attributed directly to the cost of providing underground parking at a cost of \$55,000 a space.

**Table B.** Building Prototype Summary

Building Development Prototype	# of Units	# of Parking Spaces	Parking Spaces per Unit	7% ROI* Monthly Rent	10 % ROI* Monthly Rent
No Parking	50	0	0	\$800	\$1150
Tuck-Under	45	9	0.25	\$850	\$1200
Surface	30	19	0.6	\$1200	\$1800
Podium	42	22	0.5	\$950	\$1350
Mechanical	46	23	0.5	\$1175	\$1660
Underground	44	33	0.75	\$1300	\$1900

\*Note: ROI= Return on Investment

Cost of Onsite Parking + Impacts on Affordability

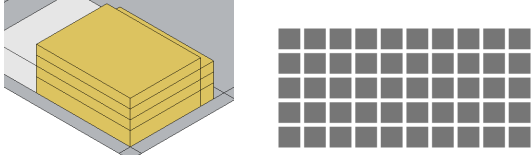
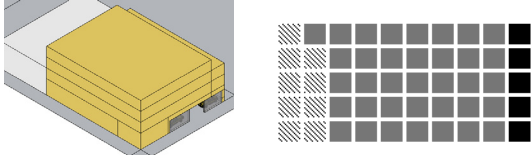
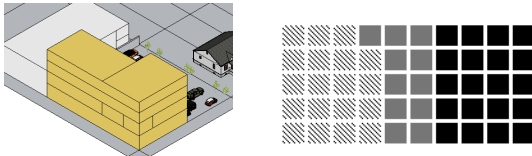
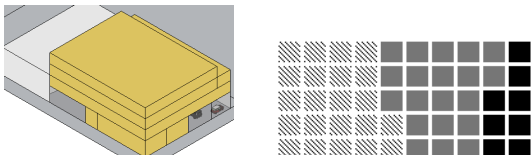
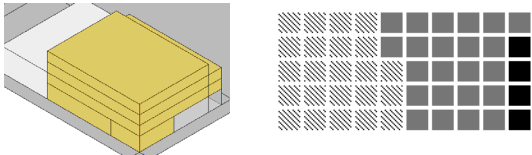
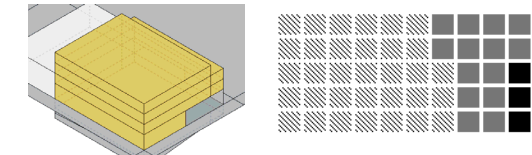
Development Prototype		# of Units	# of Parking Spaces	Parking Spaces per Unit	% of Ground Floor used for parking	Parking Cost as a Percentage of Total Construction Cost	Construction Cost	Potential Monthly Rental Range (550 sq ft apartment)*	Monthly Rent Increase as a percentage above No Parking Development Prototype
<b>No Parking</b>				0	0%	0%	4.3 M	\$800 - \$1,150	-
<b>A</b>		50	0	A building with no parking is able to utilize the full capacity of the development on the site (factoring in assumptions outlined in Methodology). In this scenario fifty units and zero parking spaces are constructed.					
<b>Tuck-Under</b>				0.25	33%	4%	4.3 M	\$850 - \$1,200	6%
<b>B</b>		45	9	A building with tuck-under parking is able to utilize nearly all development capacity, with a loss of 5 residential units. In this scenario 45 units and 9 parking spaces are constructed. There is a moderate rental rate increase associated with this scenario to accommodate the cost associated with providing tuck-under spaces and loss of potential residential units.					
<b>Surface</b>				0.6	47%	2%	2.8 M	\$1,200 - \$1,800	50%
<b>C</b>		30	19	A building with surface parking is able to utilize 50 percent of development capacity. In this scenario 30 units and 19 parking spaces are constructed. There is a rental rate increase associated with this scenario to accommodate for the opportunity cost associated with not producing 20 units.					
<b>Podium</b>				0.5	66%	10%	4.3 M	\$950 - \$1,350	19%
<b>D</b>		42	22	A building with podium parking utilizes 75% of the ground floor to provide parking. In this scenario 42 units and 22 parking spaces are constructed. There are negative impacts to ground floor activity and street frontage which may have a direct impact on surrounding businesses, pedestrians, and street character due to additional curb cuts and loss of continuous storefront/first floor character.					
<b>Mechanical</b>				0.5	40%	22%	5.4 M	\$1,175 - \$1,660	47%
<b>E</b>		46	23	A building with mechanical parking utilizes 40% of the ground floor to provide parking. In this scenario 46 units and 23 parking spaces are constructed. Mechanical parking is a space-efficient parking alternative as it stacks parking spaces with the aid of mechanical systems. As a result, more parking spaces can be constructed in a smaller space; however, it adds significant cost, at \$45,000 a space.					
<b>Underground</b>				0.75	20%	28%	6.5 M	\$1,300 - \$1,900	63%
<b>F</b>		44	33	A building with underground parking is challenged given the limitations of the 10,000 sq foot lot. The practicality of producing underground parking is challenged given the short bay width (less than 100') and limitations to circulation between levels. In this scenario 44 units and 33 parking spaces are constructed. The rental increase can be attributed directly to the cost of providing underground parking at a cost of \$55,000 a space.					

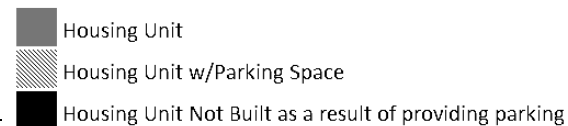

- Based on Results of Envision Tomorrow Return on Investment Model & Analysis.
- Developments with a Return on Investment of 7 to 10% are reported.