

2016



CITY OF PORTLAND Stormwater Management Manual



Stormwater Management Manual

Table of Contents

Chapter 1: Requirements and Policies

1.1 Purpose of the Stormwater Management Manual	1-2
1.1.1 Regulatory Mandates.....	1-2
1.1.2 City Authority	1-4
1.1.3 Relationship to Other Requirements and Standards.....	1-4
1.1.4 Revision and Amendment Process	1-11
1.2 Applicability.....	1-12
1.2.1 Development and Redevelopment.....	1-13
1.2.2 New Connections or Routes of Conveyance.....	1-14
1.2.3 Stormwater Retrofits	1-15
1.2.4 Exemptions.....	1-18
1.3 Stormwater Management Requirements.....	1-21
1.3.1 Infiltration and Discharge Hierarchy.....	1-22
1.3.2 Impervious Area Reduction Techniques.....	1-26
1.3.3 Infiltration Requirements (Categories 1 and 2)	1-26
1.3.4 Stormwater System Requirements (Category 3).....	1-32
1.3.5 Combined Sewer System Requirements (Category 4).....	1-41
1.3.6 Stormwater Master Planning.....	1-43
1.3.7 Summary of Stormwater Management Requirements	1-43
1.4 Operations and Maintenance Requirements	1-46
1.4.1 Exemptions from Operations and Maintenance Requirements.....	1-47
1.4.2 Operations and Maintenance Enforcement	1-47
1.4.3 Revision to Recorded O&M Submittals	1-48
1.5 Special Circumstances.....	1-49
1.5.1 Special Circumstances Submittal Requirements	1-50
<i>Special Circumstances Application Form</i>	1-54
1.6 Administrative Reviews and Appeals.....	1-56

Chapter 2: Stormwater Facility and Conveyance Design

2.1 Site Planning.....	2-4
2.1.1 Design Goals.....	2-4
2.1.2 Steps in the Design Process	2-6
2.2 Sizing Methodologies.....	2-18
2.2.1 Simplified Approach.....	2-21
2.2.2 Presumptive Approach	2-22
2.2.3 Performance Approach.....	2-25
2.3 Stormwater Facility and Conveyance Design	2-29
2.3.1 Types of Stormwater Facilities and Conveyance Features	2-29
2.3.2 Stormwater Facility Configurations	2-30
2.3.3 Standard Landscape Requirements	2-36
2.3.4 Facility and Conveyance Design Criteria.....	2-41
2.3.4.1 Ecoroof.....	2-43
2.3.4.2 Pervious Pavement	2-49
2.3.4.3 Tree Credits.....	2-53
2.3.4.4 Downspout Extension	2-57
2.3.4.5 Rain Garden	2-60
2.3.4.6 Swales	2-64
2.3.4.7 Curb Extension	2-70
2.3.4.8 Planters	2-79
2.3.4.9 Basins	2-85
2.3.4.10 Filter Strips	2-91
2.3.4.11 Grassy Swales.....	2-94
2.3.4.12 Ponds.....	2-99
2.3.4.13 Sand Filters.....	2-109
2.3.4.14 Soakage Trenches	2-112
2.3.4.15 Drywells.....	2-117
2.3.4.16 Sumps.....	2-122
2.3.4.17 Manufactured Stormwater Treatment Technologies.....	2-127
2.3.4.18 Rainwater Harvesting.....	2-129
2.3.4.19 Structural Detention Facilities	2-131
2.3.4.20 Drainageways and Drainage Reserves.....	2-136
2.3.4.21 Drainage Reserve Encroachments	2-140
2.3.4.22 Channel Encroachments	2-143

2.3.5	Typical Details	2-146
	Private Simplified Approach Typical Details (SW-100's).....	2-147
	Private Presumptive and Performance Typical Details (SW-200's)	2-157
	Green Street Typical Details (SW-300's).....	2-175
2.3.6	Infiltration and Soil Requirements.....	2-212
	Depth to Groundwater Investigation.....	2-212
	Infiltration Testing.....	2-218
	Blended Soil Specification for Vegetated Stormwater Systems	2-229
2.4	Submittal Requirements	2-230
2.4.1	Landscape Submittal Requirements	2-230
	<i>Plant List</i>	2-232
	<i>Tree Credit Worksheet</i>	2-243
2.4.2	Land Use Submittal Requirements	2-245
2.4.3	Simplified Approach Submittal Requirements	2-248
	<i>Simplified Approach Form</i>	2-252
2.4.4	Presumptive Approach Submittal Requirements	2-254
2.4.5	Performance Approach Submittal Requirements	2-255
2.4.6	Stormwater Report Submittal Requirements.....	2-257
2.4.7	Drainage Reserve and Encroachment Submittal Requirements ...	2-260
2.4.8	Manufactured Stormwater Treatment Technology Submittal Requirements.....	2-265
	<i>Manufactured Stormwater Treatment Technology Application and Renewal Form</i>	2-273

Chapter 3: Operations and Maintenance

3.1 Operations and Maintenance Requirements for Private Property	3-3
3.1.1 Simplified and Presumptive Approach Maintenance Requirements	3-4
3.1.1.1 Ecoroofs	3-5
3.1.1.2 Pervious Pavement	3-7
3.1.1.3 Trees.....	3-9
3.1.1.4 Downspout Extensions	3-11
3.1.1.5 Rain Gardens.....	3-13
3.1.1.6 Swales	3-15
3.1.1.7 Curb Extensions.....	3-17
3.1.1.8 Planters	3-19
3.1.1.9 Basins	3-21
3.1.1.10 Filter Strips (Vegetated Filters)	3-23
3.1.1.11 Drywells and Soakage Trenches.....	3-25
3.1.2 Performance Approach Maintenance Requirements.....	3-26
3.1.3 Stormwater Conveyance Features.....	3-34
3.1.4 Private O&M Submittal Requirements	3-39
3.2 Operations and Maintenance Requirements for Future Public Facilities ...	3-45
3.4.1 Establishment and Maintenance Requirements	3-46
3.4.2 Manufactured Stormwater Treatment Technologies.....	3-50
3.4.3 Submittal Requirements for Future BES Facilities	3-51

Definitions

Appendix A: Stormwater Design Methodologies

A.1. Santa Barbara Urban Hydrograph Method A-2
A.2. Simplified Approach Sizing Calculations A-10
A.3. Stormwater Pollution Reduction Storm A-14
A.4. Presumptive Approach Calculator Technical Framework A-23

Appendix B: Culverts and Outfalls

B.1. Culverts and Other Water Crossing Structures B-2
B.2. Outfalls B-14
B.3. Reference Material B-24

Appendix C: Resources and References

C.1. Stormwater Management Manual Contact Information C-2
C.2. Permitting and Development Review C-2
C.3. City Codes C-3
C.4. City of Portland Resources C-4
C.5. Site Evaluation Maps C-6
C.6. Additional Resources C-7

Chapter 1. Requirements and Policies

This chapter establishes the City of Portland’s stormwater management requirements. It includes the following sections:

- 1.1 Purpose of the *Stormwater Management Manual*..... 1-2
 - 1.1.1 Regulatory Mandates..... 1-2
 - 1.1.2 City Authority 1-4
 - 1.1.3 Relationship to Other Requirements and Standards..... 1-4
 - 1.1.4 Revision and Amendment Process 1-11
- 1.2 Applicability..... 1-12
 - 1.2.1 Development and Redevelopment..... 1-13
 - 1.2.2 New Connections or Routes of Conveyance..... 1-14
 - 1.2.3 Stormwater Retrofits 1-15
 - 1.2.4 Exemptions..... 1-18
- 1.3 Stormwater Management Requirements..... 1-21
 - 1.3.1 Infiltration and Discharge Hierarchy..... 1-22
 - 1.3.2 Impervious Area Reduction Techniques 1-26
 - 1.3.3 Infiltration Requirements (Categories 1 and 2) 1-26
 - 1.3.4 Stormwater System Requirements (Category 3)..... 1-32
 - 1.3.5 Combined Sewer System Requirements (Category 4)..... 1-41
 - 1.3.6 Stormwater Master Planning..... 1-43
 - 1.3.7 Summary of Stormwater Management Requirements 1-43
- 1.4 Operations and Maintenance Requirements 1-46
 - 1.4.1 Exemptions from O&M Submittal Requirements..... 1-47
 - 1.4.2 Operations and Maintenance Enforcement 1-47
 - 1.4.3 Revisions to Recorded O&M Submittals..... 1-48
- 1.5 Special Circumstances..... 1-49
 - 1.5.1 Special Circumstances Submittal Requirements 1-50
- 1.6 Administrative Reviews and Appeals..... 1-56

1.1 Purpose of the *Stormwater Management Manual*

As the City of Portland is developed, impervious surfaces create increased amounts of stormwater runoff during rainfall events, modifying drainage patterns and flows and disrupting the natural hydrologic cycle. Without stormwater management, these conditions erode stream channels and prevent groundwater recharge. Parking lots, roadways, rooftops, and other impervious surfaces increase the pollution levels and temperature of stormwater transported to streams, rivers, and groundwater resources. Implementing the requirements in this manual helps protect Portland's water resources, which in turn will provide great benefit to human health, fish and wildlife habitat, recreational resources, and drinking water.

Stormwater management is also critical in terms of protecting Portland's sanitary and stormwater infrastructure. Increased runoff contributes to combined sewer overflows (CSOs), basement sewer backups, and localized flooding. Implementing onsite infiltration and flow control measures will conserve the existing and future conveyance capacity of storm sewers, drainageways, and combined sewers.

Strategies for meeting the requirements in this manual depend on a number of site factors, including infiltration and system capacity, available infrastructure, proposed development plans, and the storm system or drainage basin the proposed development is in. The standards addressed in this manual are intended to make site-specific improvements across the City and to comprehensively manage stormwater by watershed.

Stormwater management is critical to maintaining and enhancing the City's livability and improving watershed health. The *Stormwater Management Manual (SWMM)* allows the City of Portland to protect both watershed resources and infrastructure investments with every development or improvement. As each project meets the requirements of this manual, it will contribute to achieving these important citywide goals.

1.1.1 Regulatory Mandates

In response to the impacts of urbanization on water quality, Congress passed the Clean Water Act of 1972 (amended in 1987), which prohibits the discharge of pollutants into waters of the United States unless the discharge is in compliance with a National Pollutant Discharge Elimination System (NPDES) permit. Portland has two types of NPDES permits under the Clean Water Act: a stormwater permit and wastewater treatment plant permit that includes the combined sewer collection

system. The NPDES stormwater permit requirements, published in 1990, require large (Phase I) cities such as Portland to obtain an NPDES stormwater permit for their municipal separate storm sewer system (MS4) discharges. Portland's MS4 system includes conveyance or systems of conveyances such as municipal streets, catch basins, curbs, gutters, ditches, manmade channels, or storm sewers owned by the City of Portland designed or used for collection or conveyance of stormwater. The Oregon Department of Environmental Quality (DEQ) issued Portland's first MS4 permit in 1995. Portland City Council directed the Bureau of Environmental Services (BES) to lead the citywide response for stormwater requirements and implementing key program elements.

Compliance with the NPDES MS4 permit requires cities to establish a comprehensive stormwater management program, including establishing controls on post-development stormwater runoff. Portland adopted its first citywide *Stormwater Management Manual (SWMM)* in 1999, which includes water quality and flow control design standards for onsite stormwater management facilities. The SWMM focuses on low-impact development practices, stormwater management facilities and conveyance features, and maintenance and operational best management practices (BMPs) designed to improve stormwater quality. This SWMM is part of Portland's NPDES MS4 stormwater management program to improve the quality of Portland's waters.

With the completion of the City's Combined Sewer Overflow Program in 2011, the management of the combined sewer system is primarily guided by two requirements: the City's NPDES discharge permit for the Columbia Boulevard Wastewater Treatment Plant and the EPA's CSO Policy. The City's NPDES wastewater discharge permit includes requirements for Capacity, Management, Operation and Maintenance (CMOM). The EPA's CSO Policy includes Nine Minimum Controls for treatment of wet weather overflow events. Both CMOM and the Nine Minimum Controls rely on reducing stormwater discharges to the combined sewer. The SWMM requirements help reduce the need for storage in the combined sewer collection system through stormwater volume reduction and flow control requirements. This SWMM is part of Portland's combined sewer program by reducing and controlling the amount of stormwater that discharges to the combined sewer.

In addition, the federal Safe Drinking Water Act (SDWA) of 1974 provides a comprehensive framework to ensure the quality and safety of drinking water supplies. Within the state of Oregon, the Department of Environmental Quality regulates stormwater discharges to underground injection control (UIC) systems

under the SDWA. UICs, such as drywells, sumps, or soakage trenches, are used to infiltrate stormwater runoff from structures, streets and other impervious surfaces. DEQ issued a water pollution control facility (WPCF) permit to the City in 2005 for approximately 9,000 public UICs used to manage stormwater runoff from the public right-of-way. As part of permit compliance, the City was required to establish a comprehensive UIC management plan that includes structural, nonstructural, and institutional controls to ensure the protection of groundwater as a drinking water resource. This SWMM assists with the implementation of Portland's UIC management plan. BES is the lead agency responding to the citywide WPCF permit.

The purpose of this manual is to respond to these regulatory mandates by providing stormwater management principles and techniques that help preserve or mimic the natural hydrologic cycle, minimize sewer system problems, and improve water quality. The manual provides developers and design professionals with specific requirements for reducing the impacts of stormwater from new development and redevelopment.

1.1.2 City Authority

The SWMM is part of BES's Administrative Rules, authorized by [Portland City Code Chapter 17.38](#). The SWMM is adopted by the Director of BES following a public review process, and filed with the City Auditor as required [by Portland City Code Chapter 1.07](#). In 1999, City Council adopted code changes to Portland City Code 17.38 to authorize the Director of Environmental Services to adopt rules, procedures, and forms and to maintain a SWMM ([Ordinance #173330](#)). In 2000, in conjunction with a City Code update, City Council confirmed the authority of the Director of BES to update the SWMM ([Ordinance #174745](#)).

1.1.3 Relationship to Other Requirements and Standards

A number of other City technical standards, design guidelines, and policies may impact the selection, placement, and design of stormwater facilities, conveyance features, and related infrastructure. The location and scope of the proposed development or improvement or the status of existing infrastructure may also trigger additional requirements. Before finalizing any design, it is the responsibility of the project designer to resolve potential conflicts. A number of state or federal requirements may also apply depending on size, scope, and impacts to waterways.

Sewer and Drainage Facilities Design Manual

Both the SWMM and the [Sewer and Drainage Facilities Design Manual](#) (SDFDM) are under the authority of the Bureau of Environmental Services (BES) and have been

adopted by City Council as administrative rules. They are complimentary documents that share standards related to the hydrology and hydraulic design of public drainage facilities.

The SWMM is the primary reference for designing public and private stormwater management facilities. Private development, redevelopment, or stormwater retrofits, public works projects, and capital improvement projects that trigger stormwater management requirements must use the SWMM to design stormwater management facilities and stormwater conveyance facilities.

The SDFDM is the primary reference for designing public sewers and drainage facilities. The SDFDM applies to all public sanitary, stormwater/drainage and combined sewers owned by the City and privately owned facilities located in public rights-of-way or in public easements.

Table 1-1 provides some common examples of when one or both manuals may be required. Both manuals provide design requirements for culverts, outfalls, ditches/road shoulder improvements and drainageways or open channels.

Table 1-1. Relationship between the SWMM and the SDFDM

Design Requirements by Project Scope	SWMM	SDFDM
Public sanitary, combined, or storm-only sewers		X
Public stormwater management facilities with no overflow conveyance to public combined or storm-only sewers (e.g., sumps)	X	
Public stormwater management facilities with overflow conveyance to public combined or storm-only sewers or drainage facilities	X	X
Private stormwater management facilities with no conveyance to an offsite storm system	X	
Private stormwater management facilities with offsite conveyance to a public combined or storm-only sewer	X	X

The content of the two manuals may overlap while addressing different aspects of stormwater system design. Designers must reference both manuals when working in the City of Portland to determine the appropriate standards that apply to a project.

Source Control Manual

Both the SWMM and the [Source Control Manual](#) are under the authority of the Bureau of Environmental Services. The *Source Control Manual*, previously Chapter 4

of the 2014 SWMM, is a separate manual and is authorized by Portland City Code 17.38.035 B.2, 17.38.035 D, and 17.38.035 F and will be adopted as an administrative rule concurrently with the adoption of the 2016 SWMM.

Some site characteristics, activities, and uses on property (either publicly or privately owned) may generate or mobilize specific pollutants of concern or levels of pollution that are not addressed solely through implementation of the SWMM. The *Source Control Manual* defines these site characteristics, activities and uses and identifies best management practices and structural source controls that must be implemented to manage pollutants at their source. Any project of any size that exhibits, has or introduces these site characteristics, activities and uses must comply with the *Source Control Manual*. This includes new development, redevelopment, tenant improvements, changes to site uses or activities, and changes to specific site or activity areas, even if no impervious area is added or replaced.

The content of the two manuals may overlap while addressing different aspects of stormwater management. A project may be required to meet the requirements of both manuals. For example, a site with known contamination of soil or groundwater may be limited to certain stormwater facility configurations in order to reduce risk of mobilization. Before finalizing any design, it is the responsibility of the project designer to contact the City to resolve potential conflicts between the two manuals.

Public Works Improvements

The Portland Bureau of Transportation (PBOT) has broad code authority over public improvements in the public right-of-way under Title 17 and Title 33 of Portland City Code. Street improvements required as a condition of development will often trigger SWMM requirements. Street and stormwater improvements in the public right-of-way required as a condition of approval are most often constructed under a Public Works Permit. Work in the public right-of-way has applicable design standards and construction requirements. Projects going through the Public Works Permit process will have opportunities during concept design review to identify and resolve any conflicting requirements with City staff.

Title 10 (Erosion and Sediment Control Regulations)

Erosion of soils and sediments has negative impacts on public health, private property, waterways and stormwater systems, and public infrastructure. Title 10 of Portland City Code requires development and construction activities to reduce erosion and control sediment during and following construction, including all ground-disturbing activities. Erosion control is a requirement of the City's MS4 permit as a mechanism to reduce pollutants in stormwater runoff. The Bureau of Development Services (BDS) enforces temporary and permanent erosion control

measures for development and construction projects on private property during the development review and construction inspection processes. Individual infrastructure bureaus manage their own erosion control activities for construction in the public right-of-way, in a public easement, or under a Public Works Permit or contract. Technical guidance for meeting the erosion control requirements of Title 10 is found in the [Erosion Control Manual](#).

Additionally, implementing erosion control practices can help protect constructed or existing stormwater management facilities and conveyance features from sedimentation, thereby reducing the amount of annual maintenance needed to preserve required functionality.

Title 11 (Trees)

Tree preservation and planting requirements are found in Title 11 of Portland City Code. Title 11 is implemented by the Bureau of Development Services for trees in development situations and by the Portland Parks and Recreation and the City Forester for trees on private property, City trees, and street trees not in development situations. Title 11 may apply to existing and new trees on private property, street trees (in landscape or parking strips), and other trees in the public right-of-way.

Vegetated facilities integrated into project landscape areas may be able to meet many Title 11 tree requirements. Trees required by Title 11 may be counted towards meeting the facility-specific landscape requirements of the SWMM. Similarly, trees that meet the requirements of this SWMM may also meet Title 11 requirements.

Title 21 (Water)

To protect groundwater as a source of drinking water for the region, the Portland Water Bureau regulates the storage, handling, use, and transportation of hazardous materials in the Columbia South Shore Well Field Wellhead Protection Area (see Figure 1-1). Requirements focus on spill control measures and preventing pollutants from entering into groundwater. The full regulations are contained in the [Columbia South Shore Well Field Wellhead Protection Manual](#) and apply to indoor and outdoor storage areas; loading and unloading areas; fuel dispensing facilities; storage maintenance and repair of vehicles and equipment; and transportation routes on private property and in public rights-of-way. Portland Water Bureau review is required to verify compliance with the wellhead protection regulations.

Public and private stormwater facilities in the Columbia South Shore Well Field Wellhead Protection Area that receive runoff from commercial areas or highly

travelled residential roadways must be equipped with impervious spill control features. Specifications and requirements are found in the [Wellhead Protection Area Reference Manual](#) and the [City of Portland Standard Construction Specifications](#).

Figure 1-1. Columbia South Shore Well Field Wellhead Protection Area

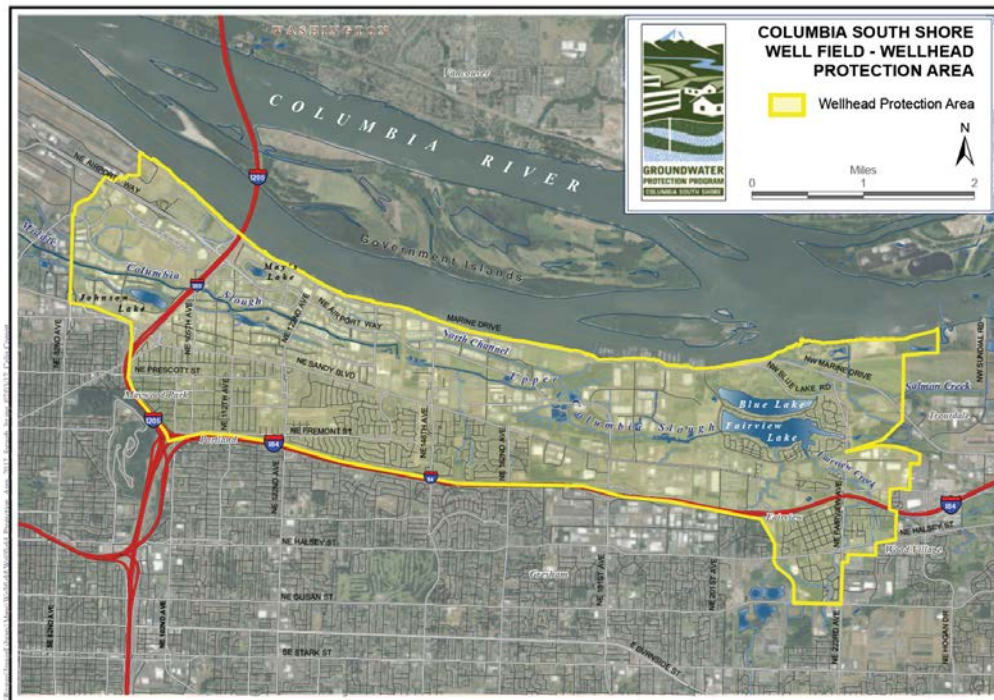

Current as of 2016; official boundaries maintained by the Portland Water Bureau.

Titles 24 and 25 (Building and Plumbing Regulations)

State building and plumbing code requirements are implemented through the Bureau of Development Services during the development review process for private property. BDS approves private parking and driveway surfaces (see Portland City Code 24.45), flood hazard areas (see Portland City Code 24.50), and installation of private downspouts, pipes and sewers, including those that lead to or from stormwater management facilities.

Title 33 (Planning and Zoning)

Planning and Zoning requirements are implemented by the Bureau of Development Services during the development review process. Zoning codes may require a specific type of stormwater management facility, specify landscape requirements or protection of environmental features, or provide incentives or options for incorporating stormwater management facilities to meet Title 33 requirements of Portland City Code. The below sections describe only some of the relevant Planning

and Zoning requirements that may impact stormwater management facility and conveyance feature selection, siting, and design. Code requirements such as minimum density, minimum lot coverage, and required zero-lot-line setbacks for urban districts may exempt the use of onsite infiltration facilities. Even if space constraints prohibit the construction of onsite infiltration facilities, stormwater management requirements for the site must still be met. Project designers should coordinate with BDS and research the specific zoning codes, overlays, and other Planning and Zoning requirements that would apply to their site.

Ecoroof Requirements and Floor Area Ratio Bonuses.

Where provisions in Title 33 require a new development or redevelopment project to include an ecoroof or award bonus floor area or height due to the inclusion of an ecoroof, the ecoroof must meet all of the technical design and maintenance standards detailed in Chapters 2 and 3 of the SWMM, as approved by BES. Title 33 will specify when these provisions are triggered and the specific percent ecoroof coverage standards that must be met.

Landscaping.

When vegetated stormwater management facilities are integrated into landscape areas, they can meet many, if not all, of the Title 33 landscape requirements. The benefits of integrated design include construction cost savings, combined maintenance, aesthetic benefits, and the greater likelihood of maintaining long-term functionality. Well-designed and established landscaping will also prevent post-construction soil erosion. Where the requirements of the SWMM and Title 33 differ, both requirements must be met. For example, when plant material requirements vary, the larger quantities and sizes must be used (fractions should be rounded to the highest whole number). Landscaping required by Title 33 may be counted toward meeting the facility-specific landscape requirements of Chapter 2 of the SWMM if the plantings are located within the facility area. Similarly, plantings that meet the requirements of Chapter 2 of the SWMM may also meet Title 33 landscape requirements.

Non-Conforming Parking Lots.

Development and redevelopment projects must meet Title 33 parking requirements and development standards for parking and loading (see Portland City Code 33.266). Chapter 258 (Nonconforming Situations) of Title 33 requires nonconforming parking, drive, and maneuvering areas to be brought into compliance with current landscaping requirements under certain conditions (see Portland City Code

33.258.070). Many nonconforming parking lots lack stormwater facilities or vegetation. As parking lots are redesigned to be in conformance with current requirements, stormwater management must be incorporated if feasible. Feasibility is determined by a number of factors, including, but not limited to:

- Existing grades must allow stormwater to flow towards the newly vegetated areas and vegetated facilities.
- Soil conditions must be evaluated to determine if infiltration is feasible at the proposed location. Infiltration feasibility may include infiltration rate or presence of soil or groundwater contamination.
- Infiltration setbacks must be considered in relationship to property lines and adjacent structures. If perimeter landscaping abuts the property line, standard setback requirements and the location of existing development on abutting or downhill parcels may determine feasibility of infiltration.

City of Portland Green Building Policy

Construction of new City buildings must meet the City's Green Building Policy requirements for stormwater management. Complete criteria and applicability for Portland's green building policy are described in [Policy Document ENB-9.01](#).

Port of Portland Stormwater Design Standards Manual

As of January 1, 2014, the Port of Portland adopted a Stormwater Design Standards Manual (DSM) in accordance with the requirements of Municipal Separate Storm Sewer System (MS4) permit number 101314 issued by the Oregon Department of Environmental Quality. Within the City of Portland, the SWMM and the DSM may both apply. Projects on Port-owned property within the City of Portland require coordination with both Port and City staff to determine what stormwater standards may be applicable (see [Section 1.2.4](#) for DSM-specific exemptions to the SWMM). In addition, the Port of Portland has requirements that are specific to airport operations, such as wildlife management related to aviation safety requirements. For example, a vegetated stormwater management facility may be required to meet stormwater management requirements of the SWMM, but plant selection within the facility may need to meet Port of Portland requirements.

The DSM does not incorporate all of the regulatory requirements that are potentially applicable to a project and thus does not eliminate the need to comply with other applicable local, state, and federal regulatory requirements, including City codes, plan districts (such as Portland City Code 33.565.560 Portland International Airport Plan District) and ordinances that are outside the scope of the DSM or the SWMM.

Projects will still need City permits for land use, public works, building or other development-related permit approval.

Projects subject to the DSM are required to obtain Port approval of the stormwater management design prior to BES approval of building plans and building permit issuance. Projects required to use the DSM to meet stormwater management requirements will be issued a Service Agreement Letter from the Port of Portland that confirms DSM applicability.

1.1.4 Revision and Amendment Process

The SWMM is reviewed and updated as necessary. The review process includes:

- Consideration of new or pending regulatory requirements.
- Consideration of updated and new technologies.
- Review of appeals made during the preceding interval.
- Review of approved performance-based approaches.
- Review of community comments and concerns, including those of advisory bodies and professional organizations.
- Review of other City design or review processes and permit submittal requirements for consistency with City Code and Administrative Rules.

The amendment process will also include a public comment period to review amendments as identified in Portland City Code 3.13 and will produce documentation and explanation of any changes made.

Suggestions for changes and improvements can be made at any time and should be emailed to BESStormManual@portlandoregon.gov or sent to:

City of Portland, BES
1120 SW 5th Ave., Room 1000
Portland, OR 97204
Attention: SWMM Manager

1.2 Applicability

All proposals related to development, redevelopment, new connections or new offsite stormwater disposal locations are subject to the requirements of the SWMM, unless specifically exempt ([Section 1.2.4](#)). Modifying connections, conveyance, route of conveyance (such as disposal location), or alterations and encroachments near drainageways may also initiate stormwater management requirements. Stormwater management requirements apply to projects on both private and public property or right-of-way with existing or new impervious area, including, but not limited to, all roofs, patios, walkways, parking lots, streets, alleys, driveways, and sidewalks. Stormwater management requirements include drainage and conveyance of stormwater in a manner that protects and improves water quality.

The City implements stormwater management requirements during a number of project design, review and/or permit processes. The permit processes generally include land use reviews and other reviews under Planning and Zoning code, site improvements (zoning, site development, or development review), building permits, and Public Works Permits. Each development proposal has a unique set of reviews and permits, based on what is proposed and the site conditions (e.g., location, topography, zoning, infiltration rates). Internal design and review processes may happen during design of system improvements, interagency review of public improvements, or other capital projects or public improvements.

Stormwater that is generated from impervious area on property must be managed on the same property in facilities maintained by the property owner, whether publicly or privately owned. Stormwater that is generated within the public right-of-way must be managed in the public right-of-way in publicly maintained facilities.

Stormwater facilities required as a condition of development or redevelopment in the right-of-way must be sized to manage stormwater from the contributing impervious area within the right-of-way, including sidewalks and driveway aprons. Stormwater facilities in the right-of-way are not sized to treat stormwater from private driveways, which must be managed on private property. Site-specific stormwater management requirements are identified in [Section 1.3](#) and stormwater facility design and configuration is discussed in [Chapter 2](#).

The Bureau of Development Services administers the development review process, including land use reviews as well as building and trade permits for private improvements. BES reviews, approves, and inspects stormwater facilities on private property within the development permitting process. Public Works Permits are

required for public infrastructure improvements, which are generally located in the public right-of-way and are administered by the City's service bureaus, including Transportation, Environmental Services, and Water.

Development-initiated stormwater improvements

For more information about the City of Portland's development review and permit processes, refer to <http://www.portlandoregon.gov/bds>.

For more information about the City of Portland's Public Works Permit process, refer to <http://www.portlandoregon.gov/publicworks>.

1.2.1 Development and Redevelopment

Projects that develop or redevelop over 500 square feet of impervious surface are required to comply with stormwater management requirements for the new or redeveloped impervious area at the site, unless specifically exempt (see [Section 1.2.4](#)).

Development is defined as any human-induced change to improved or unimproved real estate, whether public or private, including, but not limited to, construction, installation, or expansion of a building or other structure; land division; street construction; drilling; and site alteration such as dredging, grading, paving, excavation, filling or clearing. Development includes both new development and redevelopment.

Development includes creation of new impervious area, expanding the footprint of existing structures or impervious area, or expansion of existing or new structures within the existing development footprint. This would include modifications, alterations, or additions to an existing structure that add 500 or more square feet of impervious area within the existing development footprint even if the development proposal does not affect the ground floor footprint. This includes, but is not limited to, enclosing existing impervious area or adding additional floors to an existing building.

Redevelopment is defined as any development that includes demolition or removal of existing structures or impervious surfaces at a site and replacement with new impervious surfaces. This would include partial demolitions or alterations that rebuild within the same development footprint. This would also include repaving paved or other impervious surfaces that exposes gravels, aggregates or soils (see [Figure 1-2. Paved Impervious Surface Cross Section](#)).

Figure 1-2. Paved Impervious Surface Cross Section

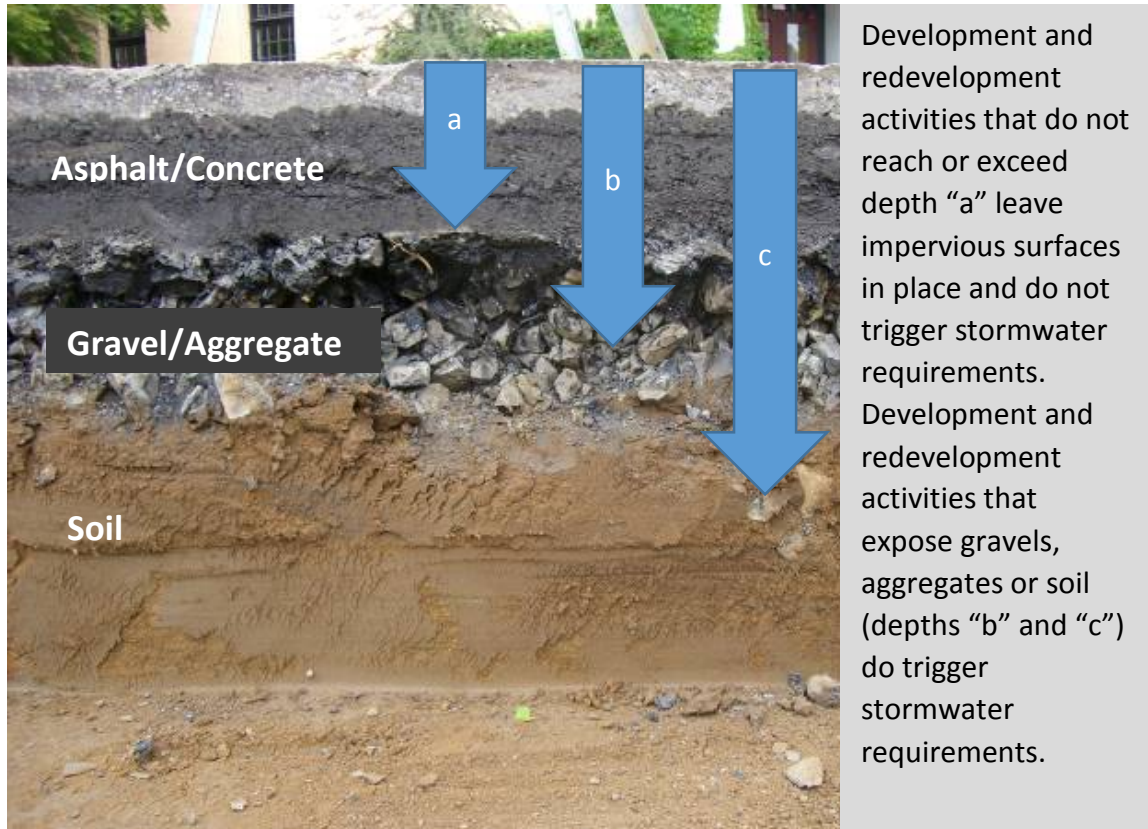

Photo: City of Portland.

1.2.2 New Connections or Routes of Conveyance

Projects that propose new offsite discharges or new connections to the public system are required to comply with stormwater requirements for the impervious area draining to the offsite discharge location, unless specifically exempt (see [Section 1.2.4](#)). This includes, but is not limited to:

- New connections or new drainage areas routed into the City’s sewer or drainage system under a City permit or from a public improvement.
- Changing the disposal location of an existing drainage area to a different disposal location or storm system. A different disposal location would include directing stormwater to a different drainage or waterbody.

The following are examples of new discharge locations or new connections:

- Decommissioning private drainage or infiltration systems and discharging offsite to a storm sewer or other storm system.
- Disconnecting from one public sewer system and connecting to a different type of sewer system, such as changing from a City storm sewer to a City combined sewer.
- Changing the disposal point of stormwater runoff in the right-of-way, such as decommissioning an existing sump and routing that stormwater to a storm-only sewer.

1.2.3 Stormwater Retrofits

A stormwater retrofit is the installation of a new stormwater facility to treat stormwater from existing impervious area.

Stormwater retrofits may not be required by the development ([Section 1.2.1](#)) or new connection requirements ([Section 1.2.2](#)). Stormwater retrofits may be triggered by other development proposal requirements or improvements projects and are installed for a variety of reasons, including:

- Land use, building, zoning, public works or other City development proposals that may trigger compliance with SWMM requirements.
- DEQ requirements for meeting discharge limits or other compliance requirements.
- Property owners motivated to increase their private stormwater management to provide multiple watershed health benefits, including reducing stormwater flow to combined sewer systems, resolving private drainage issues, providing groundwater recharge and reducing ecological footprints.
- Ratepayers wanting to reduce stormwater utility charges.
- Targeted public system improvements that provide sewer capacity, water quality or other environmental benefits as per adopted City system or facilities plans.

Each retrofit project has specific conditions unique to that site. These conditions include location of existing structures and other impervious areas, zoning considerations, soils, slopes, current and historic site use, source controls, potential contamination, required uses (e.g., number of parking spaces, accessibility), desired uses (e.g., play or other common areas, gardens, visual amenities), and the existing stormwater discharge location.

There are two types of stormwater management retrofits: City-required stormwater retrofits and owner-initiated stormwater retrofits. Both types of retrofits may be triggered by a regulatory requirement, but the difference in SWMM applicability is due to who initiated the decision or obligation to retrofit. City-required stormwater retrofits are those required by the City of Portland. Owner-initiated retrofits are those initiated by a property owner or public agency to meet other regulatory or system needs. Regardless of type of retrofit, type and sequencing of any required permits or reviews are determined by site use and stormwater facility characteristics.

City-Required Stormwater Retrofits

City-required stormwater retrofits result from a City review against City approval criteria, City code or rules; from a City enforcement action; or system plan requirement. City-required stormwater retrofits help the City control stormwater discharges by requiring the site to comply with the SWMM as a condition of development or as a result from an enforcement action. City-required stormwater retrofits, such as those required by a land use, zoning, building permit, public improvement, other conditions of development, or enforcement action must meet the SWMM requirements in full.

Owner-Initiated Stormwater Retrofits

Owner-initiated stormwater retrofits result from property owners or public agencies increasing stormwater management. This may also include retrofits required by non-City imposed water quality requirements (e.g. DEQ Tier 2 requirements), such as individual discharge permits, source controls, or clean up actions.

Owner-initiated stormwater retrofits must meet the following SWMM requirements:

- Facility design and landscaping, facility sizing methodology, and any appropriate permit submittals for appropriately selected and sized stormwater facilities as required in [Chapter 2](#).
- Operations and maintenance requirements, as established in [Section 1.4](#) and [Chapter 3](#).

For owner-initiated stormwater retrofits, there is flexibility in the facility sizing and in meeting the stormwater infiltration and discharge hierarchy. The City would rather encourage stormwater retrofits where the facilities meet some portion of the required SWMM sizing requirements than disallow facilities that do not meet full sizing criteria. These smaller facilities can still collectively add up to significant management of runoff from existing impervious surfaces. The following facility sizing and discharge criteria apply:

- Owner-initiated retrofits on property (privately or publicly owned) are encouraged to size facilities through the Simplified Approach for project areas of less than 10,000 square feet. If site characteristics make Simplified Approach sizing difficult to achieve, stormwater retrofits may use the Presumptive Approach to size smaller facilities to meet the water quality design storm.
- Owner-initiated stormwater retrofits are encouraged to meet the stormwater hierarchy by fully infiltrating whenever feasible. Infiltration testing (as specified in [Section 2.3.6](#)) is required for certain sizing approaches or stormwater facility options. If total infiltration is not feasible, stormwater retrofits are allowed to use existing discharge systems and do not need to meet the stormwater hierarchy for discharge criteria. At sites where the Simplified sizing approach is appropriate and possible and total infiltration is not expected to be feasible, infiltration testing is not required, and the site can use the existing discharge location. Examples of existing discharge locations include, but are not limited to, catch basins connected to offsite public systems or existing infiltration facilities.
- Applicants submitting stormwater retrofits as part of a development proposal should clearly note on project submittals and any permit applications that the project is an owner-initiated stormwater retrofit, what design storm sizing was used to size facilities, what existing discharge location is used, and how and where the proposed stormwater management facility will connect to the existing discharge location.
- Owner-initiated stormwater retrofits in the public right-of-way must, at minimum, use the Presumptive Approach, unless the Performance Approach is more appropriate. A stormwater retrofit in the public right-of-way may trigger other public works requirements, such as Portland City Code Title 11 requirements or sidewalk improvements.

City capital, operating or non-operating projects provide local or regional system-specific improvements as identified in an approved and adopted system or facilities plans. These projects include, but are not limited to, improved sewer capacity, improved water quality, habitat improvements for Endangered Species Act compliance, or other environmental requirements. The project's adopted goals to meet specific regulatory requirements may differ from SWMM requirements. In the absence of system or project specific goals, retrofits should meet the system-specific SWMM requirements for pollution reduction and flow control, as appropriate.

1.2.4 Exemptions

Certain development or project conditions are exempt from meeting stormwater management requirements. All exemptions are subject to BES review and must still identify a discharge location; exemptions may not be allowed in circumstances where regulatory permits or other municipal regulations may be violated if the exemption is allowed. The following circumstances are exempt from meeting stormwater management requirements:

- Temporary structures as defined by Portland City Code 17.38.
- Residential structures being re-built following fire damage, flooding, earthquake, or other natural disaster, as long as the structure is re-built at the same scale and discharging to the same disposal point. Expansions to the original footprint, such as an addition or alteration to the original structure, trigger stormwater management requirements for the new impervious area.
- Interior remodeling projects and tenant improvements.
- Maintenance activities, such as top-layer grinding (grind and overlay), repaving when aggregates or gravels are not exposed, or reroofing when the structure or existing plumbing is not altered. However, when an ecoroof or other stormwater management facility is added as part of a maintenance activity, the requirements for owner-initiated stormwater retrofits apply.
- Maintenance of existing culverts or water crossing structures in drainageways are exempt from drainage reserve requirements. Replacement of culverts or water crossing structures would trigger conveyance requirements through review of the proposed channel encroachment.
- Standalone projects that consist solely of safety improvements or to meet Americans with Disability Act standards for stairs, ramps, curbs, corners, or medians that install accessibility and pedestrian safety features. Examples include rapid flash beacons or concrete curb extensions for pedestrian accessibility or safety.
- Standalone projects that consist solely of linear utility trenching in paved public rights-of-way or on private property.
- Base repair of public streets where less than or equal to 50% of the street width is removed and repaved. If the 50% threshold is exceeded during the design phase, stormwater management requirements apply.

- Replacing catch basins or inlets that discharge to the same storm or drainage system are not considered a new connection or a new offsite discharge as long as the cumulative impact to the receiving system remains the same following project completion.
- Building soft surface trails within the drainage reserve encroachment area are exempt from drainage reserve requirements as long as they meet the [Portland Parks and Recreation Trail Design Guidelines](#).

Sidewalks and Driveways

Where it is not feasible for sidewalks and driveway aprons in the public right-of-way to drain into or sheet flow to a stormwater facility, tree well, or landscape strip in the public right-of-way, project designers are encouraged to use street trees for tree credit or to install pervious pavement with pre-approval from the Bureau of Transportation. Tree species and locations in the public right-of-way must be approved by Urban Forestry and Portland Bureau of Transportation through the Public Works Permit process. It is not expected that a separate stormwater management facility be constructed in the public right-of-way to serve only sidewalk or driveway apron areas in the public right-of-way.

Projects on private property that are otherwise subject to the requirements of the SWMM may be exempt from providing a separate stormwater facility for drainage basins that, in total, include less than or equal to 500 square feet of pedestrian-only impervious surface or residential driveway. Applicants must demonstrate that runoff from those basins cannot be routed to other proposed stormwater management facilities. Runoff from those basins must shed to adjacent vegetation or other pervious areas on property where feasible. This exception is still subject to BES review, the specific needs of the stormwater system proposed to receive the runoff, and other regulatory requirements.

Port of Portland Stormwater Design Standards Manual

Any development or redevelopment project at the Portland International Airport (PDX) that meets all of the following applicability requirements is required to meet the Port's Stormwater Design Standards Manual and is exempt from the SWMM:

- The project is located at PDX within the airfield security fence or is on Port-owned and operated property outside the fence (see Figure 1-4); and
- Stormwater is discharged entirely to the Port's storm sewer system.

The Port of Portland will issue a Service Agreement Letter for projects required to use the DSM. The Service Agreement Letter will confirm that the scope of the

project falls under DSM applicability and acknowledges the Port’s responsibility to ensure that the design, operations, and maintenance of the stormwater management facilities, source controls, and systems will meet DSM and MS4 permit requirements.

Figure 1-3. Potential Port of Portland Areas Exempt from the SWMM

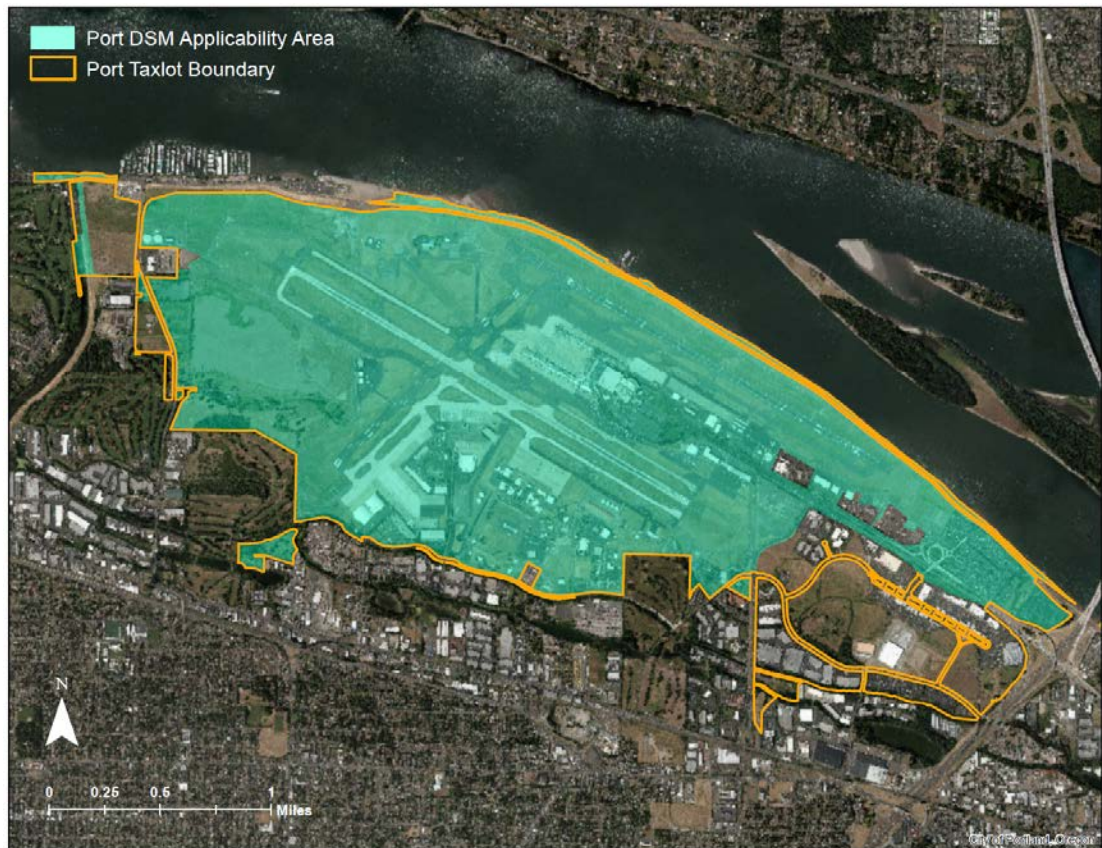

Current as of 2016; official boundaries maintained by the Port of Portland; visit www.portlandmaps.com or contact Port of Portland staff to determine applicability of this exemption.

1.3 Stormwater Management Requirements

Portland has three primary types of systems for conveying and managing stormwater: infiltration, stormwater systems, and combined sewers. Portland's stormwater management requirements are system-specific and are used in order of preference via a stormwater infiltration and discharge hierarchy. [Section 1.3.1](#) establishes the City's stormwater hierarchy of how stormwater must be managed. The following sections correspond to the specific hierarchy categories and provide system-specific pollution reduction and flow or volume requirements:

- [Section 1.3.2](#) discusses impervious area reduction techniques, such as ecoroofs, pervious pavement, and tree credit.
- [Section 1.3.3](#) establishes the stormwater requirements for surface and subsurface infiltration (stormwater hierarchy categories 1 and 2), including Underground Injection Control requirements.
- [Section 1.3.4](#) establishes the stormwater management requirements for discharge to surface water, stormwater or drainage networks, and stormwater systems (stormwater hierarchy category 3).
- [Section 1.3.5](#) establishes the stormwater management requirements prior to discharge to the combined sewer system (stormwater hierarchy category 4).

[Section 1.3.6](#) discusses stormwater master planning and [Section 1.3.7](#) summarizes the stormwater management requirements for all three types of systems (infiltration, stormwater system, and combined sewer).

The City's stormwater management approach relies on the use of vegetated infiltration facilities to comprehensively meet multiple requirements. Vegetated facilities meet infiltration, pollution reduction, and flow and volume control requirements for system-specific stormwater requirements. Vegetated facilities, included in [Chapter 2](#) under the Simplified Approach or Presumptive Approach, are assumed to meet Portland's pollution reduction requirements.

Vegetated facilities filter and infiltrate stormwater, removing pollutants as the water flows through the vegetation and soil. Vegetation may be one of the most cost-effective and ecologically efficient means available to improve water quality. It shades watercourses, which lowers water temperature; captures and absorbs water in leaves and roots, which reduces peak flows; and stabilizes soil by providing cover for disturbed soils. Vegetation also provides wildlife habitat and scenic and aesthetic benefits.

As stormwater enters a vegetated facility, the vegetation slows the water down, allowing sediments to be trapped on the surface of the facility. Typically, the surface area of the facility is designed to allow stormwater to pond and evaporate while sediments settle into a layer of mulch and then soil. The mulch prevents soil erosion and retains moisture for plant roots. It also provides a medium for biological growth and the decomposition or decay of organic matter. The soil stores water and nutrients to support plant life. Bacteria, nematodes, and other soil organisms degrade organic pollutants such as petroleum-based compounds. They also help mix organic material, increase aeration, and improve water infiltration and water-holding capacity. Bacteria and other beneficial soil microbes process the majority of pollutants.

1.3.1 Infiltration and Discharge Hierarchy

Prior to development, most native soils have a sufficient duff layer and permeability to absorb and infiltrate rainwater. This is because of a combination of factors, including the structure of the soil, the connected pores and channels created by plant roots, and the presence of leaf litter and other organic matter. Because most rainstorms are not large enough to exceed the soil permeability and completely saturate the native and undisturbed soil, only a small percentage of water collects on the surface. Under these conditions, water that accumulates at the surface typically collects in rivulets that combine to form creeks, streams, and rivers.

Urbanization results in the loss of native soil conditions as a result of soil compaction and the creation of impervious surfaces, which disrupts the hydrologic cycle. Impacts include increased stormwater flow rates and volumes as well as decreased groundwater recharge and, consequently, low base flows into streams. Urbanization also has serious impacts on the quality of surface water and groundwater. As land is developed, impervious areas interfere with the natural biological processes of soil that remove impurities from the water and also increase stormwater runoff. The increased flows pick up pollutants from impervious areas and transport them downstream to receiving waters and the City sewer system.

Portland's infiltration and discharge requirements are designed to:

- Protect groundwater resources by preventing and removing pollutants from stormwater before discharging it into an underground injection control or other water pollution control facility.
- Protect watershed health by requiring infiltration wherever feasible in order to mimic pre-development hydrologic conditions.

- Minimize long-term costs to the City of treating stormwater flowing through a public wastewater treatment plants.
- Protect the capacity of downstream infrastructure.
- Minimize CSOs and basement sewer backups within the combined sewer system.

Feasibility

Stormwater must be infiltrated onsite to the maximum extent feasible, before any flows are discharged offsite. The term “onsite” refers to the limits of the project site, and is not a distinction between property and the right-of-way. For example, a residential development proposal could manage the runoff from the building onsite (on private property) via drywells and the runoff from the frontage improvements onsite (in the public-right-of-way) through a vegetated planter. While development proposals on property may be bound by the parcel or taxlot geometry, the term “onsite” can be used to describe meeting the stormwater infiltration discharge hierarchy for any type of project.

The appropriate use of infiltration depends on a number of factors, including soil type, soil conditions or contamination, slopes, and depth to groundwater. The discharge location is also site-specific and dependent on the availability and condition of public and private infrastructure. The feasibility of infiltration and the discharge location have a direct impact on the system-specific pollution reduction and flow control requirements for a site. Therefore, it is critical to determine the feasibility of infiltration and the discharge location before designing a stormwater management plan. Infiltration testing is required to determine the feasibility of onsite infiltration and the existing infiltration rate.

While many of the stormwater management facilities presented in [Chapter 2](#) aim to maximize infiltration, not every site can infiltrate all of the stormwater from large, intense rainfall events, as determined by a standard design storm. A design storm is a theoretical rainfall event at a specified recurrence interval with given rainfall depth over a given time period. Unless complete infiltration of Portland’s 10-year design storm (3.4 inches of rainfall over 24 hours) can be accomplished, an offsite discharge location must be identified.

Vegetated facilities are required to the maximum extent feasible. If a project proposes to use facilities other than those presented in [Chapter 2](#) for pollution reduction, the project designer must demonstrate through the Performance Approach that the proposal meets or exceeds the pollution reduction requirements.

BES has the authority to determine if infiltration is feasible, including approving or denying requests to infiltrate onsite or to discharge offsite from private and public properties or the public right-of-way.

Stormwater Hierarchy

Decisions regarding the degree of onsite infiltration and the discharge location (when complete onsite infiltration is not feasible) are based on the stormwater hierarchy, as shown in Figure 1-4 and Figure 1-5. Following any use of impervious area reduction techniques, the highest technically feasible category must be used (1 = highest, 4 = lowest), unless otherwise directed by BES. Project designers must provide the appropriate technical analysis and evaluation to demonstrate the need to move from Category 1 through each consecutive category.

It is the responsibility of the project designer to justify moving from one category to the next, based on technical issues or competing requirements. These circumstances are evaluated on a site-by-site basis. All circumstances are subject to BES review and approval. Even if full onsite infiltration is not feasible, partial infiltration via unlined facilities may still be safe and appropriate prior to offsite discharge. If onsite infiltration is not feasible, onsite stormwater management that overflows to an offsite discharge location is required.

Figure 1-4. Stormwater Hierarchy Illustration

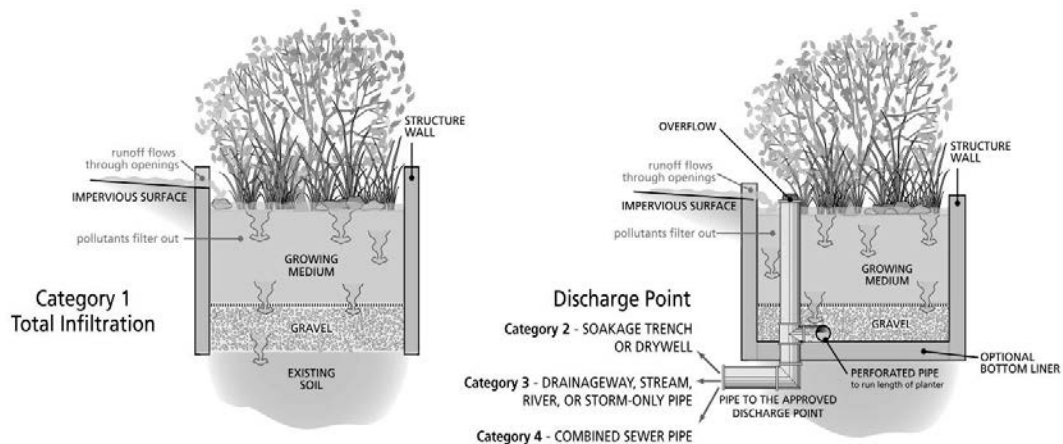
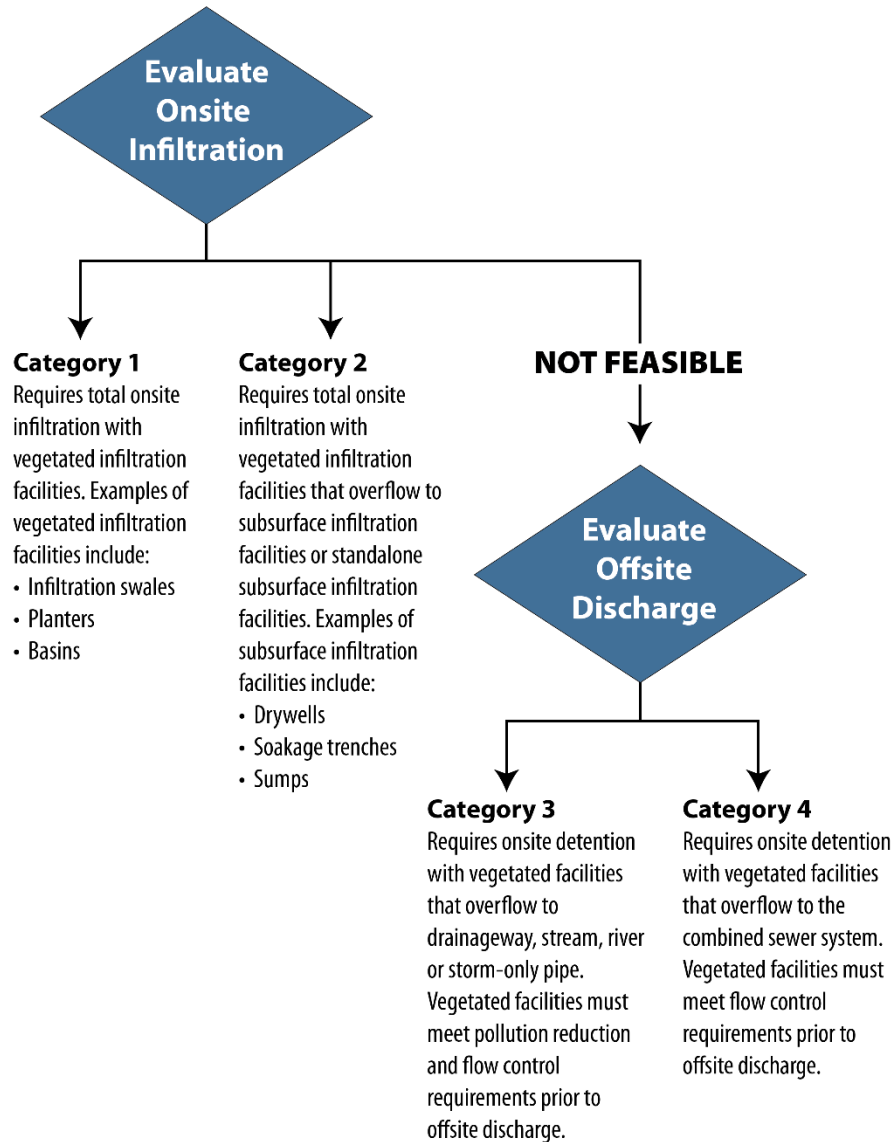

Figure 1-5. Stormwater Infiltration and Discharge Hierarchy

Impervious Area Reduction Techniques

Using impervious area reduction techniques can reduce the amount of impervious area that requires stormwater management. Examples of impervious area reduction techniques include ecoroofs, trees, and pervious pavement.



City of Portland Environmental Services ES1604

1.3.2 Impervious Area Reduction Techniques

Impervious area reduction techniques can help mitigate the impacts of development by reducing the amount of stormwater runoff generated. Impervious area reduction techniques can mimic the passive treatment of pre-development conditions and can reduce the amount of impervious area that requires stormwater management by intercepting rainfall directly.

Ecoroofs, trees, and pervious pavement are considered impervious area reduction techniques and should be considered first as site conditions allow. Use of impervious area reduction techniques are not required to meet system-specific stormwater requirements, but other site requirements or constraints may require their use in order to meet system-specific stormwater requirements. Ecoroofs and trees can be used without consideration of onsite infiltrate rates, while pervious pavement does require infiltration testing to determine feasibility. Impervious area mitigated by ecoroofs is allowed to overflow to an approvable offsite discharge location.

1.3.3 Infiltration Requirements (Categories 1 and 2)

Stormwater Infiltration and Discharge Hierarchy Categories 1 and 2 include the infiltration of stormwater onsite.

Onsite infiltration is required. The City may require a certified geotechnical engineer, engineering geologist, or other qualified individual to demonstrate that infiltration is not technically feasible. Infiltration may not be required under the following circumstances:

- The site is located within a wellhead protection area and must meet the Water Bureau's requirements for protection of groundwater resources (see [Section 1.1.3](#) for an overview of the Title 21 (Water) requirements). If infiltration is feasible, structural spill control may be required prior to infiltration facilities.
- The site has seasonally high groundwater of less than five feet below the lowest elevation of the infiltration facility.
- The site has low infiltration rates of less than 2.0 inches per hour as proven by infiltration testing.
- The placement of an infiltration facility does not meet site and slope setbacks as per [Chapter 2](#). All setback requirements are minimums and can be increased, based on the discretion of City of Portland staff.

- The site has suspected or known soil or groundwater contamination. See the [BES Source Control Manual](#) for more information. Full site assessment may be required to determine feasibility of onsite infiltration.

If infiltration is not feasible, onsite stormwater management that overflows to an offsite discharge location is required (see [Section 1.3.4](#) Stormwater System Requirements (Category 3) and [Section 1.3.5](#) Combined Sewer System Requirements (Category 4) for requirements for discharging to either of these offsite discharge locations). Where complete onsite infiltration is feasible, the following standards apply:

Surface infiltration facilities. Surface infiltration facilities must infiltrate Portland’s 10-year design storm (3.4 inches over 24 hours). When full, the facility drawdown time must not exceed 30 hours. [Chapter 2](#) provides detailed facility sizing and design procedures.

Infiltration sump systems. The peak flow rate from a 10-year storm must be managed with a safety factor of 2 applied. The intensity must correspond to the calculated time of concentration (5-minute minimum). See the *Sewer and Drainage Facilities Design Manual* for rainfall intensity charts. For 5-minute time of concentration, Intensity = 2.86 in./hr.

Drywells and soakage trenches. Drywell or soakage trench sizing requirements found in [Section 2.3.4](#) must be used. When full, the facility drawdown time must not exceed 30 hours. Drywells and soakage trenches must be able to meet boundary, site, slope, building, and structure setbacks.

Rooftop or pedestrian-only plaza runoff. Projects that infiltrate stormwater runoff directly from rooftops or pedestrian-only plazas using underground or subsurface infiltration (e.g., private soakage trenches or drywells) are not required to provide additional pollution reduction prior to subsurface infiltration.

Underground Injection Control (UICs)

UIC Regulations

This section provides general UIC information only. Complete UIC regulations, requirements, current exclusions or exemptions, and contact information are available on the [DEQ UIC Program](#) website. DEQ Water Quality Division UIC Program must provide authorization before constructing, operating, modifying, or decommissioning any UIC.

Additional information on protection of groundwater resources through Wellhead Protection Program Areas (WPA's) can be found at the [Portland Water Bureau Groundwater Protection Program](#) website.

Underground Injection Control (UIC) systems are regulated under the federal Safe Drinking Water Act (administered by DEQ) and the State Plumbing Code. DEQ regulates UICs under Oregon Administrative Rules 340-40 and 340-44.

DEQ defines a UIC as any system, structure, or activity that is intended to discharge fluids below the ground surface. UICs can pollute soil and groundwater if not properly designed, sited, and operated. Stormwater systems such as, but not limited to, sumps, drywells, and soakage trenches are examples of UICs subject to DEQ regulation. DEQ can also classify other systems as UICs, depending on the design. Additional information about UIC determination is available on the DEQ website noted above. Examples of systems that DEQ can classify as UICs are provided below, along with criteria to help determine when the system is or is not a UIC:

- DEQ generally does not currently classify surface infiltration facilities such as pervious pavements, swales, planters, and basins as UICs.
- An assemblage of perforated pipes, drain tiles, or other similar mechanisms, including French drains, designed and intended to collect and convey infiltrated stormwater to another disposal or discharge location, is not classified as a UIC. However, the final discharge location receiving stormwater from the collection or conveyance system may be classified as a UIC. If the final discharge location is below the ground surface, the system is generally classified as a UIC.
- Infiltration facilities whose depth is greater than its largest surface dimension are generally classified as a UIC.
- When pervious pavement is designed with perforated pipe(s) to convey the stormwater to another point of discharge, DEQ does not currently classify the system itself as a UIC; however, the point of discharge may be classified as a UIC.

When pervious pavement is designed with a trench that is deeper than it is wide or with perforated pipe(s) under the pervious pavement, DEQ may classify the pervious pavement as a UIC. Utility trenches such as water, sewer, and gas lines are exempt from this classification.

If it is difficult to determine whether the proposed stormwater system design is or is not a UIC, it is best to consult with DEQ.

DEQ UIC Registration

Owners or operators of new and existing public or private UICs are required to register and provide site inventory data to DEQ. UICs collecting runoff only from single-family or small multi-family (up to two attached units) residential roofs and footing drains are excluded from UIC authorization requirements.

This section of the manual focuses on proposed public or private UICs for new construction and redevelopment, including UIC closures. The difference between a public and private UIC is as follows:

- **Public UIC:** A public UIC collects stormwater from City-owned or managed facilities, including roofs, parking lots, and other impervious surfaces; and public rights-of-way owned or managed by the City of Portland.
- **Private UIC:** A private UIC collects stormwater from private property, including roofs, parking lots, and other impervious surfaces, and discharges it to an onsite UIC. The onsite UIC is managed by the private property owner.

DEQ UIC Rule Authorization

Private UICs are required to be rule authorized as described on the DEQ website. If the private system cannot be rule authorized, then a permit would be required. DEQ has issued a WPCF permit to the City to construct and operate public UICs as specified within the permit. The permit requires the City to develop and implement a comprehensive management plan that details how the City will construct, operate, and evaluate UICs to ensure compliance with permit requirements. Because of the City's permit, the registration and permitting process for proposed City-owned UICs is different than for rule authorization or permitting of private UICs.

Constructing new City-owned UICs. The City of Portland manages the registration and permitting for City-owned UICs proposed for construction, redevelopment, or decommissioning. To ensure a timely rule authorization process, it is critical for public works permit applicants to notify the City immediately once they have determined that UICs may be used for stormwater discharge from the public right-of-way. The City will complete the process in accordance with the requirements of

the City's WPCF permit. Notice to proceed will be given when the City determines that the proposed UIC meets permit requirements.

Constructing new private UICs. For private development or redevelopment using UICs for stormwater discharge, applicants must apply directly to DEQ for rule authorization or permitting before constructing the UIC. A City building or plumbing permit does not authorize the construction of a UIC on private property; only DEQ can authorize a UIC. DEQ processes UIC registration and rule authorization applications for UICs serving private property within two weeks of a completed application and receipt for payment. For questions regarding registration, application requirements, or payment, please refer to the [DEQ UIC website](#) for information, applications, and staff contacts.

Depth to groundwater investigations. Part of the rule authorization and permitting process requires both public and private UICs to have a minimum separation distance of 5 feet between the bottom of the UIC and the seasonal high groundwater level. Several areas within the City are known to have shallow groundwater. Within areas of known or suspected shallow groundwater, additional information about depth to groundwater (DTW) must be collected to ensure the bottom of the proposed UIC meets separation distance requirements.

If additional depth to groundwater information is requested, refer to [Section 2.3.6](#), Depth to Groundwater Investigation for requirements.

For public or private UICs proposed within the 50-foot groundwater contour of the estimated depth to seasonal high groundwater, the project designer must provide the site-specific DTW investigation. One of the following methods must be used to obtain the DTW measurement:

- Install a temporary piezometer.
- Use existing onsite or nearby high-quality shallow groundwater level data.

For DTW investigation installation, DTW measurement, and reporting requirements and criteria for using existing data, see [Section 2.3.6](#).

DEQ UIC Decommissioning Process. The decommissioning, or closure, of a UIC system requires submittal of a completed pre-closure notification application to DEQ prior to closure. The difference between decommissioning public or private UICs is as follows:

- Public UICs: BES manages the pre-closure application submittal process for City-owned UICs proposed to be decommissioned. The City will complete the

decommissioning process in accordance with the City's [UIC Management Plan, Appendix D: Decommissioning Procedure for UIC Systems](#).

- Private UICs: DEQ requirement for UIC decommissioning may be found on the DEQ website. A City building or plumbing permit does not authorize the decommissioning of a UIC on private property. If stormwater is redirected from a private UIC to a City stormwater or drainage system, that stormwater must meet the requirements of the SWMM, as per [Section 1.2, Applicability](#).

Discharge to UICs

BES will allow new or redeveloped impervious areas in the public right-of-way, private streets, driveways, or small parking lots to discharge to existing or new UICs without the installation of new or additional vegetated stormwater management facilities only if the UIC meets all of the following:

- New UICs must meet all current DEQ requirements and current standard design and capacity requirements as given in the current SWMM or the *Sewer and Drainage Facilities Design Manual*. New UICs do not need to be rule authorized prior to plan review.
- Existing public UICs must be compliant with all DEQ requirements as given in the City's WPCF Permit and must meet current design standards and capacity requirements as given in the current SWMM or the *Sewer and Drainage Facilities Design Manual*.
- The UIC must accept runoff only from areas draining from paved private streets or paved rights-of-way on residential streets that receive less than 1,000 trips per day; residential driveways; or from small parking lots that have less than 50 uncovered parking lot spaces and receive less than 1,000 trips per day.
- The UIC must meet current depth-to-groundwater requirements.
- Existing UICs must have available capacity to receive additional runoff. If existing facility records cannot determine capacity, BES may require testing of the UIC to determine available capacity.
- The UIC must include pollution reduction and spill control prior to underground injection. For UICs in the public right-of-way or on private streets, the UIC must have a sedimentation manhole built to current standards. For UICs in driveways or small parking lots, the UIC must have a lynch-style catch basin as approved by BDS. The project designer will be required to upgrade existing UICs to meet this condition.

If the UIC does not meet the characteristics above, a vegetated stormwater management facility will be required for pollution reduction prior to discharge to a UIC.

1.3.4 Stormwater System Requirements (Category 3)

Stormwater Infiltration and Discharge Hierarchy Category 3 includes managing stormwater onsite with discharge to a stormwater drainage or conveyance system. Stormwater drainage or conveyance systems that may be an approvable discharge point include public or private ditches, constructed or natural drainageways, manmade channels, creeks, streams, storm-only sewers, or rivers. Discharge to stormwater systems requires consideration of conveyance and capacity, flow control, and pollution reduction requirements, all of which may vary depending on the type and location of the receiving stormwater system. Stormwater management requirements protect local waterways from the cumulative impacts of development by limiting site and offsite impacts, controlling runoff and erosion, and maintaining capacity. Managing stormwater impacts through vegetated stormwater facilities and conveyance features also help meet additional City goals of protecting and enhancing biological diversity and habitat.

Conveyance Requirements

Stormwater systems have conveyance requirements that vary by the location and type of stormwater system. Project designers proposing to discharge stormwater to a stormwater system must evaluate the conveyance capacity of the receiving system (storm sewer, ditch, drainageway, etc.). BES staff may determine that additional requirements are necessary (such as infrastructure upgrades, flow control or drainage reserve width) if the receiving system does not have sufficient capacity to accept the proposed flows.

Discharge to or Modification of Onsite Drainageways

A drainageway is a constructed or natural channel or depression which may collect and convey water at any time. Drainageways convey flow and minimize scouring, erosion and water quality degradation in local stream systems. Drainageways must be carefully considered when properties are developed, regardless of whether the drainageways are naturally occurring or have resulted after water has been moved, shifted, or modified as part of earlier site disturbance, developments or actions.

BES will determine if a drainageway exists by using the following tools: satellite imagery; existing development plans; aerial photos; LiDAR maps; hydrologic, hydraulic and flow models; existing infrastructure; topography; physical site

characteristics including vegetation, soils, and habitat; information gathered from site visits; and other information. During site visits, BES will look for indicators of stormwater or natural conveyance (see factors listed in [Section 2.1.2](#)). Indicators may be present in wet or dry seasons or both. The determination of an onsite drainageway does not depend on water being present, only on factors that demonstrate the presence of water and flow at some point in time.

DRAINAGE RESERVES

A drainage reserve is the regulated area adjacent to and including a drainageway that must be preserved in a natural state to protect the hydrology and water quality of the drainageway. A drainage reserve is a key element in maintaining conveyance between properties; protecting public and private stormwater infrastructure, property and structures; and protecting and maintaining the quality of surface waters.

BES will place a 30-foot wide drainage reserve over any portion of a property with flow conveyance features that meet the drainageway definition and that are not adequately protected by environmental protection zoning or land use requirements. If the environmental protection overlay zones or tracts are insufficiently sized to cover the drainageway width, drainage reserves may be placed in conjunction with these other protection methods to ensure adequate protection of the full desired width for flow conveyance. In making a determination to place a drainage reserve over a drainageway, BES will evaluate the factors listed in [Section 2.1.2](#). Placement of a drainage reserve may be based on any combination of indicators; not all of the indicators must be present.

A drainage reserve is a no-disturbance area for the purposes of the proposed site development, unless approved by BES. A drainage reserve acts as a no-disturbance area, not an easement, providing a buffer that protects the drainageway from development impacts. Similar to a setback, no structures are allowed in drainage reserves, unless the disturbance is approved by BES.

BES retains the authority to modify or remove drainage reserves if the drainageway poses or may pose a risk to public health, safety or the environment. In those instances, BES may allow drainageways to be modified to protect public health and safety, in compliance with Portland City Code Title 24 and 33 regulations.

Drainage reserves run with the land, meaning that the benefits and responsibilities of the drainage reserve are bound to the property and are passed on to any

subsequent owners of the property. Drainage reserves must be protected during the course of any currently proposed or future development to ensure the continuation of flow conveyance and other benefits. Drainage reserves must be protected and maintained to meet the following standards:

- The limits of the drainage reserve must remain in natural topographic conditions to the maximum extent feasible, as determined by BES.
- Vegetation within the drainage reserve limits must not be on Portland’s list of nuisance plants or prohibited plants. Any proposed vegetation must be native vegetation, especially for erosion control and water quality purposes.

Applicants are required to meet the standards for drainage reserves (see [Chapter 2](#)) or request an encroachment to review site-specific conditions (see [Section 2.4.7](#) Drainage Reserve Submittal Guide for encroachment submittal requirements). If any encroachments into the drainageway channel or drainage reserve are proposed, identification of the upstream tributary drainage and a downstream analysis must be provided to the City to determine whether there will be any impacts to the drainageway conveyance, water quality, or any public infrastructure within the drainage. The analysis required will depend on the cumulative impact of problems identified within the basin and the size of the planned project. Because drainageways serve important hydrologic, hydraulic, and water quality functions for small waterways, BES may require that applicants demonstrate that the proposed encroachments do not affect storage or conveyance volumes or the water quality of the drainageway.

Offsite Discharge to Surface Flow

Where stormwater is discharged to an offsite surface flow conveyance facility, such as a ditch, drainageway, stream, or river, the following standard applies:

- Beginning at the point of discharge from the site, the surface conveyance facility must have the capacity to convey flows from the 25-year design storm from all contributing upstream drainage areas. If the offsite surface flow conveyance facility is in the public right-of-way or owned or maintained by the City of Portland, the Sewer and Drainage Facilities Design Manual requirements for freeboard also apply.

Offsite Discharge to Piped Flow

Where stormwater is discharged to an offsite piped conveyance facility, such as a storm sewer, the following standards apply:

- For new development or redevelopment with an increase in net impervious area, beginning at the point of discharge from the site, the piped conveyance facility must have the capacity to convey flows from the 10-year storm from all contributing upstream drainage areas without surcharge. The piped conveyance facility may surcharge during the 25-year storm, but the hydraulic grade line must remain below ground surface level.
- Sewers in the Cascade Station/Portland International Center and Columbia South Shore Plan Districts must have the capacity to convey flows from the 25-year storm without surcharge.
- For redevelopment with no net increase in impervious area, existing downstream pipe conveyance facilities may be allowed to surcharge under certain circumstances.

Flow Control Requirements

Stormwater systems have flow control requirements which vary by location and type of stormwater system. The basic concept for flow control (detention and retention) is that water from developed areas is managed with a variety of techniques and released to downstream conveyance systems at a slower rate and lower volume. Managing flows in this way attempts to mimic the natural rainfall runoff response of the site in an undeveloped state, protecting downstream properties, infrastructure, and natural resources from the increases in stormwater runoff peak flow rates and volumes that result from development.

DETENTION AND RETENTION

Detention facilities store stormwater and release the water slowly. In the case of surface vegetated detention facilities, stormwater is evapotranspired, reducing the total volume of water released by the facility.

Retention facilities also store stormwater. Rather than storing and releasing the entire runoff volume, however, the facility permanently retains a portion of the water onsite. The water infiltrates and recharges the groundwater aquifer and, in the case of surface retention facilities, evaporates or is absorbed and used by vegetation. In this way, retention facilities reduce the total volume of water released by the facility.

Systems such as pervious pavement, ecoroofs, planters, swales, and other surface vegetated facilities are particularly effective in lowering the overall runoff volume and reducing the amount of time (duration) and frequency of the peak flow rate. In

addition, by infiltrating stormwater, vegetated retention systems recharge groundwater that serves as the base flow for streams during the dry season. Stream systems that require erosion protection, including streams with salmonid habitat, warrant the use of retention systems. Where retention systems cannot be used, detention systems that control the duration of the geomorphically significant flow (i.e., flow capable of moving sediment) must be used. Such detention systems lower release rates and must be designed to protect the stream channel.

Time of concentration (the time it takes rainfall to accumulate and run off a site) is another important factor in determining hydraulic impacts created by development on the receiving system. Flow rates and volume from individual sites may be controlled, but when they are combined quickly in fast-flowing conveyance pipes, the effect will still be increased in-stream flow rates and volumes in the receiving system. Breaking flow patterns up into retention systems helps increase a site's time of concentration and lessens impacts on the receiving system.

The City's flow control requirements aim to ensure that post-development storm flows leaving the site:

- to the maximum extent possible, mimic the storm flows of the site prior to development
- do not exceed the capacity of the receiving system or water body
- do not increase the potential for stream bank and stream channel erosion
- do not add significant volume to an existing closed depression
- do not create or increase any upstream or downstream flooding problems

Flow control standards vary, depending on the point of discharge. The base standard must be sufficient to maintain peak flow rates at their predevelopment levels for the 2-year, 5-year, and 10-year, 24-hour design storms.

Flow control requirements when discharging to a stream or drainageway.

Most tributary streams in Portland show evidence of excessive stream bank and channel erosion. Any development that discharges stormwater offsite that eventually flows to a tributary stream must be designed to a more restrictive requirement to reduce the potential to further exacerbate in-stream erosion problems. This applies to all tributaries and storm sewers that drain to streams or overland storm drainage systems within the Portland area except the Columbia Slough, which is regulated by Multnomah County Drainage District.

Flow control in these areas should avoid discharging flows that will cause channel erosion. Channel-eroding flow varies from stream to stream. Unless more specific data are available, the City assumes that channel-eroding flow is one-half of the 2-year, 24-hour pre-development design storm peak flow. The 2-year, 24-hour post-development peak flow rate must be restricted to one-half of the 2-year, 24-hour pre-development design storm peak flow. The facilities must also control the post-development flows from the 5-, 10-, and 25-year, 24-hour design storm peak flows to the predevelopment 5-, 10-, and 25-year design storm at 24-hour levels.

Flow Control Exemptions. New development and redevelopment projects may be exempt from flow control requirements if they discharge stormwater runoff directly into the Willamette River, Columbia River, or Columbia Slough through a private storm sewer, separated public storm sewer, or Multnomah County Drainage District system with available capacity.

When flow control is not required, facilities may be downsized, but they still must be designed to meet pollution reduction requirements. (Facilities sized with the Simplified Approach are presumed to meet both flow control and pollution reduction requirements.) When facilities are downsized through the Presumptive or Performance Approach to meet pollution reduction requirements only, flows above the pollution reduction design flow must be routed around the facility with an approved diversion structure, unless otherwise approved by BES.

Pollution Reduction Requirements

The City of Portland has the following pollution reduction requirements:

- Seventy percent removal of total suspended solids (TSS) is required from 90 percent of the average annual runoff. (See [Appendix A.3](#) for more detailed information about the formulation of Portland’s pollution reduction standards.)
- In watersheds that have established total maximum daily loads (TMDLs) or that are on DEQ’s 303(d) list of impaired waters, stormwater management facilities must be capable of reducing the pollutant(s) of concern, as approved by BES.

Total Suspended Solids (TSS) Requirements

TSS comprises particles that are too small or light to settle out from stormwater under high flow conditions. In many ways, TSS is a surrogate measure for water quality; therefore, the percentage of TSS removal from stormwater is an accepted standard to measure pollution reduction.

- Projects may use facilities from the Simplified or Presumptive Approach (as specified in Chapter 2) to meet the 70 percent removal of TSS from 90 percent of the average annual runoff, without submitting additional data on TSS removal.
- If a project does not use facilities from the Simplified or Presumptive Approach, the project designer must demonstrate through the Performance Approach (as specified in Chapter 2) that the development proposal meets the specific TSS removal requirements.

Total Maximum Daily Load (TMDL) and 303(d) List Requirements

Development projects in watersheds with established TMDLs or on DEQ's 303(d) list (see Figure 1-7. TMDL and 303(d)-Listed Parameters by Watershed) may use vegetated facilities from the Simplified Approach or Presumptive Approach (as specified in Chapter 2) without submitting additional data on pollutant removal.

- If a project in a watershed with established TMDLs or on the 303(d) list does not use facilities from the Simplified or Presumptive Approach, the project designer must demonstrate through the Performance Approach (as specified in Chapter 2) that the development proposal is consistent with specific TMDL or 303(d) requirements. The base requirement is to select and use a stormwater management facility that is capable of reducing the pollutants of concern, as approved by BES. TSS may be used as a surrogate for aldrin, chlordane, DDE, DDT, dieldrin, dioxin, and PCBs.

Rate and Volume Pollution Reduction Standards

Facilities sized by routing a hydrograph through the facility (rate-based facilities with a storage volume component) may use a continuous simulation program (using a minimum of 20 years of Portland rainfall data) or a single-storm hydrograph-based analysis method, such as the Santa Barbara Urban Hydrograph (with 0.83 inches of rainfall over 24 hours and NRCS Type 1A rainfall distribution), to demonstrate treatment of 90 percent of the average annual runoff volume. (See [Appendix A.3](#) for more detailed information about the formulation of Portland’s pollution reduction standards.)

Volume Pollution Reduction Standards

Volume-based facilities are designed to treat runoff generated by 0.83 inches of rainfall over 24 hours (with NRCS Type 1A rainfall distribution) with a volume of basin/volume of runoff ratio of 2 and will treat roughly 90 percent of the average annual runoff.

Flow-Rate Pollution Reduction Standards

Flow rate-based pollution reduction facilities, such as grassy swales or sand filters, must be designed to treat runoff generated by a rainfall intensity of 0.19 inches per hour at a 5-minute Time of Concentration. Table 1-2 provides the rainfall intensities for a longer Time of Concentration.

Table 1-2. Rainfall Intensity to Calculate Treatment of 90% of Portland’s Average Annual Runoff

Site’s Time of Concentration (Minutes)	Rainfall Intensity (inches per hour)
5	0.19
10	0.16
20	0.13

The rainfall intensities must be to calculate pollution reduction runoff rates for rate-based pollution reduction facilities.

Manufactured Stormwater Treatment Technologies

There may be sites where it is not technically feasible to use stormwater facilities under the Simplified or Presumptive Approach to meet all stormwater management requirements. Subject to BES approval, manufactured stormwater treatment technologies may be considered for sites in separated storm sewer areas where

slope and infiltration limitations prevent the use of any reasonably located vegetated facilities (lined or unlined). Manufactured stormwater treatment technologies may also be considered where site constraints limit or prevent facility sizing for the water quality storm (0.83 inches in 24 hours). In those instances, approved manufactured stormwater treatment technologies may be proposed for pollution reduction.

BES maintains a list of approved manufactured stormwater treatment technologies (see [Chapter 2](#)). Project designers may select manufactured stormwater treatment technologies that are on the approved list and use the Performance Approach. Manufactured stormwater treatment technologies not on the approved list must be designed under the Performance Approach and require site-specific review and approval.

Approved MSTTs

The list of approved manufactured stormwater treatment technologies is available on the BES website at <http://www.portlandoregon.gov/bes/swmm>.

1.3.5 Combined Sewer System Requirements (Category 4)

Stormwater Infiltration and Discharge Hierarchy Category 4 includes managing stormwater onsite with offsite discharge to a combined sewer system. Substantial stormwater volumes in the combined sewer system may result in sewer releases to surface water, streets, and basements. Stormwater that enters the combined sewer system during low-flow periods is treated at the City's wastewater treatment plants using energy and other resources. For these reasons, it is important to limit the quantity of stormwater entering the combined sewer system. Projects in combined sewer areas are required to infiltrate stormwater onsite to the maximum extent feasible. Vegetated stormwater facilities must be used to the maximum extent feasible.

Project designers proposing to discharge stormwater offsite to a combined sewer system must evaluate the capacity of the offsite receiving system. BES staff may determine that additional onsite flow or volume control is required if the combined sewer system does not have sufficient capacity to accept the proposed flows.

For developments that are served by combined sewers but are unable to achieve more preferred stormwater hierarchy categories, the following requirements apply:

- BES will review development and redevelopment plans to ensure that discharge to a combined sewer system will not increase the risk of an overflow event, basement sewer backups, or diversion to a surface water body, except as intended by the municipal system’s design. Additional requirements may apply depending on the scope and location of the project.
- Detention facilities must be designed to control post-development flows from the 25-year peak flow to the pre-development 10-year peak flow rate.
- For new development or redevelopment with an increase in net impervious area: Beginning at the point of discharge from the site, the piped conveyance facility must have the capacity to convey flows from the 10-year storm from all contributing upstream drainage areas without surcharge. The piped conveyance facility may surcharge during the 25-year storm, but the hydraulic grade line must remain below ground surface level. Combined sewers must have the capacity to convey flows from the 25-year storm without surcharge.
- For redevelopment with no net increase in impervious area: Existing downstream pipe conveyance facilities may be allowed to surcharge under certain circumstances.

In the combined sewer system where flow control is critical to protecting sewer capacity and preventing sewer backups and street flooding, both infiltration and lined systems are very useful tools in reducing risk. For projects in the public right-of-way where full onsite infiltration is not feasible and that propose to discharge to the combined sewer system:

- Facilities that provide infiltration (unlined or otherwise open-bottom) are preferred.
- Lined stormwater facilities and/or piped overflows should only be used where there are local or regional capacity problems and where flow control and other benefits of lined systems have been identified. Stormwater facilities are not allowed to have overflow pipes that connect directly to a combined sewer main without the use of a manhole or other structure unless the project designer can demonstrate that odors will not be conveyed to the surface.
- If there are no local or regional capacity problems, impervious area reduction techniques, such as street trees or pervious pavement, should be prioritized over lined stormwater facilities. If impervious area reduction techniques are not feasible, then a request to pay an Offsite Stormwater Management Fee should be made through the Special Circumstances process ([Section 1.5](#)).

1.3.6 Stormwater Master Planning

Large campus or district-type developments may develop a stormwater master plan to guide phased development over a long period of time. This may include educational, medical, or religious institutions, ecodistricts, large site master plans, planned developments, or other master plans for large development areas. Stormwater master plans may be a required condition of a development agreement or conditional use approval. A stormwater master plan should lay out current and proposed conditions and identify a phased approach to bridge the two conditions. This may include building stormwater facilities in advance of development, discharge to existing stormwater management facilities, incorporating shared facilities, or planned upgrades to existing or proposed facilities to account for managing additional stormwater runoff.

A stormwater master plan may have larger design flexibility within the geographic extent of the master plan boundaries (e.g. the entire master plan area would be considered “onsite”), but would still need to meet the SWMM system-specific requirements at the point of discharge leaving the master planned area during each phase. The master plan may include other land other than is currently controlled by the property owner, but those sections of the master plan would not be able to be implemented until so controlled. Otherwise, if multiple property owners are involved, the stormwater master plan would need to include development agreements; easements; code, covenants and restrictions (CC&Rs); or other binding agreements that would indicate future commitments to implement the stormwater master plan prior to conditional use or other land use approval.

1.3.7 Summary of Stormwater Management Requirements

Projects that meet the applicability thresholds must meet the infiltration and discharge requirements for the impervious area draining to the discharge location, as specified in the stormwater hierarchy. Stormwater management requirements are specific to the receiving stormwater system to which the stormwater will discharge (see Table 1-3 and Figure 1-7). Vegetated facilities must be used to the maximum extent feasible. All projects must comply with Operations and Maintenance requirements.

Table 1-3. Summary of Stormwater Management Requirements

Stormwater Hierarchy Category	Stormwater Management Requirement (unless otherwise exempt)
Impervious Area Reduction Technique	No additional requirements for areas managed by ecoroofs, pervious pavement, or tree credit.
Category 1: Vegetated infiltration facility with no overflow	Infiltrate the 10-year design storm.
Category 2: Vegetated facility or pervious pavement with overflow to subsurface infiltration facility (sump, drywell, soakage trench)	Infiltrate the 10-year design storm and meet underground injection control requirements.
Category 3: Vegetated facility with overflow to drainageway, stream, river, or storm-only pipe	<p>Pollution reduction required:</p> <ul style="list-style-type: none"> • Must achieve 70 percent TSS removal from 90 percent of the average annual runoff. • In watersheds with a TMDL or on DEQ’s 303(d) list of impaired waters, must use a pollution reduction facility that will reduce pollutants of concern. <p>Flow control required for discharge to surface water bodies directly or via stormwater systems, such as ditches or drainageways:</p> <ul style="list-style-type: none"> • 2-year post-development peak runoff rate to one-half of the 2-year pre-development peak rate • 5-year post-development peak runoff rate to 5-year pre-development peak rate • 10-year post-development peak runoff rate to 10-year pre-development peak rate • 25-year post-development peak runoff rate to 25-year pre-development peak rate <p>Flow control required for discharge to storm-only sewers:</p> <ul style="list-style-type: none"> • Maintain peak flow rates at their pre-development levels for the 2-year, 5-year, and 10-year, 24-hour runoff events.
Category 4: Vegetated facility with overflow to combined sewer	<p>Flow control required:</p> <ul style="list-style-type: none"> • Limit the 25-year post-development peak runoff rate to the 10-year predevelopment peak rate

Figure 1-7. Navigating the Stormwater Infiltration and Discharge Hierarchy to meet Stormwater Management Requirements

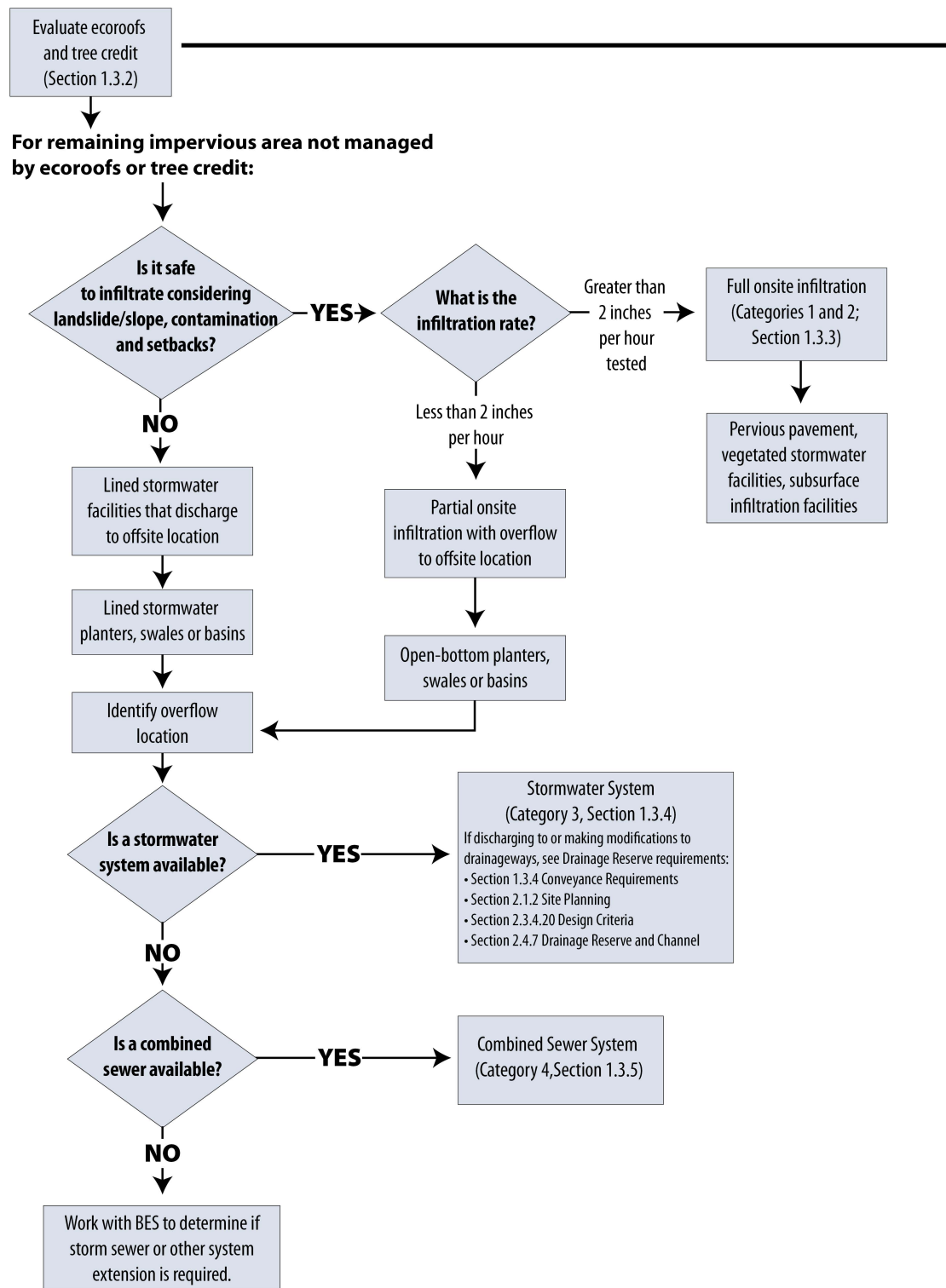

1.4 Operations and Maintenance Requirements

All stormwater management facilities, conveyance features and related components implemented or protected as per the SWMM must be operated and maintained in a way that preserves intended functionality. Chapter 3 contains the Operations and Maintenance (O&M) standards and specifications that meet these requirements. Chapter 3 also contains the submittal guides that establishes the information and documentation that must be submitted to demonstrate compliance with the standards and specifications of Chapter 3. The O&M submittal requirements vary by design approach and whether the facility or conveyance feature is located on private or public property or in the public right-of-way. An O&M Plan is required for conveyance features on properties undergoing development proposal review, regardless of whether or not it is directly associated with a stormwater management facility. An O&M submittal may consist of forms, standard O&M plans, stormwater facility and conveyance feature site plans, inspection schedules, maintenance triggers and methods, and other information that specifies operations and maintenance activities.

Stormwater facilities and conveyance features on property (parcels or tax lots either privately or publicly owned) are the responsibility of the property owner(s). The property owner(s) must submit O&M information to the City for approval and record it with the appropriate County for all required stormwater management facilities, conveyance features and impervious area reduction techniques.

- If multiple properties share one onsite private stormwater system, property owner(s) for each property must record and file the O&M submittal. All properties and property owners that are served by the onsite stormwater system jointly own it and are equally responsible for its O&M.
- If a property served by an onsite private stormwater system is subsequently divided, a new O&M submittal must be approved at the time of BES review and recorded for each newly created parcel and/or tax lot that was previously part of the original parcel or tax lot.

Stormwater facilities in the public right-of-way or in public easements are the responsibility of the permittee until accepted by the City following completion of a 2-year warranty period at the conclusion of the public improvement process or Public Works Permit. The two-year warranty period begins at the time of signing the certificate of completion for the public works project and provides proper establishment before the City assumes ownership and/or maintenance of the

stormwater facility. During the warranty period, regular maintenance tasks must be performed; deferred maintenance may result in extension of the warranty period if City inspection determines that the facilities are not established as per the requirements in [Chapter 3](#).

For public easements or stormwater tracts, BES maintains the public stormwater facility following acceptance, and the property owners continue to maintain the tract itself and any associated features, such as access ways, additional landscaping, or fencing. Designation of maintenance responsibility will be determined in a maintenance agreement recorded at plat approval as per the approval of both BES and BDS.

A Public Works Permit Permittee may enter into an agreement with the Watershed Revegetation Program to maintain the vegetation in the future public stormwater facility during the warranty period, but this does not exempt the permittee from other O&M requirements. See [Section 3.2](#) for more information about establishment of public stormwater facilities.

O&M of a stormwater facility or conveyance feature is documented through an inspection and maintenance log. In general, the log must note all inspection dates, the components inspected, and any maintenance or repairs made. The logs must document deficiencies and corrective actions taken to keep structural and vegetative components in good working order. The City may accept work orders, invoices, or receipts in lieu of an inspection and maintenance log.

1.4.1 Exemptions from O&M Submittal Requirements

Single- or dual-family unattached residences are not required to provide an O&M submittal if a drywell or soakage trench is the only stormwater facility on the building or development permit.

For City of Portland or Port of Portland projects that involve building or other development permits, an O&M submittal will be reviewed by the City prior to permit issuance. The City and the Port are not required to record O&M submittals with the County for stormwater management facilities required by the City's SWMM.

1.4.2 Operations and Maintenance Enforcement

The City has the right to ensure site compliance with the recorded O&M submittal filed with the City. City Code sections 17.38.040 D, 17.38.043 and 17.38.045 authorize BES right of entry for inspections, the ability to issue a code violation, and the ability to take enforcement actions and levy civil penalties.

The [Maintenance Inspection Program](#) provides post-construction inspections of stormwater facilities on private property. The administrative rules governing inspections and enforcement are the Maintenance Inspection Program Administrative Rules ([ENB-4.31](#)) and the BES Enforcement Program Rules ([ENB-4.15](#)). In general, BES inspectors will strive to work with site owners and operators to ensure proper facility O&M. If technical assistance does not yield tangible O&M improvements, BES may take enforcement action. BES staff inspects sites to verify that the property owner is properly operating and maintaining stormwater management facilities. Upon completion of an inspection, the inspector will provide a report addressed to the property owner or designated responsible party that outlines any required corrective action, deadline to correct, and City notification (if needed).

Unauthorized encroachments into drainage reserves or failure to maintain drainageways, drainage reserves, or encroachments into drainage reserves as per the recorded operations and maintenance plan is a violation of Portland City Code 17.38. BES will respond to, investigate, and resolve complaints about drainageways, drainage reserves, or encroachment to drainage reserves.

1.4.3 Revisions to Recorded O&M Submittals

Property owners must consult with the [BES Maintenance Inspection Program](#) to determine if a permit and/or a new O&M submittal is required prior to making onsite stormwater system or stormwater management facility modifications. Stormwater system or individual stormwater facility modifications subject to City review and approval include changes to the discharge location, source of runoff, or structural or vegetated components.

The City may require property owners to record a new O&M submittal if the O&M submittal on file with BES is inaccurate or otherwise insufficient. The property owner must submit a draft O&M submittal to the City and receive approval prior to recording it with the County. A final recorded O&M submittal must be filed with BES.

Additionally, when applicable, updates to O&M submittals must meet City approval and approved submittals must be filed with BES. The City may require property owners to record updated O&M submittals, site maps, or facility details with the County and submit a recorded copy to BES.

Facility owners are encouraged to follow O&M maintenance activities in the current version of the SWMM.

1.5 Special Circumstances

Special circumstances on a proposed site may make it impractical to meet the stormwater management requirements to the standards specified in this chapter. BES manages a Special Circumstances process to review requests either to meet stormwater management requirements in alternative ways or to pay an Offsite Stormwater Management Fee in lieu of building a stormwater facility as part of the project.

BES uses collected Offsite Stormwater Management Fees to construct stormwater management facilities to meet system-specific needs. The Offsite Stormwater Management Fee is calculated based on the average construction costs for the City to install a stormwater management facility through retrofitting existing development. The methodology and the rate are published and adopted through BES's annual budget process and are listed with the current fiscal year's [Sewer and Drainage Rates and Charges](#). Requests submitted following permit issuance will be charged the Post-Permit Issuance Offsite Stormwater Management Fee.

The Special Circumstances request must demonstrate why a stormwater facility is not technically feasible. The Special Circumstances request must account for all of the development and stormwater runoff from the site, including any partial stormwater management or impervious area reduction techniques. Project designers should consider impervious area reduction techniques, such as ecoroofs, tree credit, and pervious pavement, before submitting a Special Circumstances request. If site conditions are appropriate, the use of impervious area reduction techniques can reduce the required size of or eliminate the need for a stormwater management facility.

Stormwater management within the site must be achieved to the maximum extent feasible, as approved by BES, before any facilities outside of the proposed site or payment of the Offsite Stormwater Management Fee will be allowed. The project designer may propose alternatives to meeting all or a portion of the stormwater management obligations in other ways, such as in the public-right-of-way or outside the geographic limits of the development proposal, improvement, or site (e.g. stormwater credit trading). A project designer can request to pay an Offsite Stormwater Management Fee instead of building a stormwater management facility for some or all of the stormwater management requirements for the project.

If BES approves a Special Circumstances request, the project designer must construct an appropriately sized facility outside of the proposed site or pay an Offsite

Stormwater Management Fee prior to BES review and approval of the proposed development proposal. The Offsite Stormwater Management Fee may be prorated to account for portions of the stormwater management requirements that were met. Tree credit or other impervious area mitigation measures can still be utilized even if use of the Offsite Stormwater Management Fee is approved. Tree credit will be subtracted from the unmanaged impervious area prior to calculation of the Offsite Stormwater Management Fee.

No exceptions to meeting the stormwater management requirements are allowed. Going through a land division, partition, or property line adjustment does not exempt a property from stormwater management requirements – small sites are still required to meet stormwater management requirements and the size of the lot itself is not an allowable reason to grant a Special Circumstances requested use of the Offsite Stormwater Management Fee. Similarly, not being able to fully infiltrate stormwater onsite does not exempt a site from meeting stormwater requirements for the entire site prior to offsite discharge.

The Special Circumstances decision is valid for two years but is nullified if the area of development or redevelopment or other project circumstances change.

If a Special Circumstances applicant disagrees with the issued Special Circumstances decision, the applicant has a right to request a modification to the decision via an Administrative Review as outlined in City Code 17.38. Following the decision of the Administrative Review Board, the applicant has the right to appeal to the Code Hearings Officer. See [Section 1.6](#) for more information about Administrative Reviews and Appeals.

1.5.1 Special Circumstances Submittal Requirements

The [Special Circumstances Form](#) is required to request consideration for special circumstances.

Special Circumstances are reviewed by the BES Systems Development supervisors and the BES Stormwater Management Manual Manager or designee. The BES Stormwater Management Manager or designee will issue a decision letter that outlines general findings, the decision, and any instructions or conditions that must be met prior to the next approval milestone. If the Offsite Stormwater Management Fee is approved, any tree credit, impervious area reduction measures, or other stormwater management credit will be pro-rated prior to calculation of the fee. The Offsite Stormwater Management Fee is calculated per square foot of unmanaged impervious area.

If BES approves a Special Circumstances request, the applicant must follow instructions in the decision letter. For example, construction of an offsite stormwater management facility or payment of the Offsite Stormwater Management Fee would need to be complete prior to permit issuance.

[How to prepare a Special Circumstances Application](#)

No application will be reviewed unless it is complete. A complete special circumstances application consists of the following elements:

- Completed [Special Circumstances Form](#).
- One set of plans (site plan and any necessary details).
- Special Circumstances Application Fee (if applicable).
- Supplemental information specific to the project request.

It is critical that information provided in the special circumstances application be clear, concise, accurate, and complete. Each special circumstances request must stand on its own merit and will be reviewed based on the specific conditions related to the project under consideration.

[Special Circumstances Form](#)

The [Special Circumstances Form](#) consists of the following sections:

- Project information, including development or improvement proposal number (permit, land use review, or project number), development proposal location, applicant information, owner information (if applicable).
- Special Circumstances request, including the request being made and the features of the project that make it a special circumstance. Indicate any existing approval criteria in the *Stormwater Management Manual* and if or how those approval criteria would be met.
- Stormwater management information, including explaining any proposed stormwater management facilities or other means of partially meeting the stormwater management requirements for the site. Summarize how stormwater will be managed and indicate the discharge location (infiltration, specific type stormwater system (storm sewer, specific water body, etc.), or combined sewer), and location of the proposed disposal point (street intersection, existing public infrastructure, etc.). The request must account for all of the impervious area and for the management of all stormwater runoff from the site. Stormwater management within the site must be

achieved to the maximum extent feasible, as approved by BES in all cases before any Special Circumstances requests will be considered.

Plans

One set of plans (in addition to any plans submitted for permit processing) must accompany the Special Circumstance application. Plans must show the total amount of impervious area being created and all existing and proposed stormwater management and conveyance facilities. They should provide sufficient information to detail the areas considered to be a special circumstance, as well as any areas that may be affected by or that may affect those circumstances. The plans submitted under the Special Circumstances application must match the plans submitted for the development proposal.

Application Fee

The fee for a Special Circumstances application associated with development proposals (land use or early assistance cases, Public Works Permit, or building permits) is \$100. The application fee can be submitted with the development proposal, paid in person on the first floor of the Development Services Center, 1900 SW 4th Ave., or mailed to the Bureau of Environmental Services, 1900 SW 4th Avenue, Suite 5000, Portland, Oregon, 97201, to the attention of the BES staff person assigned to reviewing the development proposal.

There is no fee for Special Circumstances requests made by public agencies through public improvement projects.

Supplemental Information

Submitting supplemental information (engineering analyses, infiltration test data, etc.) that will help clarify the request or make it easier to understand is encouraged. If relying on infiltration test results, geotechnical reports, or other technical information to support the Special Circumstances request, that information must be submitted along with the application.

How to submit a Special Circumstances Application

The Special Circumstances application must be submitted concurrently with the development proposal, building permit, land use and early assistance applications or public improvement for BES review. Applications will be screened for completeness within three business days of BES receipt or staff assignment. Inaccurate or incomplete applications will be returned and will cause a delay in considering the request.

For questions regarding the submittal process, call the BES Development Review Hotline at 503-823-7761.

Decisions

BES will issue Special Circumstances decisions within 21 calendar days of receiving a complete application (following a positive completeness check). Decisions will be recorded and emailed to the applicant. If the Offsite Management Fee is approved, the fee must be paid prior to the next BES review or approval milestone.

The Special Circumstances decision is valid for two years from the date of issuance. The decision is no longer valid if the area of development or redevelopment change, any changes to the site plan or offsite disposal location, or if any project circumstances change. The applicant would need to request a new Special Circumstances for review of the new circumstances.



**CITY OF PORTLAND
Stormwater
Management
Manual**

SPECIAL CIRCUMSTANCES APPLICATION FORM

Please fill this form out completely.

For assistance in completing it, consult with the Bureau of Environmental Services (BES) staff assigned to review your proposal or with BES staff in the Development Services Center. Refer to Section 1.5.1 of the 2016 Stormwater Management Manual for the complete Special Circumstances Submittal Requirements.

A complete Special Circumstances submittal consists of this form, the Special Circumstances Application Fee (if applicable), one (1) set of plans, and any supplemental information that support this Special Circumstances request. Plans should clearly indicated the new or redevelopment impervious area and proposed stormwater management.

(for staff use only)

Received by: _____

Date: _____

Deemed complete on: _____

I. PROJECT INFORMATION

SITE INFORMATION

Permit Number/LUR Case/Public Works Project Number: _____

Site ID (R number(s)): _____

Project Location/Site Street Address: _____

City/State/Zip: _____

Project Name *(if applicable)*: _____

Special Circumstances request location *(choose one)*: Private property Right of way

APPLICANT INFORMATION

Applicant Name: _____

Applicant Business Name: _____

Applicant Mailing Address: _____

City/State/Zip: _____

Applicant Phone Number: _____

Applicant Email Address: _____

OWNER INFORMATION *(if applicable)*

Owner Name: _____

Owner Mailing Address: _____

City/State/Zip: _____

Owner Email Address: _____

Describe development or improvement proposal *(one set of plans must be submitted that match this description)*:

SPECIAL CIRCUMSTANCES

APPLICATION FORM

2. SPECIAL CIRCUMSTANCES INFORMATION

Describe Special Circumstances request:

- Why are stormwater management facilities not technically feasible?
- Why should this proposal be considered given the stormwater management requirements of Chapter 1?

3. STORMWATER MANAGEMENT INFORMATION

Describe any existing and any proposed onsite stormwater management, including any impervious area mitigation measures (tree credit, pervious pavement, ecoroof) or stormwater management facilities that would provide partial onsite management.

Where will stormwater be conveyed and discharge to if this Special Circumstances is approved:

- Onsite Infiltration
- Storm-only system: Watershed or waterbody: _____
Location of storm-only sewer: _____
- Combined Sewer: Location of combined sewer: _____

Signature: _____ **Date:** _____

Print Name: _____ **I am the** Applicant Owner

1.6 Administrative Reviews and Appeals

The administrative review process allows applicants to request a review of staff interpretations of the City Code and of adopted policies and procedures that guide the review of development proposals. The purpose of an administrative review is for the bureau to determine if City Code and rule were applied consistently and correctly to the case at hand. The bureau will not grant exceptions to its requirements through the administrative review process or any other process. Applicants or their authorized agent may request administrative review of a BES decision related to the SWMM as described in this section.

A BES decision made under these rules is subject to administrative review by BES and appeal to the Code Hearings Officer unless stated in this section. For example, a person may request administrative review relating to interpretation of the stormwater management and conveyance requirements in the SWMM (e.g., applicability of stormwater management requirements, staff assessment of a site's stormwater management hierarchy level, flow conveyance requirements, or a permit denial), including decisions made under the special circumstances process. In addition, a person may request administrative review of the bureau's application of technical requirements, standards, and assumptions to the person's work that is subject to the SWMM. Decisions rendered regarding the approval of manufactured stormwater treatment devices are subject to administrative review but are not subject to appeal to the Code Hearing Officer.

BES will not grant administrative review of a Facial Challenge—as that term is defined in these rules—to a requirement in these rules or associated City Code, or to any technical standard. A requirement to submit a plan, report, test result, form, record, or other source of information necessary for BES staff to determine a party's compliance with technical standards is not subject to administrative review or appeal. A BES determination of a drainage reserve or drainageway channel and a BES determination on a request for encroachment into a drainage reserve or a drainageway channel are subject to administrative review but may not be appealed to the Code Hearings Officer.

Administrative reviews are conducted by bureau personnel. A person must submit a written request for administrative review within 20 business days of the date that BES issued the letter, notice, or decision. In the case of a BES decision that is issued through a City process administered by the Bureau of Development Services (BDS), e.g., through a land use review or building permit review, a person must submit a written request for administrative review of the BES decision within 20 business days of the date that the City issues the development decision (e.g., development permit or land use decision) that incorporates or is based on the underlying BES

decision, or within 20 business days of the date that BES transmits the BES decision to the person, whichever is sooner. In all cases, the requestor must provide all information known to the requestor that supports an assertion made in the written request for administrative review. The requestor must provide such information via graphic, written, or recorded communication, or in person at the administrative review meeting. BES will hold an administrative review meeting within 15 business days of receipt of the written request for administrative review unless BES determines in its reasonable discretion that a delay is justified. The requestor may provide detailed information in writing in lieu of attending the administrative review meeting. There is no fee charged for an administrative review. BES will use Portland City Code Chapter 17.38, the provisions of these rules and ENB-4.15, City records, and the testimony and documentation provided by the requestor to make a final determination on the issue that is the subject of the administrative review. BES will issue to the requestor a written final determination within 15 business days of the administrative review meeting unless BES determines that extenuating circumstances justify a reasonably longer time frame. The written final determination will provide information about the process for filing an appeal to the Code Hearings Officer if appeal to the Code Hearings Officer is an option.

Enforcement of the SWMM by BES is authorized under Portland City Code Chapter 17.38 and may involve the enforcement tools, civil penalties, City abatement, and cost recovery measures described in Portland City Code section 17.38.045. BES requires citizens to comply with the SWMM through a variety of avenues, including the development review and permitting processes, implementation of the BES Maintenance Inspection Program (under administrative rules ENB-4.31), and implementation of the BES Enforcement Program (under administrative rules ENB-4.15). When the City takes enforcement action under ENB-4.31, or ENB-4.15, then the provisions of those rules relating to administrative review and appeal also apply.

An administrative review is a required precursor to an appeal. Appeals are made to the Code Hearings Officer as per Portland City Code Title 22. A person may only appeal a decision that is subject to administrative review by BES.

Administrative Reviews and Appeals

Information about BES Administrative Reviews and Appeals, including timelines, submittal requirements, fees and forms, is found online at

<http://www.portlandoregon.gov/bes/68285>.

Chapter 2. Stormwater Facility and Conveyance Design

This chapter provides information needed to select and design stormwater management facilities and conveyance features that meet the requirements of Chapter 1. It includes the following sections:

2.1 Site Planning	2-4
2.1.1 Design Goals	2-4
2.1.2 Steps in the Design Process	2-6
2.2 Sizing Methodologies	2-18
2.2.1 Simplified Approach	2-21
2.2.2 Presumptive Approach	2-22
2.2.3 Performance Approach	2-25
2.3 Stormwater Facility and Conveyance Design	2-29
2.3.1 Types of Stormwater Facilities and Conveyance Features	2-29
2.3.2 Stormwater Facility Configuration	2-30
2.3.3 Standard Landscape Requirements	2-36
2.3.4 Facility and Conveyance Design Criteria	2-41
2.3.4.1. Ecoroof	2-43
2.3.4.2. Pervious Pavement	2-49
2.3.4.3. Tree Credits	2-53
2.3.4.4. Downspout Extension	2-57
2.3.4.5. Rain Garden	2-60
2.3.4.6. Swales	2-64
2.3.4.7. Curb Extensions	2-70
2.3.4.8. Planters	2-79
2.3.4.9. Basins	2-85

2.3.4.10. Filter Strips	2-91
2.3.4.11. Grassy Swales.....	2-94
2.3.4.12. Ponds	2-99
2.3.4.13. Sand Filters.....	2-109
2.3.4.14. Soakage Trenches	2-112
2.3.4.15. Drywells.....	2-117
2.3.4.16. Sumps.....	2-122
2.3.4.17. Manufactured Stormwater Treatment Technologies.....	2-127
2.3.4.18. Rainwater Harvesting.....	2-129
2.3.4.19. Structural Detention Facilities	2-131
2.3.4.20. Drainageways and Drainage Reserves.....	2-136
2.3.4.21. Drainage Reserve Encroachments	2-140
2.3.4.22. Channel Encroachments	2-143
2.3.5 Typical Details	2-146
Private Simplified Approach Typical Details (SW-100's).....	2-147
Private Presumptive and Performance Typical Details (SW-200's)	2-157
Green Street Typical Details (SW-300's).....	2-175
2.3.6 Infiltration and Soil Requirements.....	2-212
Depth to Groundwater Investigation.....	2-212
Infiltration Testing.....	2-218
Blended Soil Specification for Vegetated Stormwater Systems	2-229
2.4 Submittal Requirements	2-230
2.4.1 Landscape Submittal Requirements	2-230
Tree Credit Worksheet.....	2-243
2.4.2 Land Use Submittal Requirements	2-245
2.4.3 Simplified Approach Submittal Requirements	2-248
Simplified Approach Form	2-252
2.4.4 Presumptive Approach Submittal Requirements	2-254
2.4.5 Performance Approach Submittal Requirements	2-255

2.4.6 Stormwater Report Submittal Requirements.....	2-257
2.4.7 Drainage Reserve and Encroachment Submittal Requirements	2-260
2.4.8 Manufactured Stormwater Treatment Technology Submittal Requirements.....	2-265

2.1 Site Planning

As presented in [Chapter 1](#), the City of Portland requires stormwater to be managed onsite to the maximum extent feasible before it is discharged to an offsite disposal location. This is achieved by limiting impervious area and by directing stormwater to facilities designed to manage stormwater.

Successful design of stormwater facilities and conveyance features requires careful planning. This section introduces several overarching goals for integrating stormwater requirements into a comprehensive site plan and outlines the overall process for creating a stormwater management plan. This section provides guidance and recommended steps in preparing a stormwater plan that can meet City requirements and standards. Following the guidance in this section will help project designers meet the sizing requirements in [Section 2.2](#), the design standards in [Section 2.3](#), and the submittal requirements in [Section 2.4](#).

2.1.1 Design Goals

The following goals provide guidance for incorporating stormwater management facilities into an integrated site design.

Goal 1: Create an Informed Project Team

Early in the design process, it is critical to establish a clear understanding of the City of Portland's stormwater requirements with all members of the project team. With Portland's emphasis on infiltration and vegetated facilities, members of the design team may include the developer or owner, their representatives, civil engineers, geotechnical engineers, arborists, landscape architects, architects, geologists and planners. Licensed design professionals should develop the stormwater management plan or oversee its development. On teams where there is more than one design professional making stormwater management decisions, clear roles and responsibilities should be established to ensure efficient communication and design development.

Stormwater management can greatly impact project review and/or permitting as well as the project schedule and budget; therefore, it is important to anticipate potential issues and encourage early collaboration across all disciplines. Project team members should be prepared to strategize and integrate solutions that reduce impervious area, limit stormwater discharge, and protect and improve water quality.

Goal 2: Maximize Permeability, Minimize Offsite Discharge

Creating a site design with less impervious area reduces the stormwater volumes and flow rates, which can ultimately result in smaller stormwater management facilities and lessen downstream impacts. Options include clustering the development to limit the building footprint, as well as impervious area reduction techniques (see [Section 2.3.1](#) for guidelines and specifications). Maximizing permeability at every opportunity requires the integration of many decisions at all levels of the project, from site planning to materials selection; these decisions should be made with stormwater management in mind.

Goal 3: Use Stormwater as a Design Element

Unlike piped systems that hide water beneath the surface and work independently of site topography, infiltration systems can work with natural landforms and land uses to become a major site design element. When stormwater management is considered during the conceptual design phase, the infiltration and drainage system can suggest building footprints and circulation routes. In this way, the drainage pattern helps generate the urban form, creating a more aesthetically pleasing relationship to the natural features of the site.

The drainage system can be integrated into development plans to provide multiple project benefits:

- Improve site aesthetics.
- Provide recreational opportunities.
- Maximize land values.
- Improve project marketability.
- Help meet landscape and screening requirements.
- Provide wildlife habitat.
- Provide environmental education for employees, visitors, and the public.

Fencing or hiding stormwater facilities out of view not only precludes the opportunity to create an aesthetically pleasing site design, but also sends the message that stormwater is an attractive nuisance. While there are legitimate concerns for safety and liability, these concerns can usually be resolved with careful design consideration, such as specifying shallow facility depths with gentle side slopes.

Plans that integrate stormwater facilities with the other development objectives can yield a series of small landscaped areas that meet other project objectives, rather

than creating one large, fenced pond at the end of the conveyance system. Stormwater facilities, such as ecoroofs, swales, planters, and basins, can be landscaped with plants that are attractive.

2.1.2 Steps in the Design Process

Once the project goals and objectives are established and the concept is complete, the following steps are recommended for designing a stormwater management system. Depending on the type of development or improvement proposed, a combination of the following steps may be required. A detailed explanation of each step is provided on the following pages.

STEPS IN THE DESIGN AND PERMIT PROCESS

1. Evaluate the Site.
2. Confirm Current Requirements.
3. Characterize Site Drainage Area, Runoff, and Hierarchy.
4. Develop a Conceptual Design.
5. Develop Landscape Plan.
6. Complete Stormwater Management Plan.
7. Prepare Operation and Maintenance Plan.
8. Submit Final Plans and Obtain Permits.
9. Construct and Inspect.

For development initiated projects (land use, early assistance, public works permitting, building permits, or other development-related permitting), a number of these steps are required in order to demonstrate compliance with City approval criteria. Steps 1 through 6 must be completed to ensure that Bureau of Environmental Services (BES) approval criteria, early assistance, and land use review requirements can be met through the Bureau of Development Services (BDS) processes. Steps 1 through 9 must be completed to ensure that BES approval criteria and requirements can be met through the BDS process for building permit (or other private development permit) review, including private stormwater facility or conveyance feature construction inspection. Steps 1 through 9 must be completed to ensure that BES approval criteria can be met through the Public Works Permit process for development-related proposals in the public right-of-way, including any required public works inspections.

If an underground injection control (UIC) facility is proposed, Steps 1 through 5 also allow the project designer to prepare for Oregon Department of Environmental Quality (DEQ) rule authorization or Water Pollution Control Facility permit application.

Projects by public agencies will complete all steps throughout the design and construction process for public improvements.

Note: Every project is different, and it is not within the scope of this manual to specify what permits or reviews are required. For development related projects, applicants are encouraged to visit the Bureau of Development Services' Development Services Center to identify comprehensive project review and permit requirements.

Development initiated stormwater improvements

For more information about the City of Portland's development review and permit processes, refer to <http://www.portlandoregon.gov/bds>.

For more information about the City of Portland's public works permit process, refer to <http://www.portlandoregon.gov/publicworks>.

Step 1: Evaluate the Site

The first step in designing a stormwater management system, including stormwater management facilities and conveyance features, is to document and evaluate existing site conditions.

PortlandMaps

A variety of site-specific information is available online through www.PortlandMaps.com. The completeness of the records available will vary, but may include historic plumbing permits, zoning information, historic or recent permit information, and proximity of sewer and stormwater infrastructure to development projects.

Identify existing site features that could be protected or incorporated into the site. Identify existing natural or manmade drainage features, including open channels, ditches, ponds, depressions, wetlands, fish bearing and non-fish bearing streams, lakes, and rivers. Include riparian areas and other significant vegetation, including mature trees. Identify limits of development and access, as related to disturbance of soils, vegetation, and water quality sensitive areas.

Delineate tree canopy on and around the site as per Title 11. Where and when desirable or required by tree preservation and mitigation standards, conserve or plan to supplement existing tree canopy, especially conifers.

Identify surface and groundwater features that will affect the facility design, including size of drainage area/basin, topography and slopes, geologic formations, and seasonal groundwater levels. Document the distance to drinking water wells, wellhead protection areas, and other groundwater areas of concern.

Identify existing utilities, including all public and private storm, sanitary, and combined sewers, as well as water lines. Identify existing conveyance features, including culverts and outfalls. Identify drainage flows across the property from upland areas to downstream receiving waters. Existing and proposed utility placement should be addressed during design; existing utilities may need to be relocated. Potholing to verify depth, cover and location may be required. In the public right-of-way, utilities should be generally located outside or underneath any stormwater facilities. If existing or proposed utilities must cross perpendicularly through the stormwater facility, the utility location should avoid areas of plant growth (soil, vegetation). If existing or proposed utilities must be parallel to the facility, the utility location should have sufficient clearance outside of the facility walls or street curbs and gutters. Approved placement of utilities and stormwater facilities in the public right-of-way will be coordinated during the Public Works Permit or Street Opening Permit process under PBOT authority.

Identify potential drainageways and associated drainage reserves. BES' determination of an onsite drainageway and placement of a drainage reserve does not depend on water being present, only on factors that demonstrate the presence of water during previous wet seasons. Placement of a drainage reserve may be based in any combination of these factors; not all the factors must be present. In making the determination, BES staff will evaluate the following factors:

- Topography.
- Existing and proposed infrastructure (e.g., culverts, right-of-way ditches, outfalls).
- Soil type and erosion/incision.
- Channel substrate.
- Evidence of drift lines, waterborne sediment deposits, or sorting.
- Soil saturation within 18 inches of the surface.

- Vegetation characteristic of riparian, streambank, or wetland habitats.
- Visual topographic or vegetative connection to nearby wetlands, streams, seeps/springs, and sensitive natural areas.
- Maps, photographs, or historical permit records.
- Identification of any municipally owned stormwater controls structures or management facilities along the drainageway or at its inlet.
- Visible flowing or ponding water.
- Volume and velocity of existing drainage on, upstream of, and downstream of the site (including groundwater flows).

See [Section 1.3.4](#) for requirements for drainage reserve protection. In addition to drainage reserve requirements, BDS implements Title 24.50 requirements which may require identification of floodplain width.

Private systems may need to be decommissioned and public service provided. Locate existing sumps, drywells, cesspools, and septic systems. Contact BDS Records & Resources at 503-823-7660 for plumbing as-builts and access to building plans on private property. Contact BES System Development Assistance at 503-823-7761 for as-builts of public infrastructure in the right-of-way.

Consider land use, traffic area and circulation, drainage patterns and routes of conveyance, and other water quality concerns with respect to contributing drainage basins. Plan to keep stormwater management facilities a safe distance from operations that involve hazardous materials or solid waste.

Research existing soil conditions, particularly infiltration potential and whether contamination exists onsite. Determine hydrologic soil group, soil drainage class, and potential for erosion. (Refer to site evaluation maps in [Appendix C](#).) Examine boring and/or infiltration test results from nearby drywells or sumps to support the feasibility of infiltration.

Step 2: Confirm Current Requirements

This is the appropriate time to confirm all required City of Portland reviews and permits, as well as all other permit requirements—e.g., National Pollutant Discharge Elimination System construction site and discharge permits, DEQ UIC authorization, and other applicable requirements.

In addition to confirming stormwater management requirements, identify:

- Setbacks (see Table 2-1 and Figure 2-1).
- Easements.
- Drainage reserve requirements and encroachment requirements and other protected areas.
- Presence of any federally listed threatened or endangered species.
- Cut and fill quantities.
- Other site restrictions by consulting all applicable state and federal standards and requirements.

Other site restrictions include, but are not limited to, environmental zones, wellhead protection areas, greenway overlays, plan districts, seep/spring or other environmental tracts, floodplain development restrictions and requirements, tree conservation and tree root protection areas, landscape and/or screening requirements, and all other zoning or density requirements.

Identify any contaminated media, current or historical site activities that may impact stormwater facility design, or other site uses that may trigger source control requirements as provided in the City's [Source Control Manual](#).

Collect and confirm existing reports, tests, or studies required for site development—e.g., Phase I and Phase II environmental site assessments and geotechnical reports.

If the site conditions and/or the development proposal are complex, contact BDS to initiate an early assistance meeting or pre-application conference with City staff to discuss conceptual site plan ideas. Certain land use review types may require a Pre-Application Conference. Contact BDS or the BES land use section for assistance. Contact the Stormwater Early Assistance Team at 503-823-7761 for more information.

STORMWATER FACILITY SETBACKS

Setbacks for private stormwater facilities are derived from the State of Oregon plumbing and building code and represent best practices for ensuring safety of nearby structures or features. BES will enforce these setbacks unless an alternative is approved through BDS plumbing code appeal.

Setbacks are measured from the center of a drywell or from the outside edge of a surface stormwater facility to the adjacent boundary, structure, or facility (see Figure 2-1). All setback distances provided are minimums that can be increased at the discretion of City of Portland staff. Under typical conditions, setbacks assume that the stormwater facility is either level to or at a lower elevation than the finished floor elevation of any nearby structures. If an applicant proposes to encroach in a setback, the applicant must provide a signed and stamped geotechnical report that demonstrates that the proposal will meet the intent of the building and/or plumbing code requirements as part of an approved plumbing code appeal. An alternative facility design may be required to meet conditions of appeal approval.

Plumbing Code Appeals

Information about BDS plumbing code appeals can be found online at www.portlandoregon.gov/bds. To submit a plumbing code appeal, please check the [BDS website](#) for instructions or contact the appeals secretary at 503-823-7335.

Table 2-1. Summary of Stormwater Facility Setbacks

Type of Stormwater Facility	Setback from	Distance in Feet
Permeable pavers, pervious asphalt, or pervious concrete.	Property line or foundation. A liner may be required where located within 5 feet of infrastructure.	0
Lined facilities	Foundation	0
Lined facilities less than 30 inches above lowest adjacent grade	Property Line	0
All infiltration facilities	Property Line	5
All infiltration facilities	Any foundation	10
All infiltration facilities	Upslope from any drainfield	100
Swales and basins	Slopes 10% or greater	100
Trenches and drywells	Slopes 20% or greater	100
All infiltration facilities require geotechnical report and engineering	Slopes 20% or greater	<100
UIC	Slope greater than 10' high & steeper than 2h:1v	200
UIC	Drinking water well	500 (or 2-yr time travel)

Stormwater facilities may have typical setbacks. See facility-specific setback information in [Section 2.3.4](#).

Figure 2-1. How to Measure Stormwater Facility Setbacks

VEGETATED FACILITY

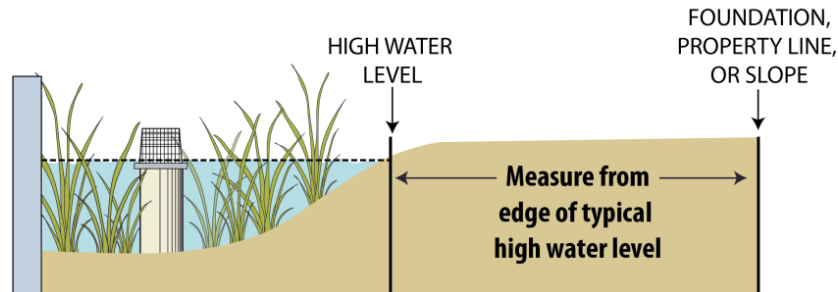

SUMP OR DRYWELL

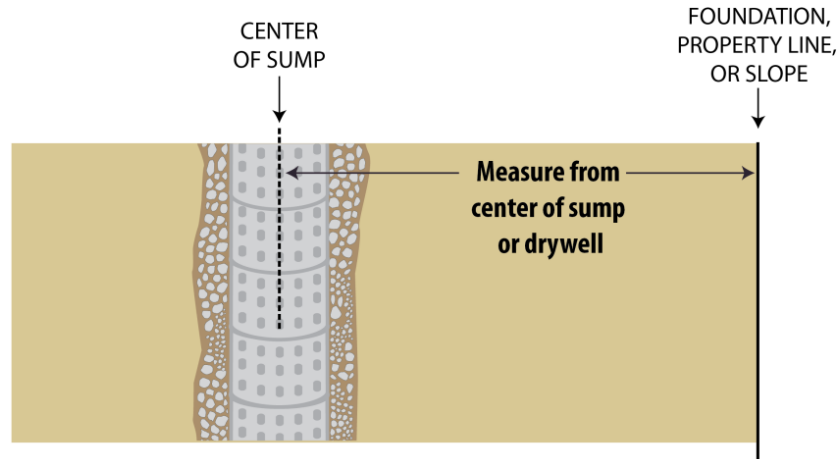

SUBSURFACE FACILITY

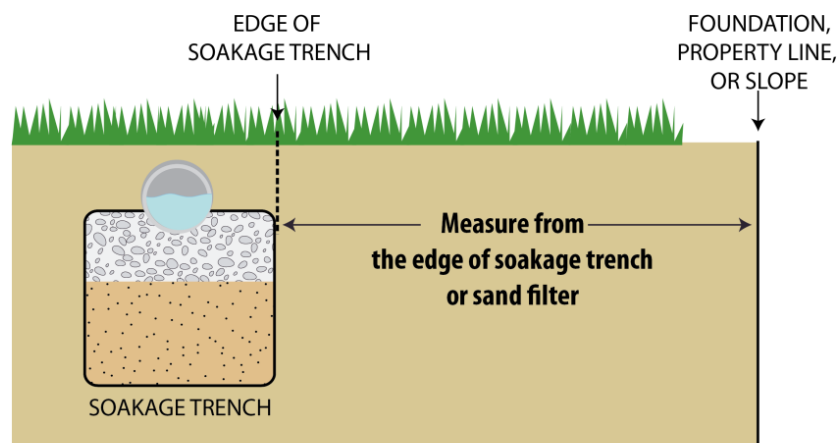

City of Portland Environmental Services ES 1604

Step 3: Characterize Site Drainage Area, Runoff, and Hierarchy

The third step involves evaluating the characteristics of the stormwater created by the proposed development or redevelopment.

Determine if the project will use the Simplified, Presumptive, or Performance Approach (see [Section 2.2](#) for a complete description of each) to size the stormwater management facilities. This is important because it establishes the type and number of infiltration tests that will be required. Begin to gather the information needed for the stormwater management submittals (see [Section 2.4](#) for submittal requirements.)

Conduct soil infiltration testing, as specified in [Section 2.3.6](#). Infiltration testing is also discussed in [Section 2.2](#).

Determine where stormwater will be discharged and what hierarchy level will be used.

Formulate how the stormwater management plan will meet the system-specific requirements of this manual, including infiltration and discharge, pollution reduction, flow control, and conveyance.

Work with BES staff to determine what upstream and downstream cumulative activities will impact the proposed project.

Work with BES staff to determine if the capacity of the downstream receiving system (natural or manmade) must be characterized.

If necessary, plan to safely route upstream flows across the site both during and after construction.

Determine if additional drainageway protection is necessary beyond the standard drainage reserve requirements. Determine if a drainage reserve encroachment would be required or could be avoided with careful site planning. See [Section 1.3.4](#) for drainage reserve requirements and [Section 2.3.4](#) for Drainageways, Drainage Reserves, and Encroachments design information.

Develop preliminary calculations that estimate how much stormwater will be created, how much can be infiltrated onsite, and how much, if any, will be discharged offsite.

Step 4: Develop a Conceptual Design

This step includes stormwater facility selection and preliminary sizing.

Select the appropriate facility type, location, and size for each proposed facility (see [Section 2.2](#)) detail specifications, especially minimum and maximum dimensions and setback requirements.

Develop a preliminary site grading plan. The grading plan should avoid impacts to drainageways and floodplains. It is essential for impervious surfaces to be graded to drain toward the stormwater facilities. The facilities must also be depressed to allow sheet flow into the area. Clearly supplement the grading plan with appropriate cross-sections and detailed drawings.

Some situations, such as steep slopes and high sediment loads, may limit facility options. Steep slopes will typically require more complex engineering. Plan to implement onsite erosion and sediment controls to reduce the amount of sediment getting into the stormwater or drainageways. Excessive sedimentation can significantly degrade water quality, impact fish and wildlife habitat, and damage a facility and require costly repairs. Pretreatment may be necessary to protect vegetated facilities. If a facility will be used for erosion control during construction, it must be constructed before general grading occurs and rehabilitated after construction.

Determine if hydrologic and hydraulic models specified in the City's [Sewer and Drainage Facilities Design Manual](#) are necessary to size public conveyance facilities. Correlate calculations between the conveyance infrastructure and the stormwater facility sizing.

Develop preliminary design calculations that demonstrate how the proposed plan will meet the pollution reduction, flow control, and infiltration and discharge requirements, including which category of the stormwater hierarchy ([Section 1.3.1](#)) the project will achieve. If a land use review or early assistance is required, the conceptual plan will be reviewed by BES.

Step 5: Develop a Landscape Plan

Once the preliminary sizing is complete, attention to the proposed soils and vegetation is necessary. See [Section 2.4.1](#) for landscape submittal guidelines, plant lists and specifications. See [Section 2.3.6](#) for soil specifications.

At this step, it is appropriate to consult with a qualified landscape professional. Proper soil and plant selection is critical to the success of a facility and must not be left unspecified.

Stormwater management facilities should be integrated with the other project landscape areas. Select plant species and develop a planting plan. Consider the use of native plants where appropriate. Urban conditions may require hardier species.

Native plants are required in drainageways for any proposed encroachments. Improvements to drainageways or drainage reserves should be phased to protect existing vegetation and support new vegetation.

Schedule plantings so they are well established before concentrated flows are routed to a facility. If possible, plan to wait 3 to 6 months before routing water into a facility. If this is not possible, establish approved erosion control measures before routing stormwater to a facility.

Step 6: Complete a Stormwater Management Plan

Complete final plans and any required submittal items. See [Section 2.2](#) for a more complete description of requirements and [Section 2.4](#) for submittal requirements.

Plans and specifications must be prepared or closely supervised by a certified design professional licensed in the State of Oregon.

Confirm that all design criteria are met. Confirm that volume storage within a facility is adequate. Complete grading plans and construction documents, including inlet and outlet locations, elevations, and sizes. Ensure that landscape construction and erosion control techniques are well described. Ensure adequate maintenance access to all stormwater facilities.

Step 7: Prepare an Operations and Maintenance Plan

See [Chapter 3](#) for operations and maintenance (O&M) submittal requirements. Since site plans may change during review, a draft O&M Form and Plan should be submitted with site plans. A final O&M Form and Plan will be required prior to permit issuance.

Outline the scope of activities, schedule, and responsible parties for inspecting and maintaining the stormwater management system, including stormwater facilities and related stormwater conveyance features, both during the maintenance warranty period (if applicable) and over the long term. Vegetation management, inlet clearing, weed control, sediment removal, trash and debris removal, and seasonal irrigation are some of the primary maintenance activities to be addressed.

Facilities that will come into the City's ownership and operation are subject to specific policies and guidance (see [Section 3.2](#)).

Step 8: Submit Final Plans and Obtain Permits

Development proposals will submit all final plans and drawings to the City of Portland for review, final approval, and permitting of the project. Various permits may be required including, but not limited to, a public works permit for construction in the right-of-way, a site development permit, a tree permit, or a plumbing permit. Provide additional information to City staff reviewing the application, as requested, to expedite the review process. Once permits are approved and issued, call for locates and begin construction.

Public improvements designed and constructed by public agencies will be reviewed by BES. Depending on the scope of the project, Street Opening Permits from the Portland Bureau of Transportation may be required.

Step 9: Construct and Inspect

The construction and inspection processes vary for private and public stormwater improvements.

Public Improvements. Once design plans for public facilities are approved and permitted, the Public Works Permit applicant (Permittee) must schedule a preconstruction meeting with all relevant city construction inspection teams to coordinate and evaluate all stormwater components of the project before construction. Initial inspection coordination is established at this meeting. Inspections throughout the project are coordinated by the City inspector and the contractor or general manager. Meetings with design engineers, contractors, and construction review teams are integral to ensuring that all stormwater facilities are constructed according to the development goals, project plans, and current design specifications.

Private Improvements. BES performs construction inspections on private property within the development permitting process. The number, type, and sequencing of inspections required for proposed stormwater management systems will vary by a number of factors, including phasing of construction, type of development, and type and number of stormwater facilities. The inspection requirements will be determined during plan review. Vegetated stormwater facilities will usually require multiple inspections throughout the construction phase. Instructions on requesting inspections will be provided during plan review and permit issuance. The building permit applicant is encouraged to contact BES prior to building the facility to schedule preconstruction meetings or to verify inspection requirements. For more information on inspections of onsite stormwater management facilities, contact the BES Development Review Hotline at 503-823-7761.

2.2 Sizing Methodologies

This section presents three methodologies for sizing stormwater management facilities and conveyance features: the Simplified Approach, Presumptive Approach, and Performance Approach. Stormwater facilities and conveyance features sized with the Simplified and Presumptive approaches comply with the City's conveyance/capacity, flow control, and pollution reduction requirements (see [Section 1.3.7](#)). When the Performance Approach is used, it is up to the project designer to demonstrate that those requirements are met.

Project designers must select the Simplified, Presumptive or Performance approach to design stormwater facilities. Each approach has a unique plan review and approval process that establishes a review and approval track for the project. The final selection of a project design approach is subject to City approval. BES may require use of a different approach upon review of site conditions and technical constraints. For example, if a public improvement has specific project goals to meet approved system or facility plan outcomes, then regardless of size, the Performance Approach may be more appropriate. Similarly, if a development proposal at a small site would like to propose facilities that require analysis under the Presumptive Approach, the Presumptive Approach would be required. Use of some stormwater facility types require use of a specific design approach. A combination of approaches may be used for a single project, but the review and submittal requirements will be that of the more intensive approach.

For every project, the impervious area includes the total proposed impervious area, including, but not limited to, buildings and structures, streets and frontages, and driveway aprons and sidewalks.

The ***Simplified Approach*** is available for projects with less than 10,000 square feet (0.23 acre) total new or redeveloped impervious area on private property, including but not limited to roofs, patios, parking areas, and driveways. (See [Section 2.2.1](#) for more information.) This approach is most appropriate for small-scale residential development, typically with limited professional design services available. It is not allowed for use on large, complex projects or on projects that have multiple catchments that, when combined, exceed 10,000 square feet of new or redeveloped impervious area. It is not allowed on projects that include private streets, in the public right of way, or that would require a Public Works Permit.

The ***Presumptive Approach*** is required for sites larger than 10,000 square feet, such as medium- to large-scale residential and commercial projects on either private or

public property. The Presumptive Approach is required for private streets and for any project in the public right-of-way (see [Section 2.2.2](#) for more information). It can also be used to size facilities on smaller projects where the more detailed hydrologic calculations will allow the design professional to size a facility more accurately by taking tested infiltration rates and other more specific design factors into account. This approach requires design by a licensed engineer or qualified design professional.

The **Performance Approach** is required for projects with unique circumstances that require analysis that goes beyond the capabilities or specifications of the Simplified and Presumptive approaches. It may be used to address a range of circumstances, including, but not limited to:

- Size a performance-based facility (wetlands, ponds, grassy swales, sumps, drywells, etc. See Figure 2-5 for complete list.).
- Install an approved manufactured stormwater treatment technology that meets the City's pollution reduction requirements.
- Propose an alternate design methodology or facility specification.
- Address unique site conditions.

The Performance Approach requires design by a licensed engineer. Detailed engineering calculations must be provided as evidence of the proposed design's performance with respect to the stormwater requirements provided in [Section 2.2.3](#).

Figure 2-2 provides an overview of the three design approaches and their specific requirements.

Figure 2-2. Summary of Design Approaches

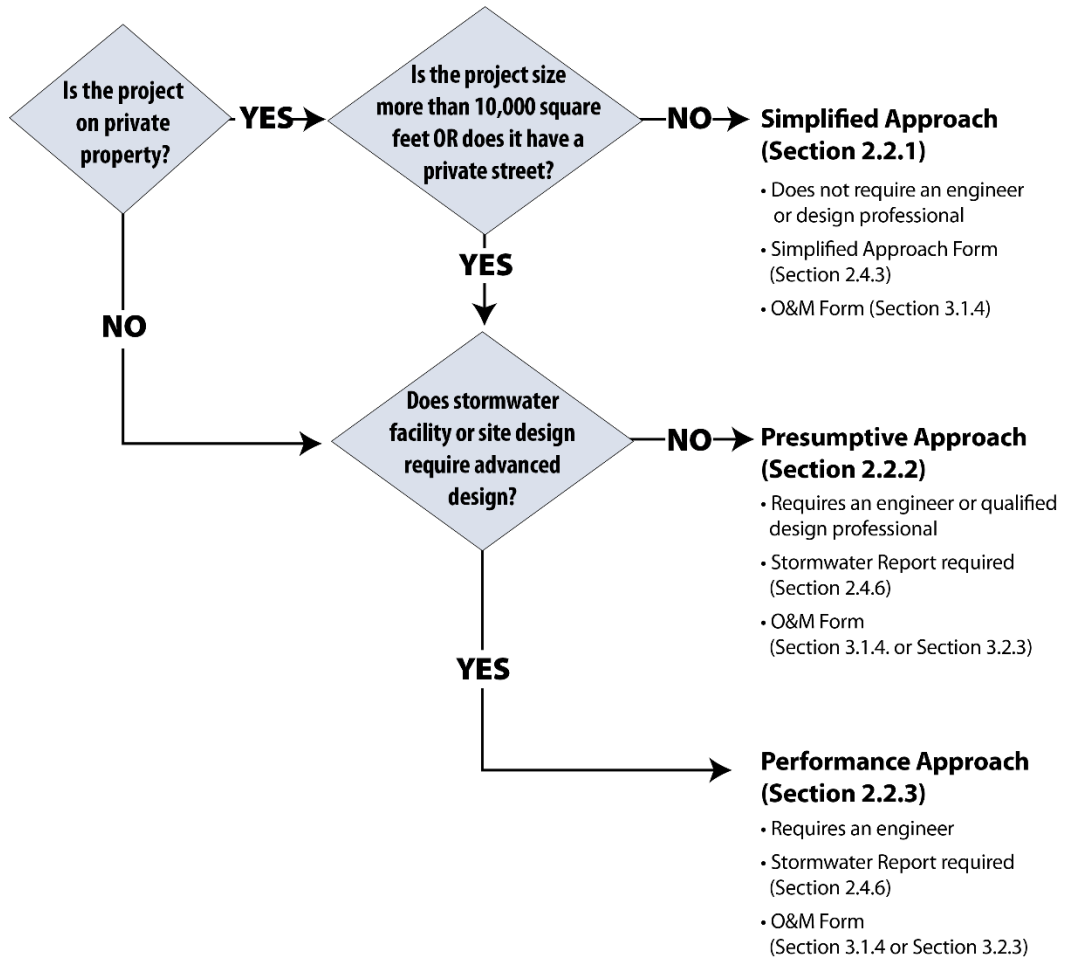

City of Portland Environmental Services ES 1604

Site design, site conditions, or facility choices may require use of a more advanced sizing methodology. Each sizing methodology has limitations and conditions that must be met.

2.2.1 Simplified Approach

Projects that use the Simplified Approach use a simple calculation to size stormwater facilities. To size stormwater facilities, the project designer quantifies the amount of new or redeveloped impervious area that is proposed (total surface area) and multiplies that area by a sizing factor that varies by facility type. The stormwater management facility sizing factors were developed with analysis based on the Santa Barbara Urban Hydrograph (SBUH) method. [Appendix A.1](#) provides information about the SBUH method, and [Appendix A.2](#) provides information about the Simplified Approach basis of sizing of stormwater management facilities. BES may require project designers to use a different approach upon review of site conditions and technical constraints.

With the Simplified Approach, vegetated surface facilities include:

- Rain gardens
- Swales
- Planters
- Basins
- Filter strips

Subsurface infiltration facilities include soakage trench and drywells. All of these facilities are designed to receive and manage stormwater runoff from adjacent impervious surfaces.

Impervious area reduction techniques (ecorooft, pervious pavement and tree credit) are also allowed under the Simplified Approach, but those techniques cannot receive stormwater runoff from adjacent impervious areas. Impervious area reduction techniques that are designed to receive runoff from other impervious areas must be designed under the Performance Approach (see [Section 2.2.3](#)).

All vegetated surface facilities and ecorooft designed with the Simplified Approach require an overflow to an approved discharge location. Total onsite infiltration is achieved when overflows are directed to a subsurface infiltration facility, including, but not limited to, drywells and soakage trenches.

Simplified Approach Infiltration Testing

The Simplified Approach requires at least one infiltration test to be conducted before selecting and sizing stormwater management facilities (see [Section 2.3.6](#) for the Simplified Approach Infiltration Test instructions and requirements). The Simplified Approach Submittal Requirements have instructions on how to submit the

infiltration testing information on the Simplified Approach Form (both found in Section 2.4.3).

BES does not require correction factors be applied to the tested infiltration rate when using the Simplified Approach Infiltration Test. A tested infiltration rate of 2 inches per hour or greater requires onsite infiltration. A tested infiltration rate of less than 2 inches per hour requires the use of a partial infiltration or lined facility with overflow to an approved discharge location. Exceptions apply depending on site conditions and the approved discharge location. See Section 2.3.2 for a description of facility configurations. If the tested infiltration rate is greater than 4 inches per hour, the designer should consider the use of the Presumptive Approach where well-draining soils can be factored in to more accurately design the stormwater facility.

Simplified Approach Submittal Requirements

As part of their building or other development-related permit application, applicants using the Simplified Approach must submit a completed Simplified Approach Form along with other documentation requirements listed in the Simplified Approach Submittal Requirements (Section 2.4.3). An Operations and Maintenance Form and the appropriate Operations and Maintenance Plan(s) must also be included. On sites with steep slopes or shallow groundwater, BES may require a geotechnical report in order to evaluate the suitability of the proposed facility and its location. BES staff may also require an encased falling head or a double-ring infiltrometer infiltration test under the Presumptive and Performance Infiltration Testing Requirements to verify that the Simplified Approach is appropriate.

2.2.2 Presumptive Approach

The Presumptive Approach allows the designer to factor in site-specific data to determine the size and configuration of the stormwater facility for swales, basins, and planters. It is approved for sites of any size. Like the Simplified Approach, the Presumptive Approach allows impervious area reduction techniques, vegetated surface facilities, and subsurface facilities. The Presumptive Approach also includes hybrid facilities. See Section 2.3 for a complete overview of facility types, configurations, and design requirements.

The Presumptive Approach Calculator (PAC) allows designers to size basins, swales, and planters with consideration of native infiltration rates and other unique site conditions of the project. See below for a discussion of the PAC.

Vegetated surface facilities available with the Presumptive Approach include swales, planters, and basins, all of which are designed to receive and manage stormwater

runoff from adjacent impervious surfaces. Under the Presumptive Approach, swales, planters, and basins can be designed as infiltration, partial infiltration, hybrid, or lined facilities.

Hybrid facilities can be designed under the Presumptive Approach. They combine the benefits of vegetated surface facilities with those of subsurface infiltration facilities to provide pollution reduction, flow control, and full or partial infiltration that meets specific stormwater hierarchy requirements (see [Section 2.3.2](#) for a complete description of hybrid facilities).

Presumptive Approach Infiltration Testing

The Presumptive Approach requires infiltration tests to be conducted before performing any design calculations for basins, swales, planters, and UICs. Three infiltration testing methods are approved to determine the design infiltration rate:

- Open pit falling head.
- Encased falling head.
- Double-ring infiltrometer.

A qualified professional must exercise judgment in the selection of the infiltration test method (see [Section 2.3.6](#) for the number and location of tests required). Depending on site conditions and the proposed facility location, the City may adjust the required number of tests. If the location and/or orientation of the proposed facility are revised during the design process, retesting will be required, unless otherwise approved by the City.

The Presumptive Approach requires in all cases that correction factors be applied to the tested infiltration rate to determine the design infiltration rate. See [Section 2.3.6](#) for the correction factors that apply.

For the Presumptive Approach, a tested infiltration rate of two inches per hour or greater requires onsite infiltration. A tested infiltration rate of less than two inches per hour allows the use of a partial infiltration or lined facility depending on site conditions. Exceptions apply depending on site conditions and the approved discharge location. See [Section 2.3.2](#) for a description of facility configurations.

Presumptive Approach Calculator (PAC)

The City developed a standardized sizing calculator for vegetated surface facilities, named the Presumptive Approach Calculator (PAC). The PAC allows design professionals to size stormwater facilities based on site-specific data, such as native soil infiltration rates and above and below ground storage capacity. The PAC will

calculate if the proposed project design meets the stormwater hierarchy category requirements for flow control and pollution reduction.

If the design professional proposes to deviate from the recommended ranges in the PAC, the proposal must be submitted under the Performance Approach. [Appendix A.4](#) includes the technical framework behind the PAC and includes allowed and recommended ranges for data entry fields.

Presumptive Approach Calculator

The Presumptive Approach Calculator is an online calculator accessed through Portland Online. The PAC requires design professionals to have a portlandoregon.gov account. The PAC allows design professionals to save projects to their account and share design information through import/export functionality.

The PAC can be accessed at www.portlandoregon.gov/bes/pac.

Presumptive or Performance Approach Required for Streets

The Presumptive Approach or Performance Approach is required for sizing vegetated stormwater facilities in the public right-of-way and private streets.

The open pit falling head infiltration test may be used for sizing street facilities, but depending on the development proposal and the existing site conditions, the City may require the double-ring infiltrometer test (see [Section 2.3.6](#) for infiltration test specification and the location of minimum number of tests required).

Trees, planted in accordance with the City of Portland Urban Forestry requirements, may be used as an impervious area reduction technique in the public right-of-way and on private streets. Refer to [Section 2.3.4](#) for more information.

Stormwater Management Typical Details are available specifically for public streets (see [Section 2.3.5](#)). These typical details are commonly referred to as “Green Street Details,” they are tailored to circumstances commonly found in the right-of-way. Vegetated stormwater facilities for streets are often affected by street design criteria and are subject to certain dimensional limitations. Green Street Details can also be used for private streets or private parking lots as appropriate.

Presumptive Approach Submittal Requirements

Design professionals using the Presumptive Approach must submit a Stormwater Management Report as part of their permit application along with other documentation requirements listed in the Presumptive Approach Submittal Requirements (see [Section 2.4.4](#) and [Section 2.4.6](#)). An Operations and Maintenance

Form and the appropriate Operations and Maintenance Plan(s) must also be included.

2.2.3 Performance Approach

Engineers or qualified design professionals using the Performance Approach must demonstrate how the proposed design meets the *Stormwater Management Manual's* stormwater management and conveyance requirements. Engineers or qualified design professionals who have developed stormwater management facilities or plans that do not meet the requirements of the Simplified Approach or Presumptive Approach as listed previously must submit plans under the Performance Approach. Performance Approach submittals may include impervious area reduction techniques, vegetated surface facilities and subsurface facilities that vary from the specified design requirements. Performance Approach designs will be reviewed by technical staff under the direction of the Chief Engineer or designee.

The Performance Approach may be used to:

- Size a performance-based facility (ponds, grassy swales, etc.).
- Propose an alternate design methodology or facility specification, such as conveying runoff from impervious area to ecoroofs or pervious pavement.
- Address unique site conditions.
- Use the Presumptive Approach Calculator using values outside of recommended ranges (see [Appendix A.4 PAC Technical Framework](#) for recommended and required ranges).
- Use a manufactured stormwater treatment technology approved by BES for meeting pollution reduction requirements.
- Apply a new or emerging design technology, such as manufactured stormwater treatment technologies not approved for use in the City of Portland.

Facilities must be designed using the hydrologic analysis methods below. If these hydrologic analysis methods are not used, BES must pre-approve the alternative method before the plans and calculations are submitted. Regardless of how the hydrologic calculations are performed, all hydrologic submittals must include data necessary to facilitate BES's review. The engineer or qualified design professional must demonstrate how the site-specific stormwater management and conveyance requirements will be met, as appropriate.

Hydrologic Analysis Method Resources

The Santa Barbara Urban Hydrograph (SBUH) method may be applied to small, medium, and large projects. It is a recommended method for completing the analysis necessary for designing flow control facilities when not using the Simplified Approach.

The Natural Resource Conservation Service “[Urban Hydrology for Small Watersheds](#)” (NRCS TR-55) method may be applied to small, medium, and large projects. This is also one of the recommended methods for completing hydrologic analyses necessary for designing flow control facilities when not using the Simplified Approach.

The US Army Corps of Engineers “[Hydrologic Modeling System](#)” (HEC-HMS) method may be used on medium and large projects.

The Environmental Protection Agency’s [Storm Water Management Model](#) (EPA-SWMM) method may be used on medium and large projects.

Infiltration and Discharge

If surface infiltration facilities such as swales, planters, or basins are proposed to meet infiltration requirements, the sizing methodology must rely on retaining the 10-year storm through a facility that can be calculated using SBUH, NRCS TR-55, HEC-1, or EPA-SWMM. The Rational Method must be used to design the infiltration flow rate for sumps in the public right-of-way.

Flow Control

BES will use the SBUH to check design calculations for flow control facilities. The design professional may also use NRCS TR-55, HEC-HMS, or SWMM to demonstrate compliance with flow control standards.

Pollution Reduction

The City will accept a design proposed for pollution reduction requirements if the engineers or qualified design professionals demonstrates the following:

- Facilities must perform at the required efficiency: 70 percent total suspended solids (TSS) removal from 90 percent of the average annual runoff (see [Section 1.3.4](#)) and is capable of reducing Total Maximum Daily Load (TMDL) pollutants of concern (if applicable). Documented performance is required and must include published data, with supporting cited research, demonstrating removal of target pollutants at required levels.

- For sites regulated under discharge permits, pollution reduction facilities that target a specific pollutant of concern will be considered as long as pollution reduction requirements for the entire site are also being met.
- Facilities can be efficiently maintained to perform at the required level. Public facilities should not require more costly maintenance than facilities designed using the Simplified or Presumptive approach.

Flow Rate-Based Facilities

With the exception of facilities sized using the Simplified and Presumptive approaches, BES will use the Rational Method, with rainfall intensities presented in [Section 1.3.4](#), to verify flow rates used to size rate-based pollution reduction facilities. Through a continuous simulation model using Portland rainfall data, BES has verified that these intensities treat 90 percent of the average annual runoff volume. The design professional may also use SBUH, NRCS TR-55, HEC-1, or SWMM to demonstrate treatment of 90 percent of the average annual runoff volume.

Flow Volume-Based Facilities

Volume-based pollution reduction facilities included in this manual (wet ponds and extended wet detention ponds) must use the predetermined volume of 0.83 inch over 24 hours with a volume of basin/volume of runoff ratio of 2 to be in compliance. Through a continuous simulation model using Portland rainfall data, BES has determined that this volume provides adequate detention time to treat 90 percent of the average annual runoff volume.

Combination Rate/Volume-Based Facilities

With the exception of facilities sized using the Simplified Approach, BES will use a software program based on the SBUH method, or a continuous simulation model with Portland rainfall data, to verify the sizing of flow rate-based pollution reduction facilities that also rely on a storage volume component. The design professional may also use NRCS TR-55, HEC-1, or SWMM to demonstrate treatment of 90 percent of the average annual runoff volume.

Conveyance

For public culverts, outfalls, storm-only sewers and other drainage facilities, refer to the City's [Sewer and Drainage Facilities Design Manual](#) for acceptable hydrologic analysis methods for stormwater conveyance in the public right-of-way.

Performance Approach Submittal Requirements

Under the Performance Approach, the engineers or qualified design professionals must demonstrate that the proposed management plan meets or exceeds all of the City of Portland's stormwater requirements. Engineers or qualified design

professionals using the Performance Approach must submit a Stormwater Management Report as part of their permit application, along with a complete site plan, construction drawings, and details. An Operations and Maintenance Form and an Operations and Maintenance Plan must also be included.

See [Section 2.4.5](#) and [Section 2.4.6](#) for complete information about the submittal requirements for the Performance Approach.

2.3 Stormwater Facility and Conveyance Design

This section provides detailed requirements, specifications, and details for designing the stormwater facilities and conveyance features included in this manual.

2.3.1 Types of Stormwater Facilities and Conveyance Features

Impervious Area Reduction Techniques

Ecoroofs, pervious pavement, and trees are impervious area reduction techniques that can affect which design approach is required and reduce the overall square footage of impervious area that requires stormwater management (see [Section 2.3.4](#) for facility requirements and specifications). For example, if a project designer has a project with 11,000 square feet of impervious area, and site conditions allow for 3,000 square feet of pervious pavement, the project designer can reduce the impervious area to 8,000 square feet and use the Simplified Approach, as long as all other requirements for the Simplified Approach are met. Ecoroofs, pervious pavement, and trees intercept rainfall directly and are not allowed to receive stormwater runoff from other areas.

Vegetated Stormwater Facilities (VSF)

Swales, planters, and basins can be used to meet the Simplified, Presumptive, or Performance approach. Sizing calculation requirements will depend on the size of impervious surface managed and the corresponding approach.

Downspout extension and rain gardens are vegetated facilities that can be used to meet the Simplified approach. They are particularly suited for residential development and retrofits.

Filter strips, grassy swales, and ponds are vegetated facilities that meet limited stormwater management requirements. Filter strips are allowed under the Simplified Approach for impervious area under 500 square feet. If filter strips are proposed for use with over 500 square feet of impervious area, the Performance Approach is required. Ponds and grassy swales are allowed only under the Performance Approach.

Subsurface Infiltration Facilities

Soakage trenches, drywells, and sumps can also be used in combination with impervious area reduction if vegetated surface facilities cannot manage all of the impervious area. Under certain circumstances, subsurface infiltration facilities may be allowed without vegetated surface facilities.

Other Facility Types

Non-vegetated and structural stormwater management facilities, such as rainwater harvesting and detention tanks, require review and approval under the Performance Approach.

Manufactured Stormwater Treatment Technologies

Manufactured Stormwater Treatment Technologies (MSTT) can be used to meet pollution reduction requirements when discharging to stormwater-only systems. Manufactured stormwater treatment technologies from the approved list must be used with the Performance Approach. Other manufactured stormwater treatment technologies that are not on the list may be used in specific applications but must be submitted to BES as a Performance Approach for site-specific review and approval. Depending on discharge location, flow control may also be required. The engineer or qualified design professional is responsible for ensuring that any approval conditions for the specific MSTT are met.

Stormwater Conveyance Features

Conveyance features include drainageways, culverts, and outfalls that are used to transport stormwater. Conveyance features safely move a certain amount of stormwater to, from, and through a site in ways that protect water quality. Stormwater is conveyed to rivers through public and private storm sewers and outfalls, from streams and drainageways that pass through private ownerships and receive runoff from public right-of-way. Adequate conveyance capacity is critical for minimizing upstream, downstream or site impacts. Drainage reserve requirements preserve the capacity of stormwater conveyance on private property.

2.3.2 Stormwater Facility Configuration

Stormwater management facilities can be vertically configured five ways (see Figure 2-3):

- Surface infiltration.
- Partial infiltration.
- Subsurface infiltration.
- Hybrid facilities (both surface and subsurface infiltration).
- Lined facilities (does not infiltrate).

Figure 2-3. Vertical Stormwater Facility Configurations

SURFACE INFILTRATION

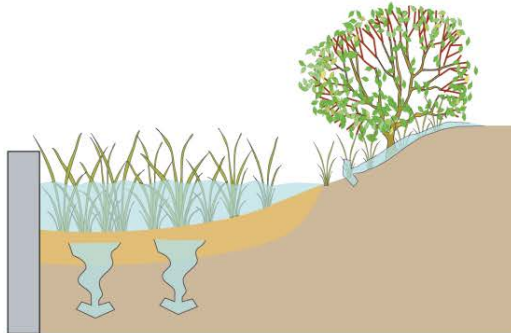

HYBRID

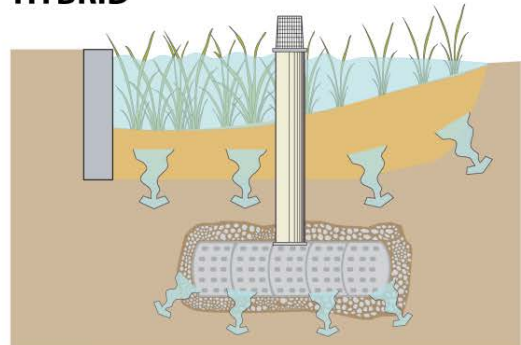

PARTIAL INFILTRATION

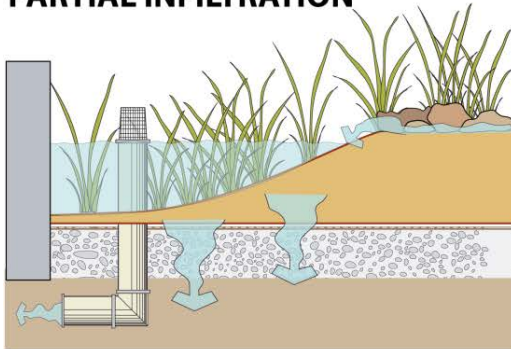

LINED

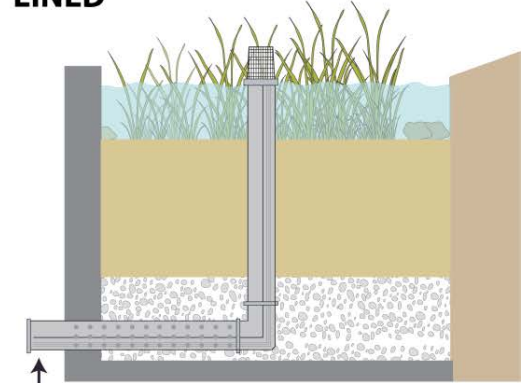

SUBSURFACE INFILTRATION (UIC)

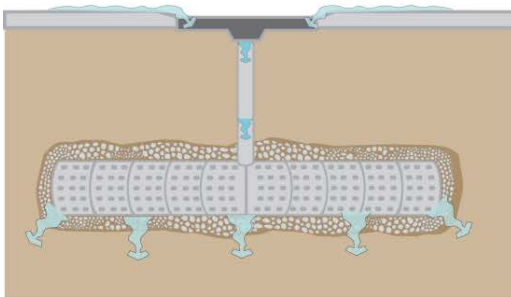

City of Portland Environmental Services ES 1604

Surface infiltration facilities achieve infiltration in the upper layer of the ground surface and can include facilities such as swales, planters, and basins. Infiltration facilities manage the 10-year design storm and require a tested infiltration rate of at least 2 inches per hour. Facilities that achieve total onsite infiltration do not require an offsite discharge location and therefore meet Category 1 or Category 2 requirements of the Stormwater Hierarchy (see [Section 1.3.1](#)).

Partial infiltration facilities are appropriate for sites with soils that drain less than 2 inches per hour. They achieve partial infiltration because they do not have a bottom or a liner but may include a surface overflow and an underdrain where flows in excess of the facility capacity are routed to an approved discharge location as specified in Category 3 or 4 of the Stormwater Hierarchy (see [Section 1.3.1](#)). Depending on site conditions, partial infiltration facilities may be used where complete infiltration is not achievable. A partial infiltration facility would be sized and designed as a lined facility, but would still achieve some infiltration.

Subsurface infiltration facilities achieve infiltration below the ground surface and include facilities such as sumps, drywells, and soakage trenches. Subsurface infiltration facilities are subject to DEQ's UIC regulations (see [Section 1.3.3](#)).

Hybrid facilities combine a vegetated infiltration facility with a subsurface infiltration facility. They achieve both surface infiltration and subsurface infiltration through bypassing flows greater than the water quality storm directly to a gravel layer below the facility growing medium or to a subsurface infiltration facility. By providing a direct connection to subsurface infiltration, the designer can take advantage of higher native infiltration rates, if they exist, or utilize the below-grade storage to reduce the size of the facility. Hybrid facilities are also subject to DEQ's UIC regulations (see [Section 1.3.3](#)).

The hybrid facility is a configuration type that is appropriate for sites with well-draining soil but with space limitations. They are not allowed on projects using the Simplified Approach sizing. Under the Simplified Approach, a surface facility can overflow to a subsurface facility, but the sizing methodology does not take the infiltration of the surface facility into account. Under the Presumptive or the Performance Approach, a hybrid facility can be designed to maximize infiltration at the surface and in the subsurface.

Lined facilities include an impervious or lined bottom and do not infiltrate. They are appropriate for sites that have restrictive site conditions including steep slopes, landslide risk, high groundwater, facilities located on structures, soil or groundwater contamination, and may also be appropriate next to structures or property lines to

protect foundations, basements, and adjacent properties. Lined facilities include a surface overflow and/or an underdrain in the gravel layer where treated flow is routed to an approved discharge location as specified in Category 3 or 4 of the Stormwater Hierarchy (see [Section 1.3.1](#)).

Shared facilities

Stormwater that is generated from impervious area on a property (privately or publicly owned) must be managed on the property, while stormwater generated from within the public right-of-way must be managed in the public right-of-way. Deviating from this horizontal configuration of stormwater management facilities is considered a **“shared” stormwater management facility**. “Shared” facilities, those that are designed to manage stormwater runoff from property and the public right-of-way, may be considered at the discretion of BES if the proposed facility meets stormwater and transportation system needs and if at least one of the following criteria is met:

- Public street improvements require the construction of a public stormwater management facility, and there is an opportunity for a private facility to accept public runoff that cannot be managed effectively in the public right-of-way.
- Private stormwater management facilities are not feasible to be constructed on private property, and there is sufficient area in the public right-of-way to construct a facility that can manage stormwater from both the street and the private property.

The property owner must share in the ongoing operations and maintenance costs and/or responsibility in proportion to the property’s stormwater contribution. Shared facilities in the public-right-of-way will require review and/or permits from the Portland Bureau of Transportation and require an O & M plan to be recorded on the deed of all participating properties.

Discharge configuration

Stormwater management facilities may be required to discharge offsite depending on the facility type and site conditions. The configuration of the overflow discharge may vary based on stormwater facility type, type of stormwater system discharging to, or site design (see Figure 2-4).

A piped overflow is typically set at an elevation above the growing medium and provides a safe overflow where flow exceeds the design capacity of the facility. Overflows are required for a variety of specific facility types when not designed for complete onsite infiltration or when infiltration requirements cannot be met (see

Section 2.3.5 for typical piped overflow configuration details). A piped overflow requires a connection to an approved discharge location. A [weep hole to a public street](#) curb (also referred to as a curb outlet) may be allowed with PBOT approval.

A passive overflow is typically set at an elevation above the surface of the growing medium, such as a notch in a planter wall to direct the overflow to an approved discharge location. In the right-of-way, this may be a notch in the curb directing overflow to the gutter.

A piped underdrain is typically set at an elevation below the growing medium (or rock storage, if used) to drain stormwater flows that pass through the growing medium and cannot be infiltrated onsite. A piped underdrain requires a connection to an approved discharge location.

An escape route is a requirement for all projects to delineate where flows will be routed to maintain public safety and prevent property damage in the event the facility fails or flows exceed the facility design capacity. Identifying an escape route is in addition to identifying an offsite discharge overflow method. Depending on site conditions, this may include an overflow structure or storage in a parking lot, street, or landscaping areas. Escape routes from stormwater facilities cannot be directly piped to public storm sewer or combined sewer systems. Project designers must describe where the flow will be routed on a basin site plan to illustrate where flood conditions or ponding is expected to occur. If an appropriate escape route cannot be identified, then the project designer will be required to design to at least the 100-year design storm.

Figure 2-4. Stormwater Facility Discharge Configurations

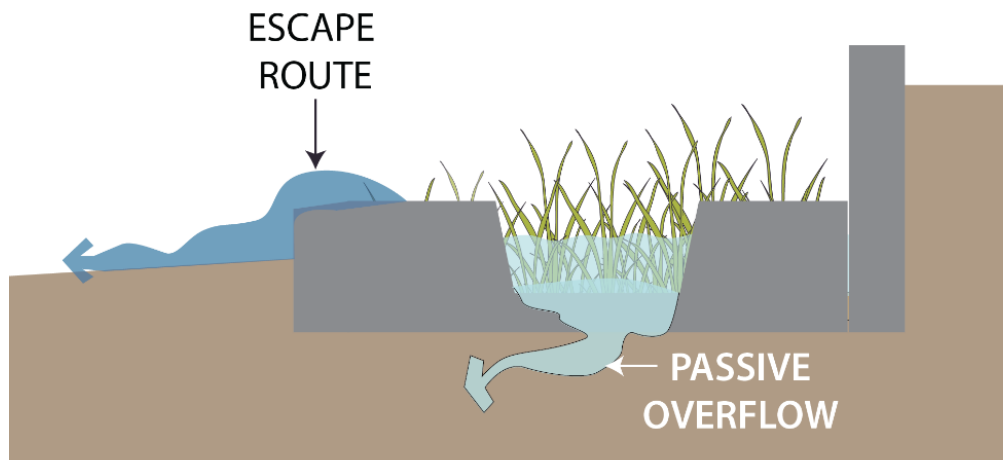
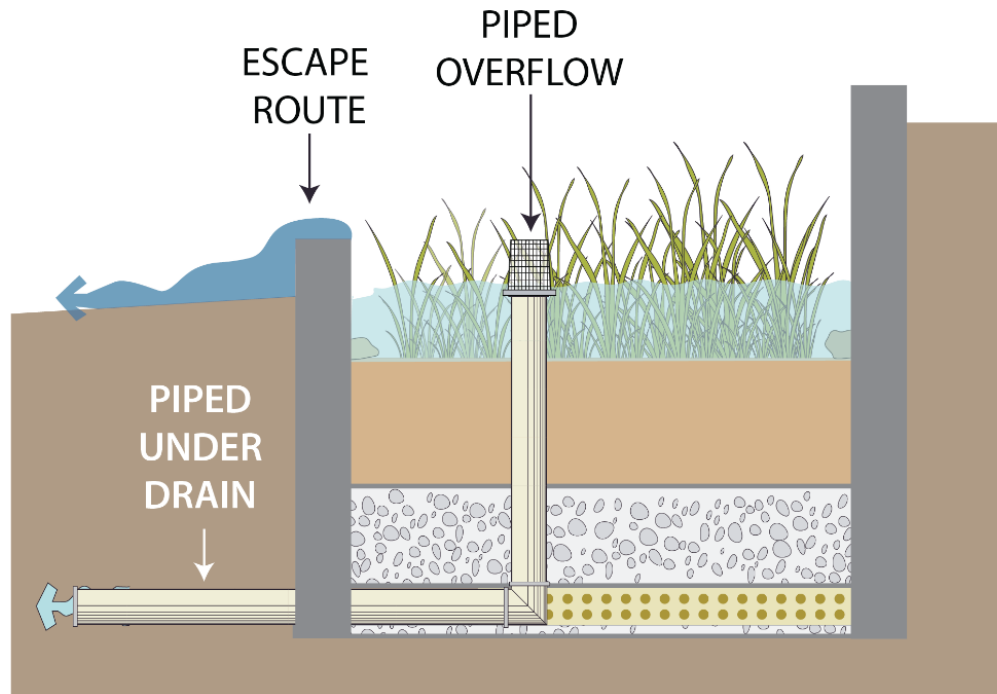

City of Portland Environmental Services ES 1604

2.3.3 Standard Landscape Requirements

This section addresses the landscape requirements that apply to the design and construction of all vegetated stormwater facilities, both private and public (see the individual facility descriptions in [Section 2.3.4](#) for facility-specific and private/public facilities requirements).

Site Preparation and Grading

Existing vegetation to be saved must be clearly marked and securely protected. If native plants are present, they should be salvaged and stored for replanting once construction is complete. Unwanted vegetation in the facility area should be removed during site preparation with equipment appropriate for the type of material and site conditions.

The location of all areas of future stormwater facilities should be clearly marked before site work begins. All stormwater facilities should be fenced or covered to protect them from damage or misuse during construction. Fencing is required around all infiltration facilities to prevent soil compaction during construction. The subgrade in proposed infiltration areas must not be compacted. At least 6 inches of native material must be maintained above the proposed bottom of the facility until construction is scheduled for the facility. No vehicular traffic, material storage, or heavy equipment is allowed within 10 feet of the infiltration facility area after site clearing and grading have been completed, except that needed to excavate, grade, and construct the facility. Lined facilities must be covered with plywood or other sheeting to prevent misuse, such as temporary storage of construction debris. No stormwater facility area should be used for dumping concrete or other construction waste, mixing grout, cleaning tools, or washing paint brushes.

Follow all tree protection requirements of [Title 11](#).

Location of all stockpiles must be indicated, including erosion protection measures per the [City's Erosion and Sediment Control Manual](#). The erosion and sediment control plan set should show the fencing layout for vegetation to be protected and the location of stormwater facilities.

Once the facility area is graded, all native subsoil must be scarified before installing the specified stormwater facility growing medium. No disturbance should occur within the drip line of existing trees. After scarifying, no other construction traffic should be allowed in the area, except for planting and related work. All construction and other debris must be removed before the growing medium is placed. Furthermore, the soil must not be exposed during wet weather conditions and must be covered with the growing medium within 1 day of being exposed.

Surface drainage must be prevented from entering the facility during construction until the facility is fully installed and the contributing catchment area is constructed. Proposed facility areas must be protected from sedimentation during construction. The contractor is responsible for protecting the facility from erosion before water is allowed to enter the facility. Appropriate erosion control measures, as required by the City's Erosion and Sediment Control Manual, must be used.

Access

The design must consider safe access for maintenance of the facility and of adjacent buildings or infrastructure. Stormwater facilities must be accessible for monitoring and maintenance. Paths, gates, and covers must be safe to access. Where structural surfaces are needed to support vehicles, access routes must be of sufficient width to allow vehicle passage and constructed of gravel or other permeable paving surfaces where possible. Public facilities must have access routes sufficient to be accessed by vehicle and must be located adjacent to the public right-of-way wherever feasible. If a facility is accessed only by the public right-of-way, plan for a safe parking space for maintenance vehicles, as well as traffic disruptions caused by maintenance activities.

Geosynthetic Liner and/or Waterproofing

Where infiltration is not safe or not allowed, stormwater facilities must be designed to be water-tight. A liner and corresponding attachment details or single-pour concrete may be required depending on the location. Consult a structural engineer if the facility may impact an adjacent foundation. Slow infiltration rates do not require liners.

Liners may also be used to protect structures or prevent infiltration immediately adjacent to roadways. Partial lining (half-liners or curtain liners) may be required depending on a number of factors. This would not be considered a "lined" facility configuration because it is not designed to be water-tight.

Pipes, Inlets, Outlets, and Storm Sewers

Pipe may be necessary for conveying stormwater from roofs and impervious surfaces to stormwater facilities, inside facilities for ensuring that water moves through, and from the facility to the approvable discharge location. See individual facility overviews and details for requirements, and any plumbing code as required.

Drain Layer

A drainage layer (sometimes referred to as rock storage or a rock gallery) may be required below the growing medium of a vegetated facility. The intent of this layer is to retain or detain and convey stormwater. See individual facility overviews and

details for requirements, as they are different depending on sizing approach and facility type.

Geotextile or separation lens (if required or approved)

Typically a separation layer is required between the drainage layer and the growing medium, usually a geotextile fabric or a gravel lens. This keeps the layers distinct and allow for good conveyance.

Anywhere a geotextile is used in a critical application, a geotechnical professional should specify it for that application.

Check dams

Check dams are required in some vegetated stormwater facilities to allow water to pool. Check dams can increase infiltration into the ground and help provide flow control prior to offsite discharge. They also slow flow to remove coarse sediment and prevent erosion. They must be constructed of durable, nontoxic materials such as rock, brick, concrete, rot resistant wood, or wood composite. Integrate these materials into the grading and install them perpendicular to the flow path of stormwater.

Growing Medium

Growing medium supports plants and micro-organisms that improve the function of stormwater facilities. Growing medium may include stormwater facility blended soil, blended topsoil, three-way mix, or native soils. See individual facility design criteria and details for requirements in private and public facilities.

Soil analysis for all growing media is required for all public facilities and may be required for private facilities. Soil analysis is not required for single-family residential sites. The source of growing medium must be provided.

Soil placement and planting should occur in conditions that do not result in over-compaction or erosion. Temperature, moisture levels, and handling can have a huge influence on the infiltration rate of a facility and on plant survivability.

Vegetation

Plants are critical to the performance of vegetated stormwater facilities and therefore must be selected for the appropriate soil, hydrologic, and site-specific conditions. The planting design must minimize the need for herbicides, fertilizers, pesticides, or soil amendments at any time before, during, and after construction and on a long-term basis. Plantings should also be designed to minimize the need for mowing, pruning, and irrigation.

For facilities located in environmental zones, drainageways or drainage reserves, or for BES-maintained facilities located outside of the public right-of-way, all plants within the facility area must be appropriate native species from the latest edition of the Portland Plant List. No plant species on the Nuisance Plants List or Required Eradication List contained in the Portland Plant List are allowed.

Structural components such as chain link fence, concrete bulkheads, outfalls, rip-rap, gabions, large steel grates, pipe, blank retaining walls, vault lids, and access roads should be screened from view by vegetation. The quantities and spacing of plant material required for each facility should provide sufficient screening. Attention should be paid to site conditions that may require adjustments to the planting plan, including the need for additional trees and shrubs. The intent of this requirement is not to dictate a specific solution such as a linear hedge. Designers are encouraged to integrate the facility landscaping with the screening objective. As a guide, landscape regulations for screens are provided in Landscaping Standards L2, L3, or L4 as specified in City Code Chapter 33.248.

See [Section 2.4.1](#) for the Landscape Submittal Requirements. See individual facility design criteria in [Section 2.3.4](#) and details for density and size requirements in private and public facilities. Refer to [Section 2.3.5](#) for planting templates appropriate for public and private streets.

Because portions of vegetated facilities areas are designed to accommodate inundation through the wet periods of the year, it is imperative for the designer to delineate the wet zone, Zone A, and develop a planting plan in accordance with the level of inundation/saturation. The moderate to dry Zone B surrounds Zone A and is likely to be inundated much less frequently than the lower portions of the facility. For the purposes of this manual in determining landscaping requirements, the delineation between Zone A and Zone B must be the elevation of either the outlet elevation or the top of the check dam, whichever is lower. Planting plans must be specific to the designated zones.

Depending on when stormwater will be routed to the facility, planting should preferably occur in the dormant season. For best results, planting should occur between February 1st and May 1st or between October 1st and December 1st.

Plants must be healthy and vigorous.

Mulch

Mulch can protect soil from compaction and erosion and may aid in holding moisture in the soil and suppressing weeds. Mulch should be weed-free and applied to cover all soil between plants. It should not be over-applied.

Manure mulching and high-fertilizer hydroseeding are prohibited in stormwater facilities.

Irrigation

Permanent irrigation systems are not allowed for stormwater facilities in public right-of-way, unless approved by BES. Alternative methods of irrigation for landscape establishment should be specified. Permanent irrigation systems are allowed for private facilities, but designers are encouraged to minimize the need for permanent irrigation. Innovative methods for watering vegetation are encouraged, such as the use of cisterns.

Pollution Prevention

Projects must be designed to minimize the need for toxic or potentially polluting materials such as herbicides, pesticides, fertilizers, or petroleum-based fuels within the facility area before, during, and after construction. Use of these materials creates the risk of spills, misuse, and future draining or leaching of pollutants into facilities or the surrounding area.

Materials that could leach pollutants or pose a hazard to people and wildlife should not be used as components of a stormwater facility. Some examples of these materials are chemically treated railroad ties and lumber, recycled crushed asphalt, and galvanized metals. Many alternatives to these materials are available.

Standard Landscape Requirements for Streets

See [Section 2.3.5](#) for right-of-way stormwater facilities planting templates and [Section 2.4.1](#) for plant lists. Typically, plants are specified in #1 containers and planted 12 inches on center. No medium to large shrubs are allowed in a stormwater facility next to a public street. Vegetation in stormwater facilities located in the public right-of-way constructed through a public works permit must be covered by a 2-year maintenance warranty period as described in [Chapter 3](#).

Planting is only allowed between February 1st and May 1st or between October 1st and December 1st. Planting outside of these times is only allowed with permission from Watershed Revegetation Program (503-823-2365).

The [landscape requirements for private streets](#) are implemented by the Bureau of Development Services.

Watershed Revegetation Program

Public Works Permit applicants (Permittees) may choose to enter into an optional agreement for vegetation services with BES's Watershed Revegetation Program during design and construction. This agreement is offered so that permit applicants can benefit from BES's professional expertise in establishing and maintaining stormwater management facility landscapes that treat public stormwater.

The Watershed Reveg Program can:

- Prepare a planting plan and plant establishment treatment schedule to meet the requirements of the *Stormwater Management Manual*.
- Reveg inspects stormwater facility blended soil for final grade and depth requirements.
- Source and acquire all plant material, and plant according to the plans. The City may interchange plant sizes and species due to nursery stock availability.
- Work with the permit holder to ensure that project implementation follows the permit, construction documents, design intent, and field conditions.
- Ensure prompt delivery of services with adequate coordination with other contractors.
- Provide all necessary labor and other miscellaneous work incidental to completion of planting, unless otherwise specified in the agreement.
- Install project signage, if appropriate.

Permittees can obtain more information directly from the Watershed Revegetation Program by calling 503-823-2365. See [Section 3.2](#) for services that Watershed Revegetation Program can perform during the 2-year maintenance warranty period.

2.3.4 Facility and Conveyance Design Criteria

This section provides the specific design requirements for each stormwater facility or conveyance feature listed in Figure 2-5. It also includes specific information regarding submittal requirements and construction considerations. Variations that exist between the Simplified, Presumptive, or Performance approaches and variations between public right-of-way and property are identified.

Figure 2-5. Stormwater Facility and Conveyance Features by Design Approach

	Simplified Approach for Private	Presumptive Approach for Private	Presumptive Approach for Streets	Performance Approach
Impervious Area Reduction Techniques				
Ecoroof	•			•
Pervious Pavement	•			•
Tree Credits	•	•	•	•
Vegetated Stormwater Facility				
Downspout Extension	•			
Rain Garden	•			
Swales	•	•	•	•
Curb Extensions			•	•
Planters	•	•	•	•
Basins	•	•	•	•
Filter Strips	•			•
Grassy Swales				•
Ponds				•
Subsurface Stormwater Facility				
Sand Filters				•
Soakage Trenches	•			•
Drywells	•			•
Sumps				•
Other Stormwater Facility Types				
Manufactured Stormwater Treatment Technologies				•
Rainwater Harvesting				•
Structural Detention Facilities				•
Stormwater Conveyance Features				
Drainageways and Drainage Reserves	Requirements not sizing approach dependent			

2.3.4.1. Ecoroof



Ecoroofs reduce impervious area and provide stormwater management.

Facility Description

An ecoroof is an impervious area reduction technique which decreases stormwater management requirements on the project site. Also called a green roof, an ecoroof is a lightweight vegetated system consisting of waterproofing material, a growing medium, and low growing, drought tolerant plants. Ecoroofs reduce post-developed peak runoff rates to near-pre-developed rates and reduce annual runoff volume by at least 50 percent. Ecoroofs also help mitigate runoff temperatures by keeping roofs cool and retaining most of the runoff during dry periods.

The roof structure must be strong enough to hold the additional weight of the ecoroof. The load-bearing capacity of the roof must be evaluated by a licensed professional, and the design must comply with building code requirements.

The design must be self-sustaining, meaning the design goal must be to minimize inputs after the first couple of years. This is in contrast to roof gardens which require more maintenance and irrigation.

Design Requirements

Sizing: Ecoroofs replace impervious area at a 1:1 ratio. They cannot receive runoff from other impervious areas except as reviewed and approved by BES under the Performance Approach.

Slope: The maximum allowable roof slope is 25 percent, unless the applicant provides documentation of runoff control on steeper slopes.

Access: The design must provide safe access for maintenance of the ecoroof and roof fixtures.

Waterproofing: All conventional commercial materials may be used, although a root barrier may be required for asphaltic materials. No portion of the waterproof membrane may be exposed to sunlight in order to maximize the life of the ecoroof.

Flashing: The design should minimize the use of copper or galvanized metal fittings which can introduce pollutants to the runoff.

Root barrier: A root barrier is sometimes required in addition to waterproofing material. Root barriers impregnated with pesticides, metals, or other chemicals which may leach into stormwater are not allowed, unless the applicant can provide documentation that leaching does not occur. If a root barrier is used, it must extend under any gravel ballast, under the growing medium, and up the side of any vertical elements. Some waterproofing materials also act as a root barrier.

Drainage and overflow: A method of drainage must be provided. The drainage layer may include geotextile fabric, gravel, or be the growing medium itself particularly on steeper, fast-draining ecoroofs. Ecoroofs are not a full stormwater disposal system and need a conventional drainage system to manage excess runoff from the roof during periods of sustained or heavy rainfall. The applicant must provide roof drains that connect to an approvable discharge location.

Growing medium: A minimum of 4 inches of growing medium is required for the vegetated portions of the ecoroof. The medium must support the chemical, biological, and physical needs of the plants. Designers are encouraged to use a medium with significant water-holding capacity to maximize stormwater retention. The medium should be an unconsolidated mixture of mineral aggregate such as screened pumice and sandy loam, and organic matter such as aged compost or fiber

compost. Other blends will be approved by BES on a case-by-case basis. Incorporation of chemical additives such as fertilizers and fungicides is not allowed. A depth of less than 4 inches may be allowed if the applicant demonstrates through the Performance Approach that applicable Chapter 1 requirements are met.

Vegetation and coverage: Drought-tolerant plants (per the ecoroof plant list in Section 2.4.1, Green Roof Plants by Snodgrass & Snodgrass, and/or equivalent) must achieve 90 percent coverage within two years. At least 50 percent of the ecoroof vegetation must be evergreen species. Ecoroof vegetation should be:

- Drought-tolerant, requiring little or no irrigation after establishment.
- Self-sustaining, without the need for fertilizers, pesticides, or herbicides.
- Able to withstand heat and cold.
- Very low-maintenance, needing little or no mowing or trimming.
- Perennial or self-sowing.
- Fire-resistant.

A mix of sedum/succulent plant communities is recommended because these plants possess many of the attributes listed above. Although herbs, forbs, grasses and other low groundcovers can provide stormwater and aesthetic benefits, plants that require irrigation beyond what is allowed in this section for survival are not permitted.

Mulch: Gravel mulch or an alternative mulch is recommended to retain moisture and protect exposed soil from erosion.

Non-vegetated components: Non-vegetated components may comprise up to 10 percent of the ecoroof while still counting toward the total ecoroof area, though the non-vegetated area should be kept to a minimum. If additional non-vegetated area is necessary to meet fire code requirements, the 10 percent maximum may be exceeded only by that required area. Rooftop features which cannot be considered non-vegetated components of an ecoroof include: mechanical equipment and solar panels (unless vegetation is extended beneath elevated units), elevator overruns, penthouses, and skylights. Runoff from portions of the structure that penetrate the ecoroof (e.g. elevator overruns and penthouses) must meet the provisions of this manual. Examples of non-vegetated components that can be counted within the 10 percent include:

- Decking or porous materials such as gravel or pavers which are placed over sand or another substrate for the purpose of providing access to the ecoroof and other rooftop components.
- Ballast along parapets or mechanical units.
- Other non-vegetated components may be allowed subject to BES review.

Ballast (optional): Gravel ballast is sometimes placed along the perimeter of the roof and at air vents or other vertical elements. It is sometimes used to provide maintenance access, especially to vertical elements that require regular, periodic maintenance. In many cases little, if any, ballast is needed.

Header/separation board (optional): A header or separation board may be placed between gravel ballast and adjacent elements such as soil or drains, but pressure-treated lumber is prohibited. In many cases a header is not needed, and designers are encouraged to use just one header if a header is needed.

Protection boards or materials (optional): These materials protect the waterproof membrane from damage during construction and over the life of the system and are usually made of soft fibrous materials. They often are not needed, depending on the membrane selected.

Habitat design (optional): BES encourages designs that benefit urban wildlife. Diversifying design elements such as soil type and depth is good for habitat: variable soil types and depths create microclimates, allowing varied species to use the ecoroof. For instance, small areas of sand, gravel or native topsoil benefit ground-nesting pollinators. Another element of a habitat-friendly ecoroof is varied vegetation. Large plant species provide additional structure, flower shapes, and bloom times, which in turn attract varied wildlife. Drought-tolerant native species are most effective at attracting native pollinators. Small areas of woody material and rock create microhabitats, encouraging more species (these elements must be secured to the roof or placed in locations where there is no risk of movement). A summer water source can be included such as a basin to collect condensate from rooftop units. Ecoroofs designed for habitat allow for areas with denser vegetation and areas with minimal vegetation. See typical details for an example of habitat-friendly ecoroofs.

Bird-friendly design (optional): Portland published a [Resource Guide for Bird-friendly Building Design](#) in July 2012. BES recommends reducing or eliminating building features with the potential to increase bird-strike mortality. In particular, glass and lighting near an ecoroof (e.g., an ecoroof on a podium level adjacent to a taller portion of the building) should comply with the guide recommendations. The vegetation will attract migratory birds as a source of habitat and food (insects and other prey for feeding). The U.S. Green Building Council introduced a pilot Bird Collision Deterrence LEED credit (Pilot Credit 55) in 2011, providing an incentive for projects that are pursuing LEED certification.

Title 33 Ecoroof Criteria

Ecoroofs that are proposed to meet a provision of Portland City Code Title 33 (Planning and Zoning) and must meet all of the design and maintenance standards in this chapter, and operations and maintenance standards in Chapter 3. Because ecoroofs are designed to manage area at a 1:1 ratio and are not designed to manage runoff from adjacent areas, the applicant should be aware that an ecoroof proposed to satisfy Title 33 standards may not on its own be sufficient to meet all of the requirements of this manual. In such cases, the project team must address stormwater management requirements for the remainder of the structure's roof by other means, e.g. through separate stormwater facilities or by expanding the ecoroof to 100% roof coverage.

Floor Area Ratio (FAR) Bonus: In some areas, Portland City Code Title 33 may award bonus floor area to projects that include an ecoroof (e.g. Gateway Plan District, Mixed Use Zones). Where called for in Title 33, BES will issue a certification letter through the City's land use review process once the applicant has provided sufficient materials to confirm that the ecoroof complies with the standards of this manual. In order to receive a BES letter of certification prior to issuance of a land use decision, the applicant should submit all of the materials listed below with the land use application.

Ecoroof Requirement: Portland City Code Title 33 may require an ecoroof for projects located in specific areas or zoning designations. BES will not issue a letter of certification for ecoroofs that are required by Title 33, but will review the ecoroof for compliance with the standards outlined in this manual through the City's land use and/or building permit review process.

For ecoroofs proposed to meet either regulatory provision presented above, the following materials must be submitted to BES for review:

- Planting plan and plant list with detailed square footage breakdown.
- Cross sections, typical details, and related specifications. Include a cross section and description of waterproof membrane and root barrier system.
- Specification for the plant cover and method for vegetation application.
- Drainage plan.
- Soil specification, including weight and depth.
- Operations and maintenance plan.
- Planned water use and/or irrigation system.

Typical Details: See Section 2.3.5 (SW-100's) for ecoroof typical details.

Submittal Requirements

See Section 2.4 for submittal requirements for the design specific approach.

2.3.4.2. Pervious Pavement



Two types of pervious pavement: pervious concrete (foreground) and pervious pavers (background). Pervious pavements reduce impervious area and provide stormwater management.

Facility Description

Pervious pavements are impervious area reduction techniques that decrease the obligation of stormwater management on the project site. These methods of infiltrating stormwater provide a stable load-bearing surface without increasing the project impervious area. There are two main categories of pervious pavements: pervious concrete and pervious asphalt, which are poured in place, and permeable pavers, which are discrete units set in place.

Pervious asphalt, pervious concrete, and permeable pavers can be used in practically all pedestrian areas as well as residential driveways and commercial parking lots. Pervious asphalt and concrete will be approved on private streets and public roadways on a case-by-case basis. For all streets, the pavement design must be prepared by a registered professional engineer.

Pervious Asphalt and Concrete. Pervious asphalt and pervious concrete are similar to conventional asphalt and concrete in structure and form, except that the fines (sand and finer material) have been removed. The top lifts are thicker than traditional pavements to provide the required stability. When properly handled and installed, porous paving has a high percentage of void space (approximately 17 to 22 percent).

Pervious asphalt consists of an open-graded coarse aggregate cemented together by asphalt cement. The Oregon Department of Transportation (ODOT) has approved a pervious asphalt mix for use on public highways and freeways, and refers to it as an open-graded ½-inch or ¾-inch asphalt mix design.

Pervious concrete is a structural, open-textured pervious concrete paving surface consisting of standard Portland cement, fly ash, locally available open-graded coarse aggregate, admixtures, fibers, and potable water.

Permeable Pavers. There are many types of permeable pavers on the market. Many manufacturers make specific pavers for pervious applications. Brand names and specifications must be supplied with permit applications.

Edge restraints for pavers are required to be permanent (cast-in-place or precast concrete curbs) and a minimum of 6 inches wide and 12 inches deep for private streets, public roadways, and commercial pavements. Residential restraints may be plastic and set with spikes.

Design Requirements

Additional stormwater from other impervious areas, such as rooftops, may not be directed to a pervious pavement system under the Simplified Approach. Pervious pavements must not be located over cisterns, utility vaults, underground parking, or other impervious surfaces.

Soil Suitability: A minimum distance of five feet to seasonally high groundwater is required. Where the tested infiltration rate is less than 2 inches/hour, the pavement section must sheet-flow to an adequately sized filter strip (500 square foot limit for pavement), or the pervious pavement subsurface rock may be sized for necessary detention. If an underdrain is proposed for collection, the conveyance must lead to a vegetated facility sized to treat the entire pervious paved area.

Setbacks: There are no required setbacks, but impermeable liners between base rock and adjacent foundations are highly recommended. A liner may be required for

areas located within 5 feet of structures or infrastructure. See Exhibit 2-1 for more information on setbacks.

Sizing: Sizing requirements vary by design approach.

Simplified Approach: Pervious pavement and permeable pavers replace impervious surfaces at a 1:1 ratio.

Performance Approach: Pervious pavement designed under the performance approach must be designed to directly infiltrate all stormwater from the pavement surface into a crushed rock storage layer, which must contain enough void space to store the 10-year, 24-hour storm and infiltrate it into the subgrade in less than 30 hours.

Slope: Where slopes are greater than 5 percent, the design must be engineered to specifically address under-pavement water retention. If the slope of the area is 10 percent or greater, pervious pavement is not allowed.

Subgrade: Pervious pavement must not be constructed over fill soils. The area to be paved should be leveled and lightly compacted with a plate compactor to include a slight grade away from foundations. Subgrade must not be subject to truck traffic. The subgrade should not be constructed or compacted during wet conditions.

Geotextile fabric: Subgrade geotextile for separation may be desired between subgrade (native soil) and aggregate base (gravel layer), but is not required. Specify per geotechnical professional or manufacture.

Aggregate base: 6-inch minimum of washed, crushed 2- to $\frac{3}{4}$ -inch or No. 57 rock.

Top lift: See Figure 2-6. Pervious Pavement Requirements for the top lift depth requirements for private property under the Simplified Approach. Asphalt and concrete must have at least 15 percent air voids in the completed top lift. Concrete must be 2400 to 2500 psi in 28 days. Pervious pavement requirements for public or private streets must be engineered. Public streets must also meet current City Standard Specifications.

Figure 2-6. Pervious Pavement Requirements

	Concrete (inches)	Asphalt (inches)	Paver (inches)	Engineering Required?	Compaction Required?
Residential Driveway or Pedestrian Only	4	2.5	2 $\frac{3}{8}$	No	No

Typical Details: See [Section 2.3.5](#) for typical details for pervious pavement.

Submittal Requirements

See [Section 2.4](#) for submittal requirements for the design specific approach. When considering permeable pavement for the public right-of-way, private streets, and parking lots, the project must be designed under the Performance Approach. Permeable pavement in the public right-of-way is approved on a case-by-case basis at the discretion of the City of Portland’s Chief Engineers, and must be designed by a registered professional.

When considering pervious pavement for private streets, the applicant must meet the specifications of the [BDS’s private street administrative rule](#). A site development permit is required for private street construction.

Since achieving structural integrity and infiltration ability can be difficult, the pervious concrete supplier may be required to submit a testimonial with the permit application that the pervious mix will accomplish both tasks. Test panels may be required.

Construction Considerations

It is imperative during design and construction to establish protection for the pervious pavement subgrade from over-compaction. The subgrade should not be constructed or compacted during wet conditions. The design professional must show how the project will be sequenced to avoid traffic on the subgrade of the proposed paved area, and how the paving will be protected from construction traffic, and sediment accumulation after installation.

Construction sequencing should avoid heavy truck traffic and sediment on the paving. A pervious pavement protection plan may be required in order to protect the surface from compaction during construction.

2.3.4.3. Tree Credits



Trees intercept rainfall and reduce runoff.

Facility Description

Trees intercept precipitation and provide several stormwater management benefits: they hold water on their leaves and branches and allow it to evaporate, retain flow, and dissipate the energy of runoff. These functions are most measurable for storms of less than 0.5 inch over 24 hours, typical of Portland storm events. Although deciduous trees are not as effective during winter months, evergreen trees are effective year-round for these smaller storms and portions of larger storms. Generally, large trees with small leaves are the most efficient rainfall interceptors. Trees also facilitate stormwater infiltration and groundwater recharge.

Trees can also shade impervious area. This provides two direct benefits. First, the hard surface is protected from direct solar exposure, which reduces heat gain. The less heat gain there is in pavement, the less heat is absorbed by stormwater as it flows over the surface. Second, by shading pavement, the trees help reduce or minimize air temperature increases caused by the hot pavement.

Existing trees can have significant benefits in addition to stormwater management. Trees provide habitat for urban wildlife, energy conservation, aesthetics, visual screens, heritage value, windbreaks, recreation, and improve human health.

Trees are allowed as an impervious area reduction technique on both private property and in the public right-of-way under specific criteria and with provisions. The specifications that follow were developed to maximize the use of trees to mitigate stormwater impacts and to support the implementation of Title 11 (Trees). The City Forester maintains authority over trees in the public right-of-way. BES will inspect trees on private property during installation and during post-construction operations and maintenance visits, and the property owner is responsible for maintenance. Title 11 requirements apply to all trees.

Design Requirements

Site applicability: The tree credit can be used for all sites. For sites with over 1,000 square feet of impervious surface to manage, no more than 10 percent of the impervious area can be mitigated through the use of trees. Exceeding this allowance in the right-of-way will be considered on a site by site basis under staff discretion.

New tree sizing: New broadleaf trees on private property must be at least 1.5 caliper inches at the time of planting, and new coniferous trees must be at least 5 feet tall OR meet Portland City Code Title 11 requirements, whichever is greater, to receive credit.

New tree setbacks: New trees must be planted within 10 feet of impervious surfaces. One hundred square feet of credit is given for new broadleaf trees, and 200 square feet of credit is given for new coniferous trees (see minimum tree sizes below).

Street trees planted less than 10 feet from a water line (or other water infrastructure such as a water meter) require the installation of a tree root barrier, per [Standard Drawing P-581](#).

Existing tree sizing and setbacks: Credit also applies to existing trees kept on a site if the trunk is within 25 feet of impervious surfaces and are at least 1.5-inch caliper or larger. Caliper is the diameter of the tree measured 6 inches above the ground surface or root ball. The tree credit for existing trees is tiered based on caliper (see Figure 2-7).

Figure 2-7. Stormwater Credit for Existing Trees

Caliper of Existing Tree	Stormwater Credit
1.5 up to 6 inches	200 square feet
6 inches and larger	400 square feet per each 6 caliper inches

Tree selection: The trees selected must be suitable species for the site conditions and the design intent. Nuisance trees cannot receive stormwater tree credit. BES may require a certified arborist’s report to verify suitable tree selection and preservation. See [Section 2.4.1](#) for plant species information.

Trees on private property: Proposed trees are reviewed by BDS staff. This area should be marked on plans and protected during construction.

Street and public trees: By City ordinance, the City Forester is authorized to set standards for tree sizes planted on publicly owned lands and public rights-of-way. A permit is required from Urban Forestry to plant, prune, or remove trees in the public right-of-way. See Title 11 requirements regarding street trees and other public trees.

Other considerations: Trees planted to meet stormwater facility planting requirements cannot also receive impervious area reduction credit. New or existing trees counting towards environmental zone mitigation cannot receive tree credit. Tree credits may not be allowed if site circumstances or system limitations exist.

Typical Details: See Title 11 Code for tree requirements relating to development situations. See [Section 2.3.5](#) (SW-300’s) for typical details relating to incorporating trees into vegetated stormwater facilities in the public right-of-way.

Submittal Requirements

See [Section 2.4](#) for submittal requirements for the design specific approach. Trees to be given credit as an impervious area reduction technique must be clearly labeled as such, with the size (as provided in the [Bureau of Development Services Tree and Landscaping Manual – Plant Materials](#)) and species included. Approximate setbacks from property lines and structures must be shown. Temporary irrigation measures must be shown, if applicable. A note must be included on the permit drawings that calls for City inspection after the tree has been planted, or in the case of existing canopy, after the site grading has been completed. Trees proposed for stormwater credit will need to be included in the required O&M Plan. BES will require BDS approval and may require a survey and certified arborist report to verify suitable tree selection or tree preservation for any trees designated for stormwater tree credit.

Construction Considerations

Protection of existing trees during construction must meet Title 11 requirements. Alternative protection may be proposed via the performance path in Title 11 and is approved by BDS staff. The applicant will have to provide documentation required by the code to ensure the tree will remain healthy after construction and for the life of the tree.

2.3.4.4. Downspout Extension



Downspout extensions route runoff from roof areas to adjacent landscape.

Facility Description

Directing downspouts to splash blocks is a method of stormwater management that directs roof runoff to vegetated or mulched landscape areas for onsite infiltration. This method can be utilized for small-scale projects on private property that have appropriate site conditions. Roof runoff is directed to existing landscaping where it can spread out and safely soak into the soils and remain on the property. Site conditions will determine if this is a suitable method for managing stormwater onsite. Property line and building setbacks as well as surface grade and available landscaped areas for infiltration must be considered. Proposed downspout locations and roof/gutter alignments will impact the feasibility of this option. As such, a preliminary site visit by BES staff is recommended to determine if downspout extensions are a viable option.

Design Requirements

Site Suitability: Downspout extensions are suitable for sites that have well draining soils (>2 inches/hour) and have an overall slope of 10 percent or less. A maximum of 500 square feet of roof area is allowed to drain to each downspout. For new development or redevelopment, only small-scale projects on private property with less than 1,000 square feet of new impervious area, including garages, additions, and accessory dwelling units, are eligible to use this method. For stormwater retrofits or alterations to existing structures, the structure must be smaller than 5,000 square feet.

Setbacks: Downspouts typically discharge 2 feet from slab on grade and structures with crawl spaces and 6 feet from all foundations with basements. The point of discharge typically are set back 5 feet from property lines and 10 feet from all neighboring structures or buildings and retaining walls over 36 inches in height. Splash blocks are not considered part of the downspout extension and are included for erosion control and flow dispersal only. See Table 2-1 for more information on setbacks.

Sizing and grade: The landscape area utilized for disposal of stormwater must be at least 10 percent of the roof area that drains to each downspout. The grade of the landscape area must gently slope away from the foundation and neighboring properties and allow stormwater to spread out over the required 10 percent infiltration area. Setback requirements must be retained over the entire infiltration area.

Materials: Durable, gutter-grade materials such as aluminum, steel, copper, vinyl, and plastic downspouts can be utilized for extensions. Downspouts need to be secured to the structure and connections securely fastened together with appropriate materials (i.e., sheet metal or similar screws). Flexible downspout extensions are not approvable materials. Rain chains must be securely fastened to the structure and the ground in a vertical alignment and must meet setback standards in order to be approved. Splash blocks, rock, or flagstone must be utilized for erosion control and flow dispersal at the location of discharge. Downspouts can be directed to drain onto grass without additional erosion control measures.

Other Considerations: Downspouts must not be directed to drain onto or over impervious areas, including walkways, driveways, and patios or onto neighboring properties, including public sidewalks and streets. Downspouts and gutters may be regraded, piped, or redirected in order to convey water to a safe infiltration area. Downspouts need to drain directly to landscape areas intended for infiltration.

Landscaped areas above buried oil tanks or adjacent to retaining walls over 36 inches high cannot be utilized as infiltration areas.

Typical Details: See [Section 2.3.5](#) for typical details for downspout extensions on private property under the Simplified Approach (SW-100's).

Submittal Requirements

See [Section 2.4](#) for submittal requirements for the design specific approach. An applicant for downspout extension approval must submit a site plan that notes downspout locations and roof drainage areas and that clearly illustrates roof area limitations, setbacks, and infiltration area requirements can be met. Alternate onsite disposal methods such as soakage trenches will be required upon inspection for sites that cannot meet applicable downspout extension setback and landscape requirements.

Construction Considerations

Downspouts need to be located in areas that can accommodate stormwater flows and do not cross walkways or drain onto driveways, patios, or other impervious surfaces. Downspout locations and quantity can be field-fit based on site conditions to meet required standards. The design should consider landscape grade during construction to ensure the finished landscape grade will allow stormwater to drain safely away from building foundations and property lines. Hinged downspout extensions or “flipper” extensions can be utilized for ease of landscape maintenance.

2.3.4.5. Rain Garden



Rain gardens are shallow landscape depressions which collect runoff and allow it to infiltrate.

Facility Description

Rain gardens are a method of stormwater management that directs roof and/or paved area runoff to a shallow, flat, vegetated landscape depression amended with compost to allow for onsite infiltration. Rain gardens can meet stormwater requirements for new and redevelopment projects that manage less than 5,000 square feet of roof and paved areas. Site conditions will determine if this is a suitable method for managing stormwater onsite. Property line and building setbacks as well as surface grade and available landscaped areas for infiltration must be considered. Proposed downspout locations and roof/gutter alignments will impact the feasibility of this option, as well as slope, setback, and other site considerations.

Design Requirements

Site Suitability: Rain gardens are suitable for sites that have well-draining soils (>2 inches/hour) and have an overall slope of 10 percent or less. New development and redevelopment projects with less than 5,000 square feet of new impervious area are

eligible to use this method. This requirement also applies to stormwater retrofits or alterations to existing structures.

Setbacks: A ten-foot setback from buried oil tanks or retaining walls over 36 inches high is required for safety considerations. It is also recommended to avoid installation over water service lines. The deepest point of a rain garden should be at least 10 feet from all structures. Each downspout or rain drain entering the rain garden must be at least:

- 2 feet from any onsite building foundations without a basement,
- 6 feet from any onsite building foundations with a basement,
- 10 feet from a neighbor's building,
- 5 feet from a property line,

Sizing and grade: The rain garden footprint must be at least 10 percent of the impervious area that drains to each rain garden. The footprint is the area of the rain garden capable of detaining water when full, including facility side slopes.

If site infiltration rates are higher than 2 inches/hour, consider using the Presumptive Approach in order to design a smaller basin.

Each rain garden design needs to include an escape route so that stormwater safely drains in periods of heavy rainfall. Escape routes can simply be low points in the perimeter of the rain garden that allow excess stormwater to safely drain away from building foundations to a driveway, sidewalk, street, or parking lot and without impact to adjacent properties. Escape routes should be planted or rocked to prevent potential erosion issues.

If an escape route is not available given site conditions, a piped overflow is allowed. Overflows need to have an approved disposal location such as a public storm sewer, adjacent creek, or onsite disposal system such as a drywell.

Dimensions and Slopes: The grade of the rain garden must gently slope away from the foundation and neighboring properties. Setback requirements must be retained over the entire infiltration area. Rain gardens must not be installed at locations on the site where slope is greater than 10%.

Rain gardens will be constructed to a ponding depth of 12 inches with maximum side slopes of 3 horizontal to 1 vertical and a minimum bottom width of 2ft x 2ft. Side slopes of 2 horizontal to 1 vertical may be allowed if erosion control protections are installed, such as vegetative cover and/or larger boulders.

Materials: Water runoff from the roof may be conveyed to the point of discharge in one of the following manners:

- A gutter-grade downspout extension above ground.
- A downspout extension positioned below ground, daylighting into the facility. Where located within the 2-foot or 6-foot setback, the pipe must be watertight. Where located completely below ground, a patio, or a walkway, it must be composed of cast iron or Schedule 40 ABS to comply with the Oregon Plumbing Specialty Code.
- A rock-filled drainage channel (“dry creekbed conveyance swale”) lined with moisture-impervious sheeting, such as 30-mm EPDM, where located within the 2-foot or 6-foot setback.

Flexible downspout extensions are not approvable materials. Splash blocks, rock, or flagstone must be utilized for erosion control and flow dispersal where the stormwater enters the rain garden.

Growing Medium: Amend native soils with 3 inches of compost blended into the top 12 inches of native soil.

Vegetation: The entire facility area must be planted with vegetation as per Figure 2-8 . The facility area is equivalent to the total area of the rain garden, including bottom and side slopes, as developed in the sizing calculations. See [Section 2.4.1](#) for suggested plant material.

Figure 2-8. Rain Garden Vegetation - Zone A and B

Number of Plants	Vegetation Type	Per square feet	Size	Spacing density (on center)
80	Herbaceous plants	100	#1 container	1.25'
OR				
72	Herbaceous plants	100	#1 container	1.25'
4	Small or large shrubs	100	#2 container	1'

If the total project area is over 200 square feet consider adding a tree and reducing the number of herbaceous plants and shrubs.

Mulch: Rain gardens may be topped with 2” of compost cover to enhance soil moisture, prevent weeds and control erosion. Bark mulch or equivalent should only be applied above the high water line.

Typical Details: See [Section 2.3.5](#) for typical details for rain gardens designed under the Simplified Approach ([SW-100's](#)).

Submittal Requirements

See [Section 2.4](#) for submittal requirements for the design specific approach. An applicant for rain garden approval must submit a site plan that notes downspout locations and roof drainage areas and that clearly illustrates roof area limitations, setbacks, and infiltration area requirements can be met. Alternate onsite disposal methods such as soakage trenches will be required upon inspection for sites that cannot meet applicable rain garden setback and landscape requirements.

Construction Considerations

Infiltration areas should be clearly marked before site work begins to avoid soil compaction or sedimentation to preserve infiltration capacity. No vehicular traffic, except that specifically used to construct the facility, should be allowed within 10 feet of infiltration areas.

Rain gardens need to be located in areas that can accommodate stormwater flows and do not cross walkways or drain onto driveways, patios, or other impervious surfaces. The design should consider landscape grade during construction to ensure the finished landscape grade will allow stormwater to drain safely away from building foundations and property lines.

2.3.4.6. Swales



Swales collect and convey runoff to a discharge location, filtering the runoff, and allowing it to infiltrate.

Facility Description

Swales are typically long, narrow, gently sloping landscaped depressions that collect and convey stormwater runoff. They are planted with dense vegetation that treats stormwater from rooftops, parking lots, and streets. As the stormwater flows along the length of the swale, the vegetation and check dams slow the stormwater down, filter it, and allow it to infiltrate into the ground. Where soils do not drain well, swales can overflow to an approved discharge location such as a drywell or sump. Swales should be integrated into the overall site design and can be used to help fulfill landscape requirements. Grassy swales are a separate facility type and require the Performance Approach.

Design Requirements

Soil suitability: Existing infiltration rates will determine if the facility can be designed to achieve infiltration, partial infiltration, or allow the stormwater to be conveyed through the facility. See [Section 2.3.6](#) for infiltration testing procedures.

Simplified Approach: For the Simplified Approach (Section 2.2.1), if the tested infiltration rate is greater than or equal to 2 inches per hour, the simplified swale design meets all requirements. If the tested infiltration rate is less than 2 inches per hour, the swale should be designed as a partial infiltration facility, with an overflow to an approved discharge location.

Presumptive Approach: For the Presumptive Approach (Section 2.2.2), the existing infiltration rate also determines the type of swale, but additional variables are factored in to determine the configuration of the facility.

Setbacks: Setback requirements vary by location.

Private property requirements: Infiltration swales are typically set back 5 feet from property lines and 10 feet from building foundations. There are no setback requirements for lined swales. See Table 2-1 for more information on setbacks.

Right-of-way requirements: If a basement is within 10' of an infiltration swale, a partial liner may be required on the basement side of the swale.

Sizing: Sizing requirements vary by design approach.

Simplified Approach: A sizing factor of 0.09 is required.

Presumptive Approach: The Presumptive Approach Calculator allows the designer to size stormwater facilities with respect to native infiltration rates and other unique site conditions of the project.

Performance Approach: Must be engineered to meet site-specific stormwater requirements.

Dimensions and slopes: Requirements vary by location and design approach.

Simplified Approach: The minimum swale width is 9 feet. A 2-foot-wide flat bottom width is required where feasible. The depth is nine inches as measured from the top of the growing medium to the overflow inlet elevation. Maximum side slopes are 3 horizontal to 1 vertical; 4 horizontal to 1 vertical is required immediately adjacent to pedestrian areas. Maximum longitudinal slope is 6 percent. Freeboard for swales must be noted on the plans.

Presumptive approach on private property requirements: The minimum swale width is 9 feet. A 2-foot-wide flat bottom width is required where feasible. Swale depth per Presumptive Approach Calculator. Maximum side slopes are 3 horizontal to 1 vertical; 4 horizontal to 1 vertical is required immediately adjacent to pedestrian areas.

Right-of-way requirements: The minimum swale width is 8 feet. A 2-foot-wide flat bottom width is required where feasible. The maximum ponding depth is 9", unless otherwise approved. See [Section 2.3.5](#) for Green Street typical details for side slope requirements. Maximum longitudinal slope is 6 percent.

Waterproofing/Geosynthetic Liner: Requirements vary by location.

Private property requirements: Liner must be 30-mil EPDM, HDPE, or approved equal.

Right-of-way requirements: Full or partial liners may be required for protecting adjacent water facilities/utilities, on higher classification streets, in locations with hazardous materials or topography considerations, and in wellhead protection areas. The location determines the required liner thickness, see below. All liners must be attached per the Green Street details in [Section 2.3.5 Typical Details](#). Other methods may be considered where impervious or waterproof facilities are required, such as single-pour concrete forms.

- 30 mil HDPE – water main and road protection
- 40 mil HDPE – Columbia Southshore Well Field Wellhead Protection Area

Piping: Requirements vary by location.

Private property requirements: Piping must be cast iron, ABS SCH40, or PVC SCH40. Three-inch pipe is required for facilities draining up to 1,500 square feet of impervious area; otherwise, a 4-inch pipe minimum is required. Piping installation must follow current Plumbing Code.

Right-of-way requirements: 6-inch or 8-inch ASTM 3034 SDR 35 PVC pipe and perforated pipe are required. Refer to the City's [Sewer and Drainage Facilities Design Manual](#) for more information.

Drainage Layer: Requirements vary by location and design approach.

Simplified Approach requirements: 12" depth of ¾" – 1 ½" washed drain rock must be used. Drain rock and growing medium must be separated by a 2- to 3-inch layer of pea gravel.

Presumptive approach on private property requirements: Determined by designer and PAC calculations. Options include, but are not limited to drain mat, ¾" washed rock, or other approved system. Separation between growing medium and drainage layer may be appropriate filter fabric or a gravel lens (pea gravel 2 to 3 inches deep), or as per approved design.

Right-of-way requirements: 1 ½" - ¾-inch round washed drain rock may be required per PAC calculations. Drain rock and growing medium must be separated a 2-inch to 3-inch layer of ¾-inch to No. 4 open graded aggregate. Geotextile fabric is prohibited.

Check dams: Requirements vary by location.

Private property requirements: They generally measure 4 to 10 inches high, depending on the depth of the facility. Width will vary depending on material.

Right-of-way requirements: Place check dams per PAC calculations to maximize volume. See [Section 2.3.5](#) for Green Street typical details (SW-300's).

Growing medium: Requirements vary by location.

Private property requirements: The imported soil must be a sandy loam mixed with compost or a sand/soil/compost blend. It must be roughly one-third compost by volume, free-draining, and support plant growth. The compost must be derived from plant material; animal waste is not allowed. The Stormwater Facility Blended Soil for public facilities is also acceptable, see [Section 2.3.6](#).

If a stormwater management facility is proposed adjacent to property lines or nearby structures, then a lined facility will likely be required. Vegetation planted within water-tight stormwater management facilities cannot compromise the integrity of the facility liner and the facility design must ensure plants will survive. The applicant must coordinate with BES and BDS staff regarding applying BES Stormwater Management Manual requirements, while meeting landscaping requirements. To provide adequate area for plants to grow, vegetation must be planted within a minimum growing medium depth of 24 inches.

Right-of-way requirements: For streets, the Stormwater Facility Blended Soil is specified in [Section 2.3.6](#). The imported growing material must be 18 inches deep, or less, if native soils drain well.

Vegetation: The entire facility area must be planted with vegetation. The facility area is equivalent to the total area of the swale, including bottom and side slopes, as developed in the sizing calculations. See [Section 2.4.1](#) for suggested plant material appropriate for private property and required plant material for the public right-of-way. Swales should be designed so they do not require mowing.

Private property requirements: The entire facility area must be planted with vegetation as per Figure 2-9. (Private) Swale Vegetation - Zone A and Figure 2-10. (Private) Swale Vegetation - Zone B. The facility area is equivalent to the total area of

the swale, including bottom and side slopes, as developed in the sizing calculations. See [Section 2.4.1](#) for suggested plant material appropriate for private property and required plant material required for the public right-of-way. Swales should be designed so they do not require mowing.

Figure 2-9. (Private) Swale Vegetation - Zone A

Number of Plants	Vegetation Type	Per square feet	Size	Spacing density (on center)
80	Herbaceous plants	100	#1 container	1.25'
OR				
72	Herbaceous plants	100	#1 container	1.25'
4	Small shrubs	100	#1 container	1'

Figure 2-10. (Private) Swale Vegetation - Zone B

Number of Plants	Vegetation Type	Per square feet	Size	Spacing density (on center)
7	Large or small shrubs	100	#2 container	2'
70	Groundcover	100	#1 container	1'

If the total project area is over 200 square feet consider adding a tree and reducing the number of herbaceous plants and shrubs.

Right-of-way requirements: See [Section 2.3.5](#) for typical Green Street details and planting templates and [Section 2.4.1](#) for Plant List for Public Stormwater Facilities. Plantings adjacent to streets require special attention to line-of-sight and maintenance issues. Vegetation should be planted so it does not block traffic sight lines or require mowing. No medium to large shrubs are allowed. Minimum container size is #1 container. Plants to be spaced per Plant List for Public Stormwater Facilities in [Section 2.4.1](#) and requirements on drawing [SW-362](#).

Mulch: Requirements vary by location.

Private property requirements: Fine to medium hemlock mulch is recommended for swales. It should be placed in the facility only in areas above the high-water line. Care should be given to keeping mulch material out of a stormwater flow path to

avoid any material from clogging inlets or outlets or otherwise escaping the facility. It must be weed-free and applied 2 to 3 inches thick to cover all soil between plants. It should not be over-applied.

Right-of-way requirements: Mulch may be allowed by BES on a case-by-case basis. Mulch will only be allowed on facilities with side slopes that do not have an aboveground overflow drain. Mulch must not inhibit water flow in the flow path, inlets, or outlets. Mulch material must be fine to medium 100% hemlock bark free of dyes and pesticides. Mulch must be applied after beds are clear of weeds and debris, after planting and watering-in of new plants is complete and after the soil surface is brought to a smooth, finished grade. Mulch must be applied in planted areas to an even, uniform depth of 2 inches. Keep mulch off plants, structures, roadways, shoulders, walks, and lawns. Mulch must not cover herbaceous plants or come into contact with the stems of woody shrubs or trees. Mulch surface must be left with a smooth, finished appearance as approved by the City.

Typical Details: See [Section 2.3.5](#) for typical details for swales designed under the Simplified Approach (SW-100's), the Presumptive Approach on private property (SW-200's) and for Green Streets in the public-right-of-way (SW-300's).

Submittal Requirements

See [Section 2.4](#) for submittal requirements for the design specific approach.

Construction Considerations

Infiltration swales areas should be clearly marked before site work begins to avoid soil compaction or sedimentation to preserve infiltration capacity during construction. No vehicular traffic, except that specifically used to construct the facility, should be allowed within 10 feet of infiltration swale areas.

2.3.4.7. Curb Extensions



Curb extensions are street-side landscape areas which store, filter, and infiltrate stormwater runoff. Photo credit: Henry Ngan.

Facility Description

Stormwater curb extensions are typically used in retrofit situations to manage runoff from developed rights-of-way. They can provide locations for stormwater management when space behind an existing curb line is constrained or inadequate in size.

Stormwater curb extensions effectively intercept stormwater from the street gutter and send it into gently sloping or flat-bottomed facilities. Within the facilities, vegetation and check dams slow the stormwater down, filter it, and in many cases allow it to infiltrate into the ground. In locations where soils do not drain well, curb extensions can overflow to an approved discharge location, such as a storm sewer, sump, or open channel drainage way, such as a creek or stream.

Curb extensions can improve auto, pedestrian, and bicycle safety by narrowing the crossing distance for pedestrians, improving sight lines, and providing a visual presence in the roadway to slow cars approaching intersections.

The presence of utilities, potential loss of on-street parking spaces, and the narrowing of the road are all considerations for curb extension placement and design.

If proposed via Public Works Permit then consult with PBOT early on if these can be allowed/approved.

General Guidelines

Local Service Streets (as defined by the Portland Bureau of Transportation) typically accommodate curb extensions and the design considerations outlined below are directed primarily for this application. Curb extensions can also be accommodated on higher classification streets using similar design considerations. However, significantly more scrutiny and review are required to ensure vehicle and pedestrian safety, safety for maintenance crews, and adequate sizing of the facility for those situations. Additional considerations for higher classification streets may include analysis for future transportation system demands. These demands may call for future travel lanes, bike lanes, or turn lanes that would potentially conflict with a curb extension. Other facility types may be more appropriate for high traffic areas.

Curb extensions should be designed for optimal collection of stormwater to fit into the existing streetscape to the maximum extent practicable. Designers should take into consideration the impact to adjacent property owners and preserving existing desirable amenities within the right-of-way such as on street parking, walkways, landscaping, street trees, and utilities.

Since curb extensions occupy space typically used for on-street parking, a technique for mitigating impacts to adjacent property owners is centering surface stormwater facilities between properties (e.g. centered on property lines perpendicular to the facility). Even though this may not be the most efficient location for collection of stormwater, it reduces the impact to one property by spreading it over two. This technique can allow for at least one on-street parking space to be retained on each property frontage. In general, projects should avoid removing parking entirely along frontages without driveways or off-street parking areas.

For mid-block curb extension applications, it is acceptable for stormwater to flow into a facility and then back out (via a passive surface overflow). When a stormwater curb extension is combined with pedestrian ramps at corners, stormwater should be

collected within the facility to the maximum extent practicable. This may include the installation of underdrains and/or overflow inlets within the stormwater facilities. Stormwater must not flow across the base of the pedestrian ramps when exiting the facility.

The development potential of adjacent property should be considered to the maximum extent practical when placing facilities. For example, an undeveloped or underdeveloped lot might require a driveway at a future time, which could conflict with a surface stormwater facility. The Bureau of Development Services should be contacted to determine if a development inquiry or building permit exists for adjacent properties.

Street Design Requirements and Considerations

A curb extension in an existing right-of-way is considered to be an alteration. As a result, the federal law requires a curb extension project improve adjacent corners that do not have pedestrian ramps. See [Standard Drawing P-548](#) of the City of Portland Standard Construction Specifications.

For corner applications, stormwater curb extensions must be placed at the Point of Curvature (PC) or the Point of Tangency of a corner radius or as close to the corner ramp as possible without blocking the pedestrian ramp. Where a curb extension cannot be placed at or very close to the PC of a corner radius, stormwater curb extensions must be moved back approximately 18 feet to allow for a legal parking space.

Stormwater curb extensions proposed on both sides of a street corner must be incorporated into a full curb extension including the corner ramps (See Figure 2-11). Subject to BES approval, a single stormwater curb extension can be placed on one side of a corner without requiring that the corner ramp be incorporated into the extension. The specific geometry requirements for a full corner curb extension are determined by Portland Bureau of Transportation (PBOT) traffic engineers according to site conditions.

Corners with pedestrian ramps must be constructed (see Figure 2-11) in a Pedestrian District or City Walkway per the City's Transportation System Plan. If there is a safety benefit to shortening the crossing distance for pedestrians, and/or if the street is a designated Safe Route to School and on higher classification streets, these requirements will be conveyed by Transportation staff.

For midblock applications, locate stormwater curb extensions at the wing of a driveway or at least 18 feet from a driveway wing to either remove or allow for parking.

Figure 2-11. Acceptable Curb Extension Configurations

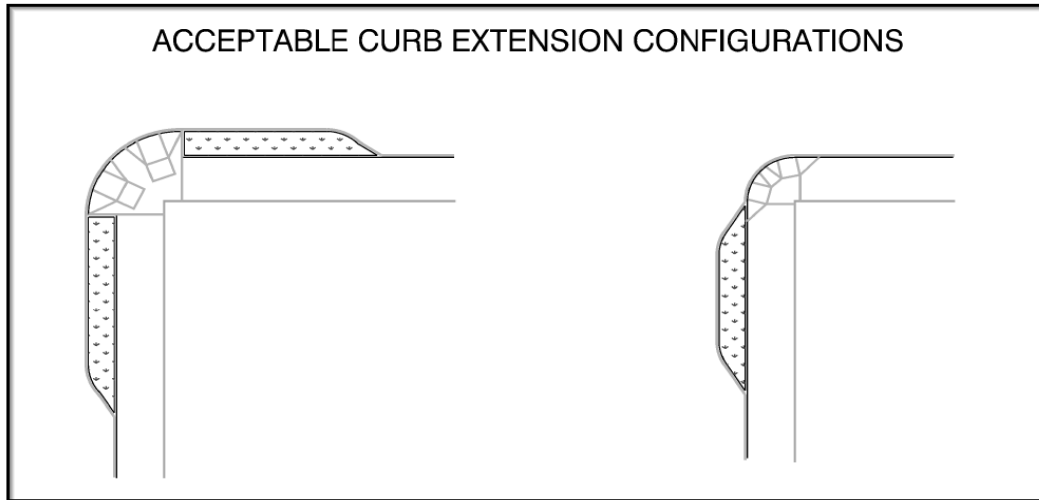

The presence of existing fire hydrants and mature street trees will impact placement of curb extensions. Consequently, coordination with the Portland Water Bureau and Portland Parks and Recreation is necessary.

A thickened curb and gutter per [City of Portland Standard Construction Specification Drawing P-540](#) must be used along the street side of all surface stormwater facilities in the public right-of-way.

Typical curb extensions vary in width from 4 to 6 feet as measured from the face of the existing curb to the street-facing face of a new curb. The actual width of the curb extension varies depending on many factors, including but not limited to: existing street width, on-street parking, bike lanes, traffic engineering considerations, and conflicts with utilities, such as water lines. A distance of 20 feet between curbs on opposite sides of the street must be maintained on all local, two-way residential streets per Portland Fire Bureau requirements, unless specific exceptions are approved (see Figure 2-12). See [Section 2.3.5](#) for stormwater curb extension geometry and typical sections (SW-300's).

In addition to PBOT and Fire Bureau requirements, existing utility locations may also impact allowable curb extension width. It may be necessary to reduce the width of a curb extension to avoid a utility conflict.

Curb extensions must be designed with a wheel stop at the inlet/outlet of a facility when adjacent to on-street parking. Significant damage to both the facility and a vehicle can occur if a vehicle enters the curb opening of a curb extension. See [Section 2.3.5](#).

Generally, a minimum length of 30 feet is required to accommodate a mid-block curb extension ranging from 4 to 6 feet in width. Any linear length shorter than this should not be considered for a curb extension.

Existing sidewalks with a vertical or horizontal displacement greater than or equal to ½ inch must be repaired at locations where new construction meets old as shown on the [City of Portland Standard Construction Specifications Drawing P-554](#). Many existing sidewalks are old and not able to withstand even minimal adjacent disturbance or construction loads. Since the adjacent property owner is responsible under City Code for sidewalk maintenance and repair, the sidewalk must be restored to a condition as good as the condition that existed before construction. Replacement of fragile sidewalks beyond the minimal requirements allowed by [P-554](#) should be evaluated during the design process by PBOT staff.

Figure 2-12. Street Widths for Curb Extensions

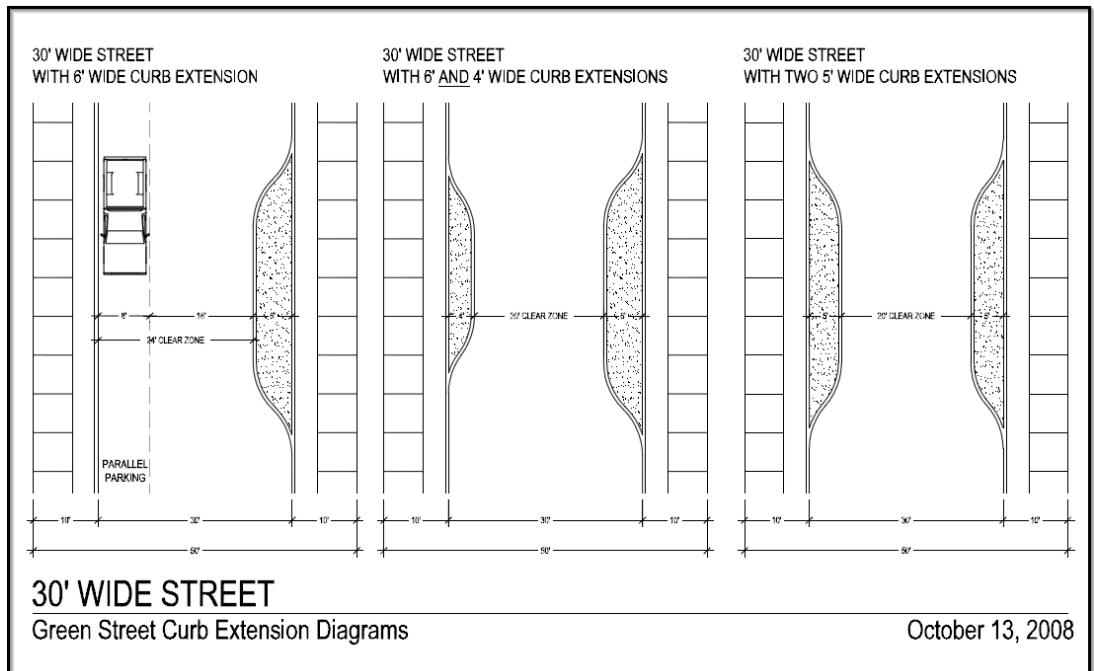
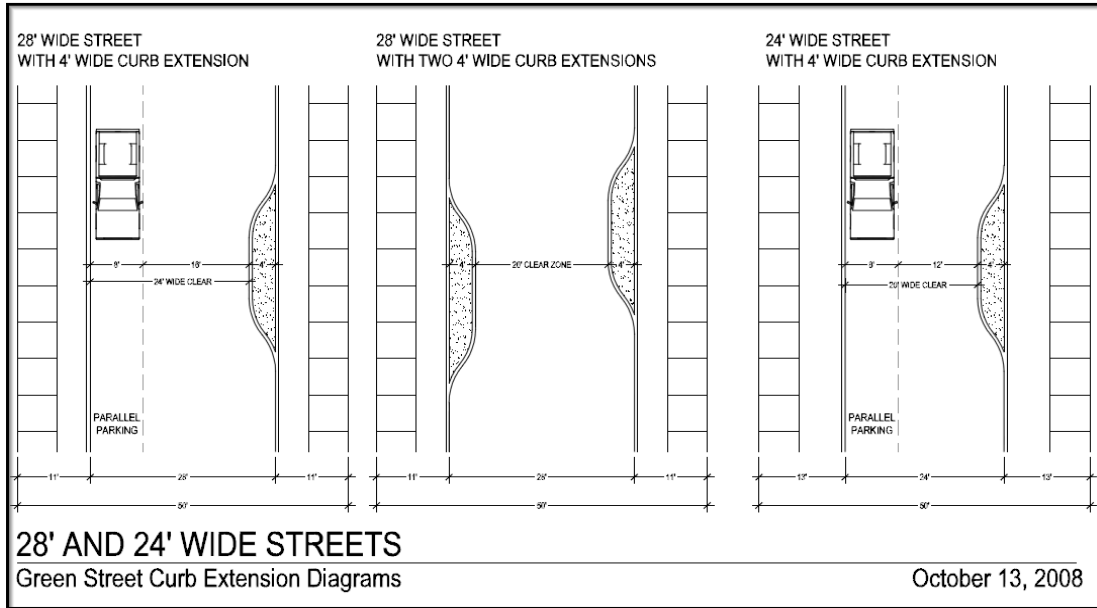

32 feet and wider streets may have up to 6 feet curb extensions on one or both sides of the street.

Stormwater Requirements

Soil suitability: Existing infiltration rates will determine if the facility can be designed to achieve infiltration, partial infiltration, or allow the stormwater to be conveyed through the facility. See [Section 2.3.6](#) for infiltration testing procedures and requirements.

Setbacks: Infiltration curb extensions are typically set back 10 feet from building foundations. There are no setback requirements for lined curb extensions. See Table 2-1 for more information on setbacks.

Sizing: Surface area and depth of facility vary. The Presumptive Approach Calculator (PAC) allows the designer to size stormwater facilities with respect to native infiltration rates and other unique site conditions of the project. Under the PAC, a curb extension can be designed as a swale or planter facility type depending on site conditions and design needs.

Dimensions and slopes: The minimum curb extension width is 4 feet, and the length will vary. They may vary in ponding depth from 6 to 9 inches measured from the inlet elevation. Maximum longitudinal slope is 6 percent.

Liners: Full or partial liners may be required for protecting adjacent water facilities/utilities, on higher classification streets, in locations with hazardous materials or topography considerations, and in wellhead protection areas. The location determines the required liner thickness, see below. All liners must be attached per the Green Street details in [Section 2.3.5](#). Other methods may be considered where impervious or waterproof facilities are required, such as single-pour concrete forms.

- 30 mil HDPE – water main and road protection.
- 40 mil HDPE – Southshore Well Field Wellhead Protection Area.

Piping: 8-inch ASTM 3034 SDR 35 PVC pipe and 4-inch perforated pipe are required. Refer to the City's [Sewer and Drainage Facilities Design Manual](#).

Check dams: Check dams may be required perpendicular to the flow line to encourage water to pool and infiltrate into the ground. Locate check dams as per Presumptive Approach Calculator to maximize volume. See [Section 2.3.5](#) for Green Street check dam typical details.

Drainage layer: 1 ½" - ¾-inch round washed drain rock may be required per PAC calculations. Drain rock and growing medium must be separated a 2-inch to 3-inch layer of ¾-inch to No. 4 open graded aggregate. Geotextile fabric is prohibited.

Growing medium: For curb extensions, the growing medium is specified in [Section 2.3.6](#). The blended soil must be 18 inches deep, or less if native soils drain well.

Vegetation: The entire facility area must be planted with vegetation. The facility area is equivalent to the total area of the facility, including bottom and side slopes, as developed in the sizing calculations. Curb extensions should be planted so they do not block traffic sight lines or require mowing. See [Section 2.4.1](#) for suggested plant material appropriate for private property and required material for the public right-of-way. See [Section 2.3.5](#) for typical details and planting templates.

Use planter vegetation requirements for flat bottom curb extensions. Use swale vegetation requirements for curb extensions with side slopes.

Mulch: Requirements vary by location.

Private property requirements: Fine to medium hemlock mulch is recommended for curb extensions. It should be placed in the facility only in areas above the high-water line. Care should be given to keeping mulch material out of a stormwater flow path to avoid any material from clogging inlets or outlets or otherwise escaping the facility. It must be weed-free and applied 2 to 3 inches thick to cover all soil between plants. It should not be over-applied.

Right-of-way requirements: Mulch may be allowed by BES on a case-by-case basis. Mulch will only be allowed on facilities with side slopes that do not have an aboveground overflow drain. Mulch must not inhibit water flow in the flow path, inlets, or outlets. Mulch material must be fine to medium 100% hemlock bark free of dyes and pesticides. Mulch must be applied after beds are clear of weeds and debris, after planting and watering-in of new plants is complete and after the soil surface is brought to a smooth, finished grade. Mulch must be applied in planted areas to an even, uniform depth of 2 inches. Keep mulch off plants, structures, roadways, shoulders, walks, and lawns. Mulch must not cover herbaceous plants or come into contact with the stems of woody shrubs or trees. Mulch surface must be left with a smooth, finished appearance as approved by the City.

Typical Details: See [Section 2.3.5](#) for typical details for curb extensions designed as Green Streets in the public-right-of-way (SW-300's).

Submittal Requirements

See [Section 2.4](#) for submittal requirements for the design specific approach.

Construction Considerations

Infiltration curb extension areas should be clearly marked before site work begins to avoid soil compaction or sedimentation during construction. No vehicular or foot traffic, except that specifically used to construct the facility, should be allowed within 10 feet of infiltration curb extension areas.

2.3.4.8. Planters



Planters infiltrate or treat stormwater; this planter is monolithically poured concrete in a commercial setting.

Facility Description

Planters are structural landscaped reservoirs used to collect, filter, and infiltrate stormwater, allowing pollutants to settle and filter out as the water percolates through the vegetation, growing medium, and gravel. Depending on site conditions, planters can be designed to completely or partially infiltrate the stormwater they receive. They can also be designed as lined facilities where stormwater is temporarily stored. Excess stormwater collects in a perforated pipe at the bottom of the lined planter and drains to an approved discharge location. Planters can be used to help fulfill a site's required landscaping area requirement and should be integrated into the overall site design. Numerous design variations of shape, wall treatment, and planting scheme can be used to fit the character of a site. Because lined planters can be constructed immediately next to buildings, they are ideal for sites with setback requirements, poorly draining soils, steep slopes, or other constraints.

Design Requirements

Soil suitability: Existing infiltration rates and design approach will determine if the facility can be designed to achieve infiltration, partial infiltration, or might be lined. See [Section 2.3.6](#) for infiltration testing procedures.

Simplified Approach: If the tested infiltration rate is greater than or equal to 2 inches per hour, the simplified planter design meets all requirements. If the tested infiltration rate is less than 2 inches per hour, the planter should be designed as a partial infiltration or lined facility, with an overflow to an approved discharge location.

Setbacks: Requirements vary by location.

Private property requirements: Infiltration planters are typically set back 5 feet from property lines and 10 feet from building foundations. No setbacks are required for lined planters where the height above finished grade is 30 inches or less. Lined planters can be used next to foundation walls, adjacent to property lines, or on slopes when they include a waterproof lining. See Table 2-1 for more information on setbacks.

Right-of-way requirements: If a basement is within 10' of an infiltration planter, a partial liner may be required on the basement side of the planter.

Sizing: Requirements vary by design approach.

Simplified Approach: A sizing factor of 0.06 is required.

Presumptive Approach: The Presumptive Approach Calculator allows the designer to size stormwater facilities with respect to native infiltration rates and other unique site conditions of the project.

Performance Approach: Must be engineered to meet site-specific stormwater requirements.

Dimensions and slopes: Requirements vary by location and design approach.

Simplified Approach requirements: The minimum planter width is 24 inches (measured from inside the planter walls). Facility storage depth must be at least 12 inches (from inlet elevation of overflow to top of growing medium), unless a larger-than-required planter area is specified. Planters are flat facilities that must not slope more than 0.5 percent in any direction. A minimum of 2 inches of freeboard (vertical distance between the design water surface elevation and overtopping elevation) must be provided.

Private property requirements for Presumptive Approach: The minimum planter width is 24 inches (measured from inside the planter walls). Facility storage depth must be per PAC calculations. Planters are flat facilities that must not slope more than 0.5 percent in any direction. A minimum of 2 inches of freeboard (vertical distance between the design water surface elevation and overtopping elevation) must be provided.

Right-of-way requirements: The minimum width for a planter is 30 inches. They may vary in ponding depth from 6 to 9 inches measured from the inlet elevation. The maximum longitudinal slope is 6%. If parking is adjacent to the facility, the maximum length is 20 feet.

Planter walls: Requirements vary by location and design approach.

Private property requirements: Planter walls must be concrete unless otherwise approved. For planters that require an impervious bottom, a monolithically poured planter without joints is required.

Right-of-way requirements: See [Section 2.3.5](#) for Green Street typical details for planter wall requirements.

Waterproofing/Liner: Requirements vary by location.

Private property requirements: Lined facilities that require an impervious bottom must be a single-pour concrete box, or approved equivalent.

Right-of-way requirements: Full or partial liners may be required for protecting adjacent water facilities/utilities, on higher classification streets, in locations with hazardous materials or topography considerations, and in wellhead protection areas. The location determines the required liner thickness, see below. All liners must be attached per the Green Street details in [Section 2.3.5 Typical Details](#). Other methods may be considered where impervious or waterproof facilities are required, such as single-pour concrete forms.

- 30 mil HDPE – water main and road protection.
- 40 mil HDPE – Columbia Southshore Well Field Wellhead Protection Area.

Piping: Requirements vary by location.

Private property requirements: Piping must be cast iron, ABS SCH40, or PVC SCH40. Three-inch pipe is required for facilities draining up to 1,500 square feet of impervious area; otherwise, a 4-inch pipe minimum is required. Piping installation must follow current Uniform Plumbing Code.

Right-of-way requirements: 6-inch or 8-inch ASTM 3034 SDR 35 PVC pipe and perforated pipe are required. Refer to the City's [Sewer and Drainage Facilities Design Manual](#) for more information.

Drainage Layer: Requirements vary by location and design approach.

Simplified Approach requirements: 12" depth of ¾" – 1 ½" washed drain rock must be used. Drain rock and growing medium must be separated by a 2- to 3-inch layer of pea gravel.

Private property requirements Presumptive Approach: Determined by designer and PAC calculations. Options include, but are not limited to drain mat, ¾" washed rock, or other approved system. Separation between growing medium and drainage layer may be appropriate filter fabric or a gravel lens (pea gravel 2 to 3 inches deep), or as per approved design.

Right-of-way requirements: 1 ½" - ¾-inch round washed drain rock may be required per PAC calculations. Drain rock and growing medium must be separated a 2-inch to 3-inch layer of ¾-inch to No. 4 open graded aggregate. Geotextile fabric is prohibited.

Check dams: Requirements vary by location and design approach.

Simplified and Presumptive requirements: Check dams are required for slopes over 0.5%.

Right-of-way requirements: Place check dams per PAC calculations to maximize volume. See [Section 2.3.5 \(SW-300's\)](#) for typical check dam details.

Growing medium: Requirements vary by location.

Private property requirements: The imported soil must be a sandy loam mixed with compost or a sand/soil/compost blend. It must be roughly one-third compost by volume, free-draining, and support plant growth. The compost must be derived from plant material; animal waste is not allowed. The Stormwater Facility Blended Soil for public facilities is also acceptable, see [Section 2.3.6](#).

If a stormwater management facility is proposed adjacent to property lines or nearby structures, then a lined facility will likely be required. Vegetation planted within water-tight stormwater management facilities cannot compromise the integrity of the facility liner and the facility design must ensure plants will survive. The applicant must coordinate with BES and BDS staff regarding applying BES Stormwater Management Manual requirements, while meeting landscaping

requirements. To provide adequate area for plants to grow, vegetation must be planted within a minimum growing medium depth of 24 inches.

Right-of-way requirements: For streets, the Stormwater Facility Blended Soil is specified in [Section 2.3.6](#). The imported growing material must be 18 inches deep, or less if native soils drain well.

Vegetation: Requirements vary by location.

Private property requirements: The entire facility area must be planted with vegetation as per Figure 2-13. The facility area is equivalent to the total area of the planter, as developed in the sizing calculations. The entire surface area of a planter is inundated with water and therefore requires only Zone A plants. See [Section 2.4.1](#) for suggested plant material.

Figure 2-13. Planter Vegetation - Zone A

Number of Plants	Vegetation Type	Per square feet	Size	Spacing density (on center)
80	Herbaceous plants	100	#1 container	1.25'
OR				
72	Herbaceous plants	100	#1 container	1.25'
4	Small Shrubs	100	#1 container	1'

Note: Tree planting is not required in planters but is encouraged where practical. Tree planting is also encouraged near planters.

Right-of-way requirements: See [Section 2.3.5](#) for typical Green Street details (SW-300's) and planting templates and [Section 2.4.1](#) for the Plant List for Public Stormwater Facilities. Plantings adjacent to streets require special attention to line-of-site and maintenance issues. Vegetation should be planted so it does not block traffic sight lines or require mowing. No medium to large shrubs are allowed. Minimum container size is #1 container. Plants to be spaced per the Plant List for Public Stormwater Facilities in [Section 2.4.1](#) and requirements on drawing [SW-362](#).

Mulch: Requirements vary by location.

Private property requirements: 2 to 3 inches deep medium hemlock mulch or approved equal.

Right-of-way requirements: Do not apply mulch.

Typical Details: See [Section 2.3.5](#) for typical details for planters designed under the Simplified Approach (SW-100's), the Presumptive Approach on private property (SW-200's) and for vegetated stormwater facilities in the public-right-of-way (SW-300's).

Submittal Requirements

See [Section 2.4](#) for submittal requirements for the design specific approach.

Construction Considerations

Special attention should be paid to the structural waterproofing if the planter is constructed adjacent to building structures. Infiltration planter areas should be clearly marked before site work begins to avoid soil compaction and sedimentation to preserve infiltration capacity during construction. No vehicular or foot traffic, except that specifically used to construct the facility, should be allowed within 10 feet of infiltration planter areas.

2.3.4.9. Basins



Basins are shallow landscape depressions which treat and infiltrate runoff.

Facility Description

Vegetated infiltration basins are shallow landscaped depressions used to collect and hold stormwater runoff, allowing pollutants to settle and filter out as the water infiltrates into the ground. Basins are also referred to as rain gardens. They are either excavated or created with bermed side slopes. An inlet pipe or sheet flow over impervious area conveys the stormwater into the basin, where it is temporarily stored until it infiltrates into the ground. Basins often provide complete onsite infiltration for small storm events. They can be sized to infiltrate large storms in areas where soils drain well or overflow to an approved discharge location. Basins can have a formal or informal design that can be used to help fulfill a site's landscape requirements.

Design Requirements

Soil suitability: Existing infiltration rates will determine if the facility can be designed to achieve infiltration, partial infiltration, or allow the stormwater to be conveyed through the facility. See [Section 2.3.6](#) for infiltration testing procedures.

Simplified Approach: If the tested infiltration rate is greater than or equal to 2 inches per hour, the simplified basin design meets all requirements. If the tested infiltration rate is less than 2 inches per hour, the basin should be designed as a partial infiltration facility, with an overflow to an approved discharge location.

Presumptive Approach: For the Presumptive Approach ([Section 2.2.2](#)), the existing infiltration rate also determines the type of basin, but additional variables are factored in to determine the configuration of the facility.

Setbacks: Requirements vary by location and design approach.

Private property requirements: Infiltration basins are typically set back 5 feet from property lines and 10 feet from building foundations. There are no setback requirements for lined basins. See Table 2-1 for more information on setbacks.

Right-of-way requirements: If a basement is within 10' of an infiltration basin, a partial liner may be required on the basement side of the basin.

Sizing: Requirements vary by location and design approach.

Simplified Approach: A sizing factor of 0.09 is required.

Presumptive Approach: The Presumptive Approach Calculator allows the designer to size stormwater facilities with respect to native infiltration rates and other unique site conditions of the project.

Performance Approach: Must be engineered to meet site-specific stormwater requirements.

Dimensions and slopes: Requirements vary by location and design approach.

Private property requirements: Minimum bottom width is 2 feet where feasible. Basins designed with the Simplified Approach are 12 inches deep measured from the top of the growing medium to the overflow inlet elevation. Basins designed with the Presumptive Approach vary in depth. Maximum side slopes are 3 horizontal to 1 vertical; 4 horizontal to 1 vertical is required immediately adjacent to pedestrian areas. A minimum of 2 inches of freeboard must be provided.

Right-of-way requirements: Minimum bottom width is 2 feet. A minimum of 2 inches of freeboard must be provided. The maximum ponding depth is 9", unless otherwise approved. See Green Street details in [Section 2.3.5](#) for side slope requirements.

Waterproofing/Geosynthetic Liner: Requirements vary by location and design approach.

Private property requirements: Liner must be 30-mil EPDM, HDPE, or approved equal.

Right-of-way requirements: Full or partial liners may be required for protecting adjacent water facilities/utilities, on higher classification streets, in locations with hazardous materials or topography considerations, and in wellhead protection areas. The location determines the required liner thickness, see below. All liners must be attached per the Green Street details in [Section 2.3.5](#). Other methods may be considered where impervious or waterproof facilities are required, such as single-pour concrete forms.

- 30 mil HDPE – water main and road protection.
- 40 mil HDPE – Columbia Southshore Well Field Wellhead Protection Area.

Piping: Requirements vary by location.

Private property requirements: Piping must be cast iron, ABS SCH40, or PVC SCH40. Three-inch pipe is required for facilities draining up to 1,500 square feet of impervious area; otherwise, a 4-inch pipe minimum is required. Piping installation must follow current Uniform Plumbing Code.

Right-of-way requirements: 6-inch or 8-inch ASTM 3034 SDR 35 PVC pipe and perforated pipe are required. Refer to the City's [Sewer and Drainage Facilities Design Manual](#) for more information.

Drainage Layer: Requirements vary by location and design approach.

Simplified Approach requirements: 12" depth of ¾" – 1 ½" washed drain rock must be used. Drain rock and growing medium must be separated a 2- to 3-inch layer of pea gravel.

Presumptive approach on private property requirements: Determined by designer and PAC calculations. Options include, but are not limited to drain mat, ¾" washed rock, or other approved system. Liner must be 30-mil EPDM, HDPE, or approved equal. Separation between growing medium and drainage layer may be appropriate

filter fabric or a gravel lens (pea gravel 2 to 3 inches deep), or as per approved design.

Right-of-way requirements: 1 ½" - ¾-inch round washed drain rock may be required per PAC calculations. Drain rock and growing medium must be separated a 2-inch to 3-inch layer of ¾-inch to No. 4 open graded aggregate. Geotextile fabric is prohibited.

Growing medium: Requirements vary by location.

Private property requirements: The imported soil must be a sandy loam mixed with compost or a sand/soil/compost blend. It must be roughly one-third compost by volume, free-draining, and support plant growth. The compost must be derived from plant material; animal waste is not allowed. The Stormwater Facility Blended Soil for public facilities is also acceptable, see [Section 2.3.6](#).

If a stormwater management facility is proposed adjacent to property lines or nearby structures, then a lined facility will likely be required. Vegetation planted within water-tight stormwater management facilities cannot compromise the integrity of the facility liner and the facility design must ensure plants will survive. The applicant must coordinate with BES and BDS staff regarding applying BES Stormwater Management Manual requirements, while meeting landscaping requirements. To provide adequate area for plants to grow, vegetation must be planted within a minimum growing medium depth of 24 inches.

Right-of-way requirements: For streets, the Stormwater Facility Blended Soil is specified in [Section 2.3.5](#). The imported growing material must be 18 inches deep, or less, if native soils drain well.

Vegetation: The entire facility area must be planted with vegetation. The facility area is equivalent to the total area of the basin, including bottom and side slopes, as developed in the sizing calculations. See [Section 2.4.1](#) for suggested plant material appropriate for private property and required plant material for the public right-of-way. Basins should be designed so they do not require mowing.

Private property requirements: The entire facility area must be planted with vegetation as per quantities in Figure 2-14 and Figure 2-15. The facility area is equivalent to the total area of the basin, including bottom and side slopes, as developed in the sizing calculations. See [Section 2.4.1](#) for suggested plant material appropriate for private property. Basins should be designed so they do not require mowing.

Figure 2-14. (Private Property) Basin Vegetation - Zone A

Number of Plants	Vegetation Type	Per square feet	Size	Spacing density (on center)
80	Herbaceous plants	100	#1 container	1.25'
OR				
72	Herbaceous plants	100	#1 container	1.25'
4	Small shrubs	100	#1 container	1'

Figure 2-15. (Private Property) Basin Vegetation - Zone B

Number of Plants	Vegetation Type	Per square feet	Size	Spacing density (on center)
7	Large to small shrubs	100	#2 container	2'
70	Groundcover	100	#1 container	1'

If the total project area is over 200 square feet consider adding a tree and reducing the number of herbaceous plants and shrubs.

Right-of-way requirements: See [Section 2.3.5](#) for typical Green Street details and planting templates and [Section 2.4.1](#) for Plant List for Public Stormwater Facilities. Plantings adjacent to streets require special attention to line-of-site and maintenance issues. Vegetation should be planted so it does not block traffic sight lines or require mowing. No medium to large shrubs are allowed. Minimum container size is #1 container. Plants to be spaced per Plant List for Public Stormwater Facilities in [Section 2.4.1](#) and requirements on drawing [SW-362](#).

Mulch: Requirements vary by location.

Private property requirements: Fine to medium hemlock bark is recommended for basins. It should be placed in the facility only in areas above the high-water line. Care should be given to keeping mulch material out of a stormwater flow path to avoid any material from clogging inlets or outlets or otherwise escaping the facility. It must be weed-free and applied 2 to 3 inches thick to cover all soil between plants. It should not be over-applied.

Right-of-way requirements: Mulch may be allowed by BES on a case-by-case basis. Mulch will only be allowed on facilities with side slopes that do not have an aboveground overflow drain. Mulch must not inhibit water flow in the flow path, inlets, or outlets. Mulch material must be fine to medium 100% hemlock bark free of dyes or pesticides. Mulch must be applied after beds are clear of weeds and debris, after planting and watering-in of new plants is complete and after the soil surface is brought to a smooth, finished grade. Mulch must be applied in planted areas to an even, uniform depth of 2 inches. Keep mulch off plants, structures, roadways, shoulders, walks, and lawns. Mulch must not cover herbaceous plants or come into contact with the stems of woody shrubs or trees. Mulch surface must be left with a smooth, finished appearance as approved by the City.

Typical Details: See [Section 2.3.5](#) for typical details for basins designed under the Simplified Approach (SW-100's), the Presumptive Approach on private property (SW-200's), and for Green Streets in the public-right-of-way (SW-300's).

Submittal Requirements

See [Section 2.4](#) for submittal requirements for the design specific approach.

Construction Considerations

Infiltration basin areas should be clearly marked before site work begins to avoid soil compaction or sedimentation during construction. No vehicular or foot traffic, except that specifically used to construct the facility, should be allowed within 10 feet of infiltration basin areas.

2.3.4.10. Filter Strips



Filter strips are gently-sloped vegetated areas which manage runoff from driveways and walkways, slowing the runoff and allowing it to infiltrate.

Facility Description

Vegetated filter strips are gently sloped areas that are designed to receive sheet flows. They are typically linear facilities that run parallel to the impervious surface and are commonly used to receive the runoff from walkways and driveways. Filter strips are covered with vegetation, including grasses and groundcovers, which filter and reduce the velocity of the stormwater. As the stormwater travels downhill, it infiltrates into the soils below.

Driveway center filter strips are used between the drive aisles of residential driveways. They are typically 3 feet wide and placed between two 3-foot-wide paved sections. (The minimum width of a residential driveway is 9 feet, of which the inner 3-foot section could be pervious and used for infiltration as long as all other code requirements are met.) The strip is used exclusively to treat and infiltrate the

stormwater from the impervious area of the drive aisles. The drive aisles must be sloped toward the driveway center filter strip. The driveway center filter strip must be maintained to the required design requirements (including 100 percent landscaping coverage) stated below.

Design Requirements

Soil Suitability: Filter strips are appropriate for all soil types.

Setbacks: Filter strips are typically 5 feet from the property line; 10 feet from buildings; and 50 feet from wetlands, rivers, streams, and creeks. See Table 2-1 for more information on setbacks.

Sizing: Where the Simplified Approach is applicable, the filter strip is sized at 20 percent of impervious area treated for a maximum of 500 square feet of impervious area to be managed by the filter strip. If the Simplified Approach cannot be used, the Performance Approach will be required for sizing the filter strip, with demonstration of infiltration feasibility.

Dimensions and slopes: Filter strips must slope between 0.5 and 6 percent. Slope of pavement area draining to the strip must be less than 6 percent. Filter strips must have a minimum length of 5 feet, measured in the direction of the flow.

Level spreaders: A grade board or sand/gravel trench may be required to disperse the runoff evenly across the filter strip. The top of the level spreader must be horizontal and at an appropriate height to provide sheet flow directly to the soil without scour. Level spreaders must not hold a permanent volume of runoff. Grade boards can be made of any material that will withstand weather and solar degradation. Trenches used as level spreaders can be filled with washed crushed rock, pea gravel, or sand.

Check dams: If necessary, check dams must be constructed of durable, nontoxic materials such as rock or brick or graded into the native soils. Check dams must be 3 to 5 inches high, and be perpendicular to the flow.

Growing medium: For filters designed with the Simplified Approach or filters on private property, the imported soil must be a sandy loam mixed with compost or a sand/soil/compost blend. It must be roughly one-third compost by volume, free-draining, and support plant growing. The compost must be derived from plant material; animal waste is not allowed. The growing medium must be 12 inches deep for filter strips.

Vegetation: The entire filter strip must have 100 percent coverage by grasses, ground covers, or any combination thereof. See [Section 2.4.1](#) for plant lists.

Typical Details: See [Section 2.3.5](#) for typical details for filter strips (vegetated filters) designed under the Simplified Approach (SW-100's).

Submittal Requirements

See [Section 2.4](#) for submittal requirements for the design specific approach.

2.3.4.11. Grassy Swales

Facility Description

Grassy swales are long, narrow grassy depressions used to collect and convey stormwater runoff, allowing pollutants to settle and filter out as the water infiltrates into the ground or flows through the facility. In addition to providing pollution reduction, they can also manage flow rates and volumes. Grassy swales should be integrated into the overall site design and can be used to help fulfill a site's required landscaping area requirement.

Grassy swales must be designed and submitted under the Performance Approach (see [Section 2.2.3](#)) to meet the site-specific stormwater requirements outlined in [Chapter 1](#).

Design Requirements

Soil suitability: Grassy swales are appropriate for all soil types.

Setbacks: Grassy swales are typically set back 5 feet from centerline of the swale to property lines and 10 feet to building foundations, unless the swale is lined with impermeable fabric. See Table 2-1 for more information on setbacks.

Sizing: The Simplified Approach and Presumptive Approach are not available to size grassy swales. The Performance Approach must be used to meet the below criteria.

The swale width and profile must be designed to convey runoff from the pollution reduction design storm intensity at:

- Maximum design velocity of 0.9 feet per second.
- Minimum hydraulic residence time (time for Q_{design} to pass through the swale) of 9 minutes.
- A Manning n value of 0.25.

A maximum ponding depth of 4" is required to maximize contact with the grass, unless otherwise approved.

A minimum of 1 foot of freeboard above the water surface must be provided for facilities not protected by high-flow storm diversion devices. Swales without high-flow diversion devices must be sized to safely convey the 25-year storm event, analyzed using the Rational Method (peak 25-year, 5 minute intensity = 3.32 inches per hour).

Velocity through the facility must not exceed 3 feet per second during the high-flow events (i.e., when flows greater than those resulting from the pollution reduction design intensity are not passed around the facility).

Figure 2-16, Figure 2-17 and Figure 2-18 are derived from the [City's Sewer and Drainage Facilities Design Manual](#) to determine minimum required swale length and the swale bottom width given the peak flow rate.

Figure 2-16. Swale Length at 1.5% Longitudinal Slope

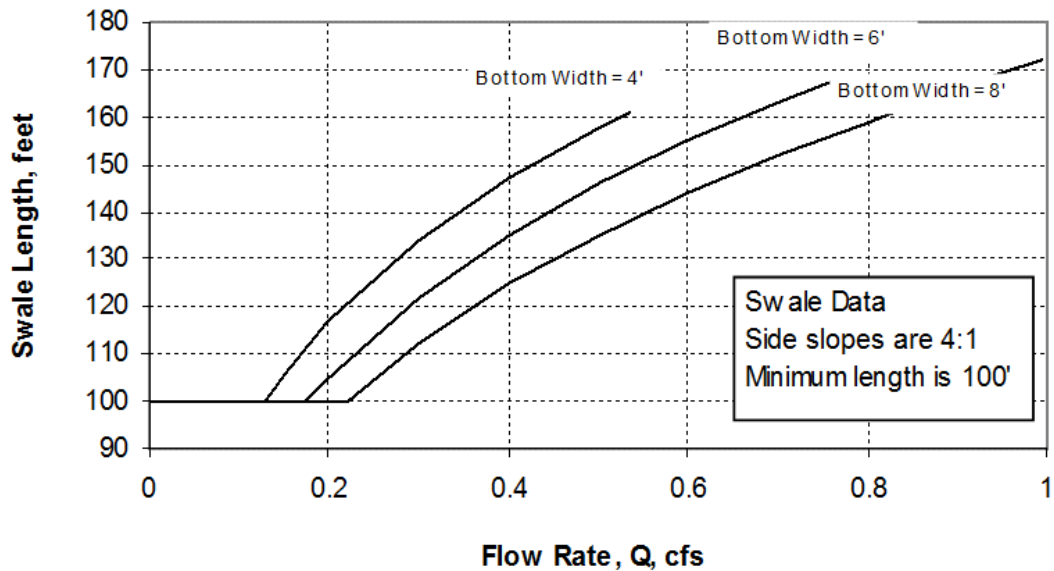

Figure 2-17. Swale Length at 3.0% Longitudinal Slope

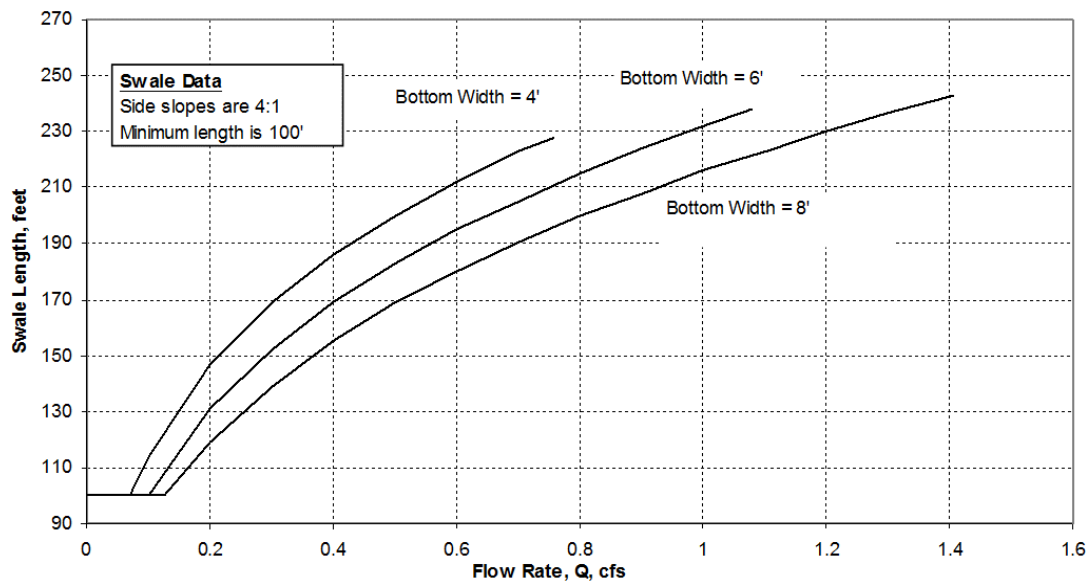
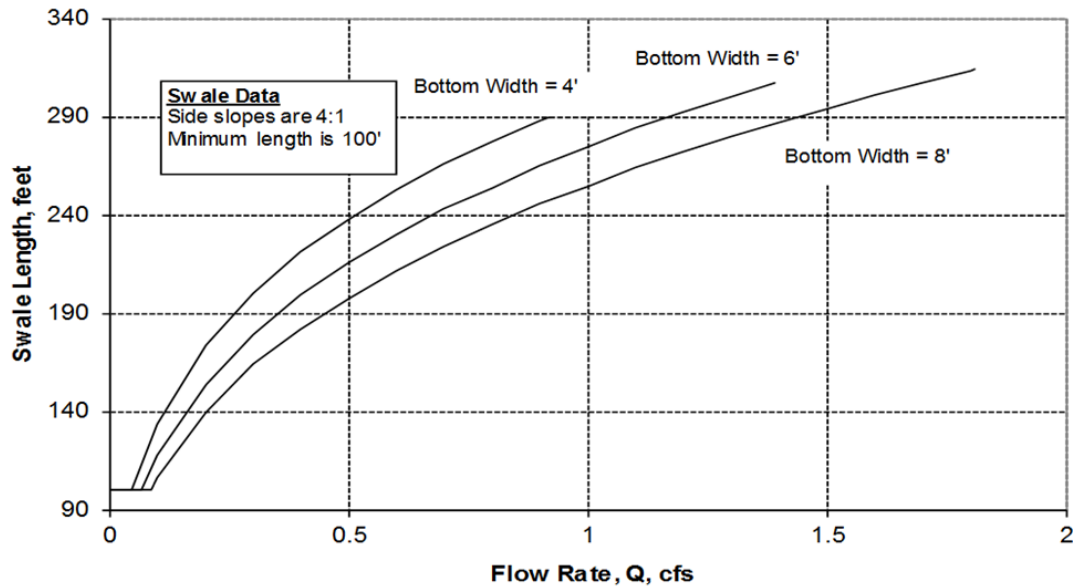

Figure 2-18. Swale Length at 5.0% Longitudinal Slope



Dimensions and slopes: The minimum grassy swale width on private property is 10 feet, with a minimum 2-foot flat bottom. The minimum grassy swale width on public property is 12 feet, with a minimum 4-foot flat bottom. Maximum side slopes for both are 4 horizontal to 1 vertical. The minimum length for both is 100 feet.

When designing grassy swales, slopes and depth should be kept as mild as possible to avoid safety risks and prevent erosion within the facility. To minimize flow channelization, the grassy swale bottom must be smooth, with uniform longitudinal slope. Maximum surrounding ground slopes must not exceed 10 percent.

Flow spreader: The grassy swale must incorporate a flow-spreading device at the inlet. The flow spreader must provide a uniform flow distribution across the swale bottom. In swales with a bottom width greater than 6 feet, a flow spreader must be installed at least every 50 feet.

Check dams: Per design.

Growing medium: Blended topsoil must be used within the top 18 inches of the facility to support plant growth, per specifications in [Section 2.3.6](#).

Vegetation: Grasses must be established as soon as possible after the swale is completed and before water is allowed to enter the facility. Unless vegetation is established prior to completion of construction, biodegradable erosion control matting appropriate for low-velocity flows (approximately 1 foot per second) must

be installed in the flow area of the swale before water is allowed to be conveyed through the swale. Figure 2-19 shows vegetation requirements for grassy swales.

Figure 2-19. (Private Property) Grassy Swale Vegetation

Number of Plants	Vegetation Type	Per square feet	Size	Spacing density (on center)
1	Evergreen Tree	200	Min 6' height	
OR				
1	Deciduous Tree	200	1 ½" caliper at 6" above base	
AND				
100% Native or swale seed mix coverage				(completely cover bottom and side slopes)

For the swale flow path, approved native grass mixes are preferable. Seed must be applied at the rates specified by the supplier. Plants must be established at the time of facility completion (at least 3 months after seeding). Trees and shrubs may be allowed in the flow path within swales if the swale exceeds the minimum length and widths specified. See [Section 2.4.1](#) for more information on trees and shrubs that are appropriate.

Native wildflowers and grasses used for BES-maintained facilities must be designed to not require mowing. Where mowing cannot be avoided, facilities must be designed to require mowing no more than once or twice annually. Lawn-type areas are not allowed for BES-maintained facilities; any exceptions require BES approval. Grassy swales in environmental zones must meet requirements established by Title 33 for grass species in Environmental Zones.

Submittal Requirements

See [Section 2.4](#) for submittal requirements for the design specific approach.

Construction Considerations

Infiltration areas should be clearly marked before site work begins to avoid soil compaction or sedimentation during construction. No vehicular or foot traffic, except that specifically used to construct the facility, should be allowed within 10 feet of infiltration areas.

No concentrated flows are allowed into the facility until the vegetation is fully established.

2.3.4.12. Ponds

Facility Description

Three types of ponds are described in this section: wet ponds, extended wet ponds, and dry ponds, all of which must be designed and submitted under the Performance Approach (see [Section 2.2.3](#)) to meet the site-specific stormwater requirements.

The City encourages pond design to provide multipurpose benefits (e.g., parks, open space, or recreation facilities), provided that any alternative uses are compatible with the primary stormwater functions and maintenance standards.

Wet ponds are constructed with a permanent pool of water (commonly referred to as pool storage or dead storage). Stormwater enters the pond at one end and displaces water from the permanent pool. Pollutants are removed from stormwater through gravitational settling and biological processes. When the sizing criteria presented in this section are used, pollution reduction requirements are presumed to be met. Additional facilities may be required in order to meet flow control requirements, as applicable.

Extended wet ponds are also constructed with a permanent pool of water, but have additional storage above that fills during storm events and releases water slowly over a number of hours. The permanent pool is sized to provide pollution reduction, and the additional storage above (extended detention area) is sized to meet flow control requirements. Pollutants are removed from stormwater through gravitational settling and biological processes. When the sizing criteria presented in this section are used, pollution reduction requirements are presumed to be met. The extended detention must be designed using acceptable hydrologic modeling techniques (see [Section 2.2.3](#) Performance Approach) to meet applicable flow control requirements.

Dry detention ponds are designed to fill during storm events and slowly release the water over a number of hours. Dry detention ponds must be designed using acceptable hydrologic modeling techniques (see [Section 2.2.3](#) Performance Approach) to meet applicable flow control requirements. Additional facilities are required in order to meet pollution reduction requirements, unless the bottom flow path of the pond is designed as a swale according to the swale sizing and design criteria.

Design Requirements

Location and Ownership: All open ponds to be maintained by the City of Portland must be located in a separate open space tract with public sewer easements dedicated to the City.

Open ponds serving more than one tax lot or designed to function as multi-use/recreational facilities must be located in a separate tract (e.g., Tract A), defined easement, or designated open space.

Instream ponds are not allowed.

Soil Suitability: Detention ponds are appropriate for sites with slow draining soils (less than 2"/hour tested) or for facilities that are fully lined. Sites with well-draining soils (at or over 2"/hour tested) should consider the use of an infiltration basin.

Setbacks: Ponds are typically constructed to maintain the following setback distances from structures and other facilities. (All distances are measured from the edge of the maximum water surface elevation.) See Table 2-1 for more information on Setbacks.

- Minimum distance from the edge of the pond water surface to property lines and structures: 20 feet, unless an easement with adjacent property owner is provided.
- Distance from the toe of the pond berm embankment to the nearest property line: one-half of the berm height (minimum distance of 5 feet).
- Minimum distance from the edge of the pond water surface to septic tank, distribution box, or septic tank drain field: 100 feet.
- Surrounding slopes must not exceed 10 percent. Minimum distance from the edge of the pond water surface to the top of a slope greater than 15 percent: 200 feet, unless a geotechnical report is submitted and approved by BES.
- Minimum distance from the edge of the pond water surface to a well: 100 feet.

Access: Access routes to the pond for maintenance purposes must be shown on the plans. Public ponds must provide a minimum 12-footwide access route, not to exceed 10 percent in slope. An eight-foot wide access route is allowed with approval.

Sizing:

- Wet and extended wet detention ponds should be designed for large drainage areas (5 to 150 acres) to help avoid problems associated with long periods of stagnant water.
- For wet and extended wet detention ponds, a water budget must be submitted for review. The water budget must demonstrate that the base flow to the pond is sufficient such that water stagnation/alga matting will not become a problem.
- Wet and extended wet detention permanent pool sizing: The permanent pool (or dead) storage volume, V_{pond} , is equivalent to twice the runoff volume generated by a storm of 0.83 inch over 24 hours (NRCS Type 1A rainfall distribution). This volume can be approximated using the following formula:

$$\text{Volume} = 2 \times (2,276 \times \text{Impervious Acreage})$$

Where Volume = permanent pool volume, cubic feet and Impervious Acreage = area of impervious surfaces to manage, acres

Flow control for extended wet detention and dry detention ponds: To restrict flow rates exiting the pond to those required by [Section 1.3](#), a control structure must be used. For extended wet detention ponds, this control structure must be located above the permanent pool elevation. The outlet orifice must be designed to minimize clogging.

Note: Because of minimum orifice size requirements (2 inches for public facilities, 1 inch for private facilities), detention facilities that rely on orifice structures to control flows for small projects (under 15,000 square feet of impervious development footprint area) are not allowed.

Control structure design: Weir and orifice structures must be enclosed in a catch basin, manhole, or vault and must be accessible for maintenance.

The control structure must be designed to pass the 100-year storm event as overflow, without causing flooding of the contributing drainage area.

The methods and equations for the design of flow-restricting control structures, for use with extended wet detention ponds, and dry detention ponds are below.

Orifices: Orifices may be constructed on a “tee” riser section.

The minimum allowable diameter for an orifice used to control flows in a public improvement is 2 inches. Private facilities may use a 1-inch-diameter orifice if additional clogging prevention measures are implemented. The orifice diameter must always be greater than the thickness of the orifice plate.

Multiple orifices may be necessary to meet the 2- through 25-year design storm performance requirements for a detention system. However, extremely low flow rates may result in the need for small orifices (< 1 inch for private facilities, < 2 inches for public) that are prone to clogging. In these cases, retention facilities that do not rely on orifice structures must be used to the maximum extent practicable to meet the site-specific flow control requirements. Large projects may also result in high flow rates that necessitate excessively large orifice sizes that are impractical to construct. In such cases, several orifices may be located at the same elevation to reduce the size of each individual orifice.

Orifices must be protected within a manhole structure or by a minimum 18-inch-thick layer of 1½- to 3-inch evenly graded, washed rock. Orifice holes must be externally protected by stainless steel wire screen (hardware cloth) with a mesh of ¾ inch or less. Chicken wire must not be used for this application.

Orifice diameter must be greater than or equal to the thickness of the orifice plate.

Orifices less than 3 inches must not be made of concrete. A thin material (e.g., stainless steel, HDPE, or PVC) must be used to make the orifice plate; the plate must be attached to the concrete or structure.

Orifice Sizing Equation:

$$Q = CA \sqrt{2gh}$$

where:

Q = Orifice discharge rate, cubic feet per second (cfs)

C = Coefficient of discharge, feet (suggested value = 0.60 for plate orifices)

A = Area of orifice, square feet

h = hydraulic head, feet

g = 32.2 ft/sec²

The diameter of plate orifices is typically calculated from the given flow. The orifice equation is often useful when expressed as an equivalent orifice diameter in inches.

$$d = \sqrt{\frac{36.88 Q}{\sqrt{h}}}$$

where:

Q = flow, cfs

d = orifice diameter, inches

h = hydraulic head, feet

Rectangular Notched Sharp Crested Weir:

$$Q = C(L - 0.2H) * H^{1.5}$$

where:

Q= Weir discharge, cfs

C = 3.27 + 0.40×H/P, feet

P = Height of weir bottom above downstream water surface, feet

H = Height from weir bottom to crest, feet

L = Length of weir, feet*

* For weirs notched out of circular risers, length is the portion of the riser circumference not to exceed 50 percent of the circumference.

V-Notched Sharp Crested Weir:

$$Q = C_d \left(\tan \frac{\theta}{2}\right) H^{\frac{5}{2}}$$

where:

Q = Weir discharge, cfs

C_d = Contraction coefficient, feet (suggested value = 2.5 for 90 degree weir)

θ = Internal angle of notch, degrees

H = Height from weir bottom to crest, feet

Dimensions and slopes: Slopes and depth should be kept as mild as possible to avoid safety risks. Slopes within the pond must not exceed 3 horizontal to 1 vertical.

The maximum depth of the pond must not exceed 4 feet. The 0- to 2-foot depth must be distributed evenly around the perimeter of the pond.

The distance between all inlets and the outlet must be maximized to facilitate sedimentation. The minimum length-to-width ratio is 3:1, at the maximum water surface elevation. This ratio is critical to prevent “short-circuiting,” where water passes directly through the facility without being detained for any length of time. If area constraints make this ratio unworkable, baffles, islands, or peninsulas may be installed, with City approval, to increase the flow path and prevent short circuiting.

Minimum freeboard must be 1 foot above the highest potential water surface elevation (1 foot above the emergency overflow structure or spillway elevation).

Dry detention ponds must be divided into a minimum of two cells. The first cell (forebay) must contain approximately 10 percent of the design surface area and must provide at least 0.5 foot of dead storage for sediment accumulation.

Wet and extended wet detention ponds must be divided into a minimum of two cells. The first cell (forebay) must contain approximately 10 percent of the design surface area.

Outlet/overflow: If a riser pipe outlet is used, it must be protected by a trash rack and anti-vortex plate. If an orifice plate is used, it must be protected with a trash rack with at least 10 square feet of open surface area. In both cases, the rack must be hinged or easily removable to allow for cleaning. The rack must be adequately secured to prevent it from being removed or opened when maintenance is not occurring.

All ponds must have an emergency overflow spillway or structure designed to convey the 100-year, 24-hour design storm for post-development site conditions, assuming the pond is full to the overflow spillway or structure crest. The overflow must be designed to convey these extreme event peak flows around the berm structure for discharge into the downstream conveyance system. The overflow must be designed and sited to protect the structural integrity of the berm. This will ensure that catastrophic failure of the berm is avoided, property damage is avoided, and water quality of downstream receiving water bodies is protected.

The subgrade of the spillway must be set at or above the 100-year overflow elevation of the control structure. The spillway must be located to direct overflows safely toward the downstream conveyance system and must be located in existing soil wherever feasible. The emergency overflow spillway must be armored with riprap or other flow-resistant material that will protect the embankment and minimize erosion. Riprap must extend to the toe of each face of the berm embankment. The emergency overflow spillway weir section must be designed for

the maximum design storm event for post-development conditions, using the following formula:

$$L = \frac{Q_{100}}{3.21H^{1.5}} - 2.4 H$$

where:

- L = Length of bottom of weir, feet
- Q₁₀₀ = 100-year post-development flow rate, cfs
- H = Height of emergency overflow water surface, feet

Berm embankment/soil stabilization: Pond berm embankments must be designed by a civil engineer licensed in the State of Oregon.

Pond berm embankments must be constructed on native consolidated soil (or compacted and stable fill soil) that is free of loose surface soil materials, roots, and other organic debris. Topsoil is required over the consolidated soil to support required plantings.

Pond berm embankments must be constructed by excavating a key equal to 50 percent of the berm embankment cross-sectional height and width, measured through the center of the berm. The berm must be keyed into the native soil by excavating a trench below the berm. This keys the berm into the native soil and prevents it from sliding.

The berm embankment must be constructed of compacted soil (95 percent maximum dry density, Modified Proctor Method per ASTM D1557) placed in 6- to 8-inch lifts with hand-held equipment, or 10- to 12-inch lifts with heavy equipment.

Anti-seepage collars must be placed on outflow pipes in berm embankments that impound water greater than the designed depth of the pond. During construction, exposed earth on the pond side slopes must be seeded with appropriate seed mixture. Establishment of protective vegetative cover must be ensured with appropriate surface-protection best management practices (BMPs) and reseeded as necessary. See the [City of Portland's Erosion Control Manual](#).

Pond embankments must be constructed with a maximum slope of 3H: 1V on the upstream and downstream face. Side slopes within the pond must be sloped no steeper than 3H: 1V. The use of retaining walls in ponds requires preapproval from BES. Retaining walls must not exceed one-third of the circumference of the pond.

Detailed structural design calculations must be submitted with every retaining wall proposal.

Pond berm embankments 6 feet or less in height (including freeboard), measured through the center of the berm, must have a minimum top width of 6 feet, or as recommended by a geotechnical engineer.

Where maintenance access is provided along the top of berm, the minimum width of the top of berm must be 15 feet.

Growing medium: Because pond grading generally requires the topsoil to be removed to form the basin shape of the pond, the resulting top layers of soil must to be amended, or topsoil must be brought back in to ready the soil for planting. Topsoil must be used within the top 12 inches of the facility, or the soil must be amended to support plant growth.

Vegetation: The planting design must minimize solar exposure of open water areas. Trees or other appropriate vegetation must be located around the east, south, and west sides of the facility to maximize shading. Reducing solar exposure has two benefits: it helps reduce heat gain in water before discharging to a receiving water, helping it maintain a healthy and aesthetic pond condition, reducing algae blooms and the potential for anaerobic conditions to develop.

The facility area is equivalent to the area of the pond, including bottom and side slopes, plus the 10-foot buffer around the pond. The emergent plant zone must be at least 25 percent of the total pond water surface area. Minimum plant material quantities are shown in Figure 2-20 and Figure 2-21.

Figure 2-20. Pond Vegetation - Emergent Plants

Number of Plants	Vegetation Type	Per square feet	Size	Spacing density (on center)
115	Wetland plants	100	6" plugs	1'
OR				
100	Wetland plants	100	6" plugs	1'
4	Small shrubs	100	#1 container	3'
OR				
100% seed coverage				

Figure 2-21. Pond Vegetation - Side Slopes and Buffers

Number of Plants	Vegetation Type	Per square feet	Size	Spacing density (on center)
1	Evergreen tree	300	Min 6' height	
OR				
1	Deciduous tree	300	1 ½" caliper at 6" above base	
AND				
4	Large shrubs	100	#3 container	4'

Wildflowers, native grasses, and groundcovers used for BES-maintained facilities must not require mowing. Where mowing cannot be avoided, facilities must be designed to require mowing no more than once or twice annually. Turf and lawn areas are not allowed for BES-maintained facilities; any exceptions require BES approval.

For plant selection, see [Section 2.4.1](#).

Fencing: Fences are required for all City-maintained ponds with a permanent or temporary pool greater than 18 inches deep, interior side slopes steeper than 3H: 1V, or any walls/bulkheads greater than 24 inches high. The design must address screening requirements for fencing. Fencing for privately owned facilities is at the discretion of the owner. The owner may use the criteria for City-maintained facilities.

For both private and City-maintained facilities, Title 33 may prohibit fencing or require screening in some locations. The designer is responsible for determining which sections of Title 33 apply to the project. If fencing is prohibited by Title 33, the designer may have to modify the facility or site design to provide an alternate means of securing the site (for example, reducing the depth of water or side slopes of the facility to minimize safety concerns).

For both private and City-maintained facilities where fencing is used, fences must be at least 6 feet high. The six-foot height may not be required in situations where fences are not needed to prevent climbing (e.g., on steep slopes where they are needed to prevent slipping). For City-maintained facilities, a minimum of one vehicular locking access gate must be provided. It must be 12 feet wide, consisting of two swinging sections each six feet wide. At least one pedestrian gate must be provided, with a minimum four-foot width.

Fencing materials must be complementary to the site design. If chain link fencing is proposed for a City-maintained facility, it must be specified in accordance with the [City of Portland Standard Construction Specifications](#).

Submittal Requirements

See [Section 2.4](#) for submittal requirements for the design specific approach.

2.3.4.13. Sand Filters

Facility Description

Sand filters, like planters, are structural landscaped reservoirs used to collect, filter, and infiltrate stormwater, allowing pollutants to settle and filter out as the water percolates through the sand and gravel. They can be constructed above, at, or below grade. Depending on site conditions, sand filters can be designed to completely infiltrate all the stormwater they receive, as partial infiltration facilities where only a portion of the flow is infiltrated and overflow is directed to an approved discharge location, or as a fully lined facility. If designed as a subsurface sand filter, the sand filter may be considered a UIC under DEQ regulations (see [Section 1.3.3](#) for more information on UIC requirements).

Sand filters must be designed and submitted under the Performance Approach (see [Section 2.2.3](#)) to meet the site-specific stormwater requirements outlined in [Chapter 1](#).

Design Requirements

Soil suitability: Existing infiltration rates will determine if the facility can be designed to achieve infiltration, partial infiltration, or allow the stormwater to be conveyed through the facility. See [Section 2.3.6](#) for infiltration testing procedures. If the tested infiltration rate is less than 2 inches per hour, the sand filter should be designed as a partial infiltration facility, with an overflow to an approved discharge location.

Setbacks: Infiltration sand filters typically have 5-foot setbacks from property lines and 10-foot setbacks from building foundations. No setbacks are required for lined sand filters where the height above finished grade is 30 inches or less. Lined sand filters can be used next to foundation walls, adjacent to property lines, or on slopes. See Table 2-1 for more information on setbacks.

Sizing: Sand filters must be designed to meet the stormwater management requirements as specified in [Chapter 1](#). Sand filters must be designed to pond water for less than 4 hours after each storm event.

Dimensions and slopes: The minimum lined sand filter width is 18 inches, and the minimum infiltration planter width is 30 inches. The minimum sand filter depth is 18 inches. Sand filters are relatively flat facilities that must not slope more than 0.5 percent in any direction. Where the facility is at or above grade, the storage depth must be at least 12 inches between the top of the filter medium and the base of the

overflow, unless a larger-than-required planter square-footage is used. For subgrade facilities, the filter medium must be 30 inches deep, with 8 inches of gravel above and below for conveyance. A minimum of 2 inches of freeboard (vertical distance between the overflow inlet elevation and overtopping elevation) must be provided.

Walls: Walls must be concrete unless otherwise approved. For facilities that require an impervious bottom, a single-pour concrete solution is preferred. Chemically treated wood that can leach out toxic chemicals and contaminate stormwater may not be used.

Waterproofing (if required): If walls are monolithically poured, no additional liner/waterproofing is required. Check state structural requirements for foundations.

Piping: Piping must be cast iron, ABS SCH40, or PVC SCH40. Three-inch pipe is required for facilities draining up to 1,500 square feet of impervious area; otherwise, a 4-inch pipe minimum is required. Piping installation must follow current Uniform Plumbing Code. For streets, 6-inch or 8-inch ASTM 3034 SDR 35 PVC pipe and perforated pipe are required. Refer to the City's [Sewer and Drainage Facilities Design Manual](#) for more information.

Where a collector manifold with perforated lateral branch lines is used, lateral branch line spacing must not exceed 10 feet. The underdrain laterals must be placed with positive gravity drainage to the collector manifold. The collector manifold must have a minimum 1 percent grade toward the discharge joint. All laterals and collector manifolds must have cleanouts installed, accessible from the surface without removing or disturbing filter media.

Drainage Layer: Drain rock is required below the sand. For infiltration facilities where drain rock is specified to retain stormwater prior to infiltration, the specification is 1½-to ¾-inch washed drain rock. Where drain rock is specified primarily for detention and conveyance, the specification is ¾-inch washed drain rock. All lined facilities must use ¾-inch washed drain rock. Drain rock and must be separated by geotextile fabric or use a 2- to 3-inch layer of ¾- to ¼-inch washed, crushed rock.

Vegetation: Plantings are recommended in sand filters. Plants enhance infiltration, prevent erosion, and compete with weeds.

For public sand filters, the following additional criteria apply:

- The sand filter must consist of an inlet structure, sand bed, underdrain piping, and liner.

- The inlet structure must spread the flow of incoming water uniformly across the surface of the filter medium during all anticipated flow conditions. This flow must be spread in a manner that prevents roiling or otherwise disturbing the filter medium.
- The sand bed length-to-width ratio must be 2:1 or greater.
- The sand bed filter medium must be certified by a testing laboratory as meeting the gradation specifications in Figure 2-22. The sand bed filter mediums must consist of clean medium to fine sand with no organic material or other deleterious materials.

Figure 2-22. Filter Bed Gradation Specification

Sieve Size	Percent Passing
3/8"	100
#4	95-100
#8	80-100
#16	45-85
#30	15-60
#50	3-15
#100	< 4

Submittal Requirements

See [Section 2.4](#) for submittal requirements for the design specific approach.

Construction Considerations

Special attention should be paid to structural waterproofing if the facility is constructed adjacent to building structures. The location of the infiltration sand filter must not be subject to compaction prior to, during, and after the construction of the facility.

2.3.4.14. Soakage Trenches

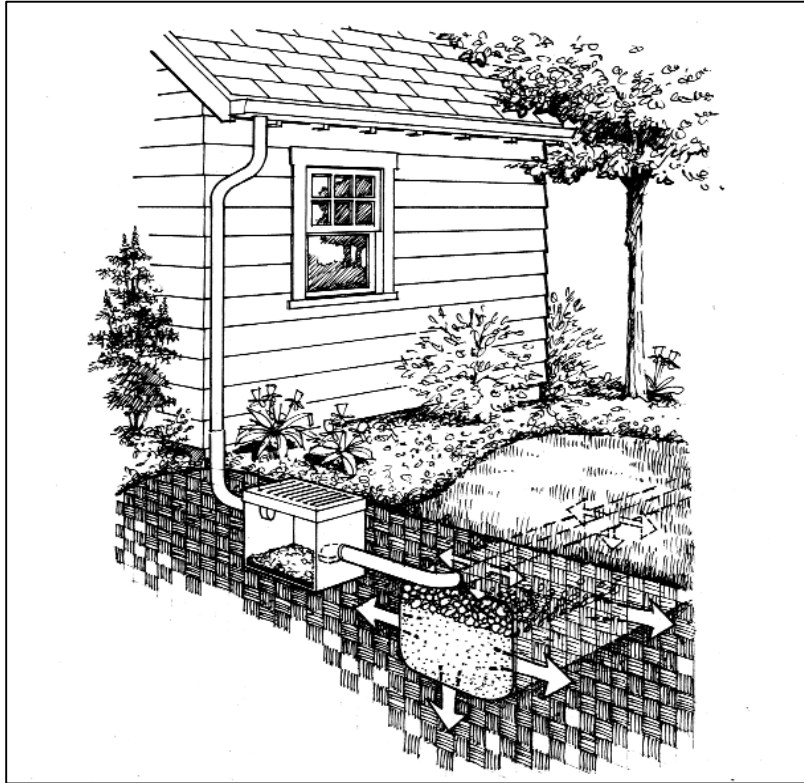

Soakage trenches allow water to soak into the ground through underground trenches.

Facility Description

A soakage or infiltration trench is a shallow trench in permeable soil that is backfilled with washed drain rock. The trench surface may be covered with grass, stone, sand, or plantings. Private soakage trenches can be used to provide stormwater discharge by collecting and recharging stormwater runoff into the ground. The use of soakage trenches is highly dependent on the soil type and height of the groundwater table. Soakage trenches are not allowed in the right-of-way.

See the City's [Source Control Manual](#) for site activities or areas affected by source control requirements. Additional requirements may be applicable within [Wellhead Protection Areas](#).

Underground Injection Control (UIC)

Soakage trenches are “Class V Injection Wells” under the federal UIC regulations. These facilities must be registered with Oregon DEQ and classified as exempt, authorized by rule, or authorized by permit. Since the UIC Program states that these types of trenches can have a direct impact on groundwater, pollution reduction is required before discharging stormwater into them (unless they are used exclusively for residential roof runoff from two units or less or pedestrian-only plaza areas on private property).

For more information about UIC requirements, refer to [Section 1.3.3](#) or visit [DEQ's website](#).

Design Requirements

Soil suitability: Soil conditions are critical to the success of soakage trenches. Submission of infiltration test results is required and must be approved by BES. Infiltration test results must be recorded on the Simplified Approach Form where the Simplified Approach is applicable and otherwise in the Stormwater Management Report (see [Section 2.4](#)). Supporting geotechnical analysis is required for slopes of 20 percent or greater, or when requested.

A 2-inch/hour infiltration rate is required at the facility base.

All trenches must be constructed in native soil and must not be subject to vehicular traffic or construction work that will compact the soil, thus reducing permeability.

There must be a 5-foot separation distance from the bottom of the trench to any impervious layer or water table. Soakage trenches are not allowed in areas of shallow groundwater where the separation distance from the bottom of the trench to seasonally high groundwater is less than 5 feet.

Setbacks: Soakage trenches typically have 5-foot setbacks from property lines and 10-foot setbacks from building foundations, unless an appeal is approved by BDS. One hundred-foot setbacks are typical for slopes 20 percent or greater. See Table 2-1 for more information on setbacks. Trenches may not be constructed under current or future impervious surfaces.

Sizing: Sizing requirements vary by design approach. Pore space of the fill material should be 30 percent, with vertical infiltration area only. The trench must infiltrate the entire design storm without overflow. The maximum impervious area to be served by a soakage trench is 10,000 square feet.

Simplified Approach: Soakage trenches are designed with minimum infiltration rate of 2.00 inches per hour. The minimum length is 20', width is 2.5' and depth is 1.5'

Performance Approach: Design by professional per hierarchy requirements. Minimum drawdown time for a soakage trench is 10 hours.

Drainage Layer: A minimum of 12 or 18 inches of open graded washed ¾- to 2½-inch round or crushed rock separated from soil by one layer of geotextile fabric.

Geotextile fabric: Use appropriate filter fabric between the medium and native soils and covering the perforated pipe to prevent clogging.

Piping: The solid conveyance piping from a building or other source must be installed at a ¼-inch per linear foot slope prior to connection with perforated pipe.

A minimum 12-inch cover is required from the top of all piping to the finished grade. All piping within 10 feet of a building must be 3-inch sch. 40 ABS, sch. 40 PVC, or cast iron for rain drain piping serving 1,500 square feet or less of impervious area. For an area greater than 1,500 square feet, 4-inch pipe must be used.

The pipe within the trench must be either PVC D2729 or HDPE leach field pipe. Perforated pipe must be laid on top of gravel bed and covered with geotextile fabric.

Traps: Lynch-style catch basins are required for soakage trenches to meet the "Discharge to UIC" criteria in Section 1.3.3. Silt traps are optional for all installations and are strongly encouraged because they will lengthen the life of the facility. If installed, the silt trap must be between the dwelling and the trench, a minimum of 5 feet from the dwelling.

Gravel Pits

Gravel pits must be sized and permitted the same as soakage trenches but can only treat up to 250 square feet.

Manufactured Chamber Technologies

Corrugated plastic stormwater chambers are generally made of high-density polypropylene or polyethylene. They are arched systems that can be rated for H-10 or H-20 loading, depending on the manufacturer, amount of cover, and type of cover.

Chamber systems function similarly to the standard soakage trench, but are often used in areas with limited infiltration because of high groundwater or shallow (<5 feet) infiltration barriers such as dense silt and clay layers. They provide temporary storage of stormwater prior to infiltration and may be able to be used with soils that infiltrate less than 2 inches per hour, with BES approval. Chambers are UICs and require DEQ registration (unless they are used exclusively for residential roof runoff from two units or less or pedestrian-only plaza areas on private property).



Sizing: Where the Simplified Approach can be used, the chambers must be designed to at least the same requirements as trenches. Pore space of the fill material is assumed to be 0.30. Figure 2-23 shows manufactured chamber technology dimensions.

Figure 2-23. Manufactured Chamber Technology Dimensions

Impervious Area Ratio	Design Infiltration Rate (in/hr)	Length (in)	Width (in)	Height (in)
1 per 600sf IA*	2.00	~90	34	16 + 6" base rock

Based on standard chamber sizing

Setbacks: Manufactured chambers are typically 10 feet on center from all foundations and 5 feet from property lines. See Table 2-1 for more information on setbacks.

Fill: Six inches of open graded washed drain rock is required below chamber. Additional depth or length will be required for infiltration rates less than the infiltration rates specified.

Typical Details: See [Section 2.3.5](#) for typical details for soakage trenches designed under the Simplified Approach (SW-100's).

Submittal Requirements

See [Section 2.4](#) for submittal requirements for the design specific approach.

Construction Considerations

Soakage trench areas must be clearly marked before site work begins to avoid soil disturbance during construction. No vehicular construction traffic, except that specifically used to construct the facility, should be allowed within 10 feet of soakage trench areas.

The bottom of the soakage trench must be level, or clay check dams may be used to prevent water from collecting near the downstream end. Soakage trench and perforated pipe must be installed level and parallel to the contour of the finish grade.

2.3.4.15. Drywells



Drywells allow stormwater to soak into the ground through underground rings (above shows drywell ring being lowered into ground).

Facility Description

The typical drywell is a precast concrete ring in 5-foot-tall sections perforated to allow for infiltration. These facilities are vertical in nature and can range from 5 to 20 feet in depth. Drywells require a minimum of 5 feet of vertical separation between the bottom of the drywell and seasonal high groundwater (see [Section 2.3.6](#) for determining depth to groundwater). Drywells should not be located in dense silt or clay soils, and may only be located in areas with soils suitable for infiltration.

See the City's [Source Control Manual](#) for site activities or areas affected by source control requirements. Additional requirements may be applicable within [Wellhead Protection Areas](#).

Underground Injection Control (UIC)

Drywells are “Class V Injection Wells” under the federal UIC regulations. These facilities must be registered with Oregon DEQ and classified as exempt, authorized by rule, or authorized by permit. Since the UIC Program states that drywells can have a direct impact on groundwater, pollution reduction is required before discharging stormwater into them (unless they are used exclusively for residential roof runoff from two units or less or pedestrian-only plaza areas on private property).

For more information about UIC requirements, refer to [Section 1.3.3](#) or visit [DEQ's website](#).

Design Requirements

Soil suitability: Soil conditions are critical to the success of drywells. An infiltration test or bore-log feasibility test must be performed and the results submitted to BES for approval. The Simplified Approach Form (See [Section 2.4.3](#)) must be completed and signed by the applicant, where applicable; otherwise, the sizing and infiltration must be accounted for in the Stormwater Management Report using the Performance Approach and the Rational Method. Drywells should be used only if the soils infiltrate at least 2 inches per hour or with documented approval from BES. Installation of drywells in fill material is not permitted. All drywells must be installed in native soils. Supporting geotechnical evidence is required for all slopes of 20 percent or greater or when requested.

Setbacks: The drywell is typically 10 feet on center from all foundations and 5 feet from property lines. The top of the perforated drywell sections must be located downgrade from foundations and at a lower elevation than local basements. See Table 2-1 for more information on setbacks. Drywells sized using volume as part of the calculation must keep the maximum water surface elevation for the required design storm at least 1-foot below the lowest finished floor elevation (including that of neighboring properties).

If drywell is approved for within building setbacks or under building foundations via plumbing code appeal, it will require design to accommodate 100-year storm event in lieu of an escape route. In addition, system capacity must be protected with sedimentation control devices and the O&M must specify requirements that will protect long-term capacity and escape routes. For infiltration systems proposed underlying structures, a geotechnical report will be required which addresses the

effect of the system on the performance of the foundation as well as the effect of foundations loads on the infiltration system.

Drywells sized using the Performance Approach that have more than the typical 12-inches of rock around the ring must measure setbacks from the edge of the rock gallery or get approval from the geotechnical and structural engineers to place the drywell closer to foundations.

Sizing: Varies by approach.

Simplified Approach: The chart provided in Figure 2-24 must be used to appropriately size the drywell(s) based on the amount of impervious area that each drywell is designed to manage. Dark gray boxes indicate acceptable.

Figure 2-24. Drywell Sizing Chart

Impervious Area (sf)	28" Diameter				48" Diameter			
	5'	10'	15'	20'	5'	10'	15'	20'
1000	Dark Gray	Dark Gray	Dark Gray	Dark Gray	Dark Gray	Dark Gray	Dark Gray	Dark Gray
2000	White	Dark Gray	Dark Gray	Dark Gray	Dark Gray	Dark Gray	Dark Gray	Dark Gray
3000	White	White	Dark Gray	Dark Gray	Dark Gray	Dark Gray	Dark Gray	Dark Gray
4000	White	White	White	Dark Gray	White	Dark Gray	Dark Gray	Dark Gray
5000	White	White	White	White	White	Dark Gray	Dark Gray	Dark Gray
6000	White	White	White	White	White	Dark Gray	Dark Gray	Dark Gray
7000	White	White	White	White	White	White	Dark Gray	Dark Gray
8000	White	White	White	White	White	White	Dark Gray	Dark Gray
9000	White	White	White	White	White	White	Dark Gray	Dark Gray
10000	White	White	White	White	White	White	White	Dark Gray
11000	White	White	White	White	White	White	White	Dark Gray
12000	White	White	White	White	White	White	White	Dark Gray

Performance Approach Allowable Calculations: Drywells can be sized on a flow-rate basis or a single storm hydrograph-based analysis. Flow-rate based facility design must use the Rational Method and may only count the bottom area when determining infiltration capacity. Hydrograph-based designs should use a time-based model and may account for storage within the drywell and in the associated rock gallery.

In all cases infiltration rates can be calculated using the bottom area of the drywell and rock gallery. Infiltration rates through side-walls may be accounted for if a time-

based model is used for the sizing and a geotechnical engineer determines it is appropriate for the local soils. Fine grained soils can be smeared during construction, this prevents infiltration and may be difficult to control for. Upper layers of soil may have different infiltration rates than deeper soils. These factors must be considered when making the decision to include side-wall infiltration rates.

Traps: Lynch-style catch basins are required for drywells to meet the “Discharge to UIC” criteria in [Section 1.3.3](#). Silt traps are optional for all installations and are strongly encouraged because they will lengthen the life of the facility. If installed, the silt trap must be between the dwelling and the drywell, a minimum of 5 feet from the dwelling.

Manufactured Plastic Drywells

Manufactured plastic “mini-drywells” are made of hard plastic (foam polyolefin) and are very versatile. The excavations for these facilities can be hand-dug, and the drywells can be placed by hand rather than using equipment (as with typical concrete drywells).

Dimensions: Two-foot diameter, two-foot depth, plus one-foot gravel lens below and on the sides.

Sizing: One (1) unit for every 500 square feet of impervious area, with BES approval.

Setbacks: From center:

One unit: Five feet to property line, eight feet to any foundation, and 20 feet to existing cesspools.

Multiple units or in-line units: Five feet to property line, ten feet to any foundation, and 20 feet to existing cesspools.

Typical Details: See [Section 2.3.5](#) for typical details for drywells designed under the Simplified Approach (SW-100’s).

Submittal Requirements

See [Section 2.4](#) for submittal requirements for the design specific approach.

Construction Considerations

If smooth excavation tools are used, scratch the sides and bottom of the excavation hole with a sharp pointed instrument and remove the loose material from the bottom of the excavation. This will break-up any smearing that could potentially limit infiltration rates.

2.3.4.16. Sumps

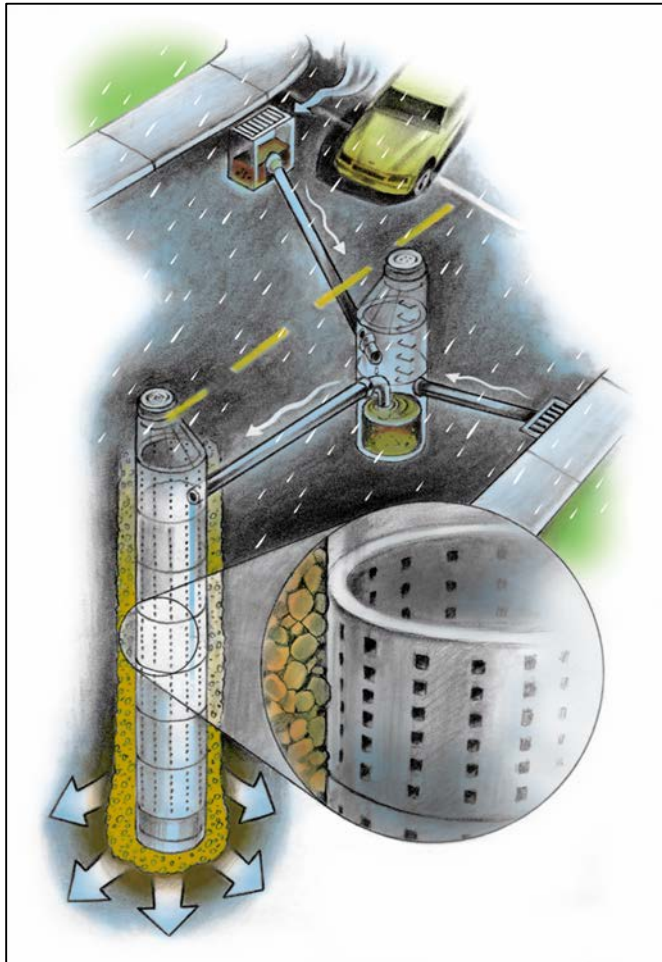

A sump allows stormwater to infiltrate into the ground through underground rings.

Facility Description

Sumps are a disposal method for managing stormwater runoff. Public infiltration sump systems can be used to provide drainage from public streets by collecting stormwater and infiltrating it into the ground. The use of sumps is dependent on soil type and depth to seasonal groundwater. Sumps are different from drywells in that they are designed using precast 4-foot-diameter concrete rings with perforations, typically 30 feet deep and located in the public right-of-way. Like drywells, sumps require a minimum 5 feet of vertical separation between the bottom of the sump and seasonal high groundwater.

Underground Injection Control

Sumps are "Class V Injection Wells" under the federal UIC Program. These facilities must be registered with DEQ and authorized by rule or authorized by permit. In the case of City sumps, BES administers the rule authorization process with DEQ.

For more information about UIC requirements, refer to [Section 1.3.3](#) or visit [DEQ's website](#).

A sump system is the total of all sump components at a single location (e.g., an intersection) and consists of inlets, piping, a sedimentation manhole, and a sump. If one sump lacks adequate capacity to handle the design flow, a second sump may be placed in series with the first to provide additional capacity.

Sedimentation manholes with oil traps receive runoff from inlets before stormwater enters the sumps. The sedimentation manholes settle out most of the large particulate material that can clog sump drainage holes, which decreases maintenance needs and increases long-term effectiveness. Detailed drawings of a standard sump and standard sedimentation manhole can be found in the [City of Portland Standard Drawings and Details P-160 thru P-162](#).

When constructed according to the standard design procedures, the sump system achieves pollution reduction benefits. The sedimentation manhole reduces pollution through removal of sediment, oils, and grease. Other types of facilities (e.g., swales or planters) may be used to provide pollution reduction instead of sedimentation manholes and may be required in certain circumstances (see [Section 1.3.3](#) for criteria about discharging to UICs).

Sump systems are excluded from use within the following specific areas and land use types within the City:

- Major City traffic streets (including district collectors) in combined sewer areas, or neighborhood collectors in commercially zoned areas (Refer to Transportation Element, Comprehensive Plan, Office of Transportation, 2000).
- Additional requirements may be applicable within designated [Wellhead Protection Areas](#) (see [Section 1.1.3](#)).

Design Requirements

Soil suitability: Soil conditions are critical to the success of sump systems. The use of sumps will not be approved without supporting geotechnical evidence and a documented sump test to demonstrate they will work in the particular area of interest. The geotechnical evidence must include test sump data to provide information about local underground soil conditions and the potential infiltration capacity of the surrounding soil.

Sizing: Public sump systems must be designed to handle twice the flow from the calculated design storm.

- Hydraulic calculations for public sumps must be performed using the Rational Method. Information on the use and application of the Rational Method is found in the City's [Sewer and Drainage Facilities Design Manual](#).
- Sumps must be designed for a 10-year design storm, with a safety factor of 2.
- The time of concentration for sump design must be 5 minutes.

Dimensions:

- A maximum of two sumps must be used in series, unless approved by BES.
- The minimum distance between sumps must be 25 feet.
- The desired distance between the sump and sedimentation manhole is 25 feet. This figure is a guideline and depends on site conditions.
- Sumps must not be located in areas with a constant or seasonally high groundwater table or shallow bedrock. The bottom of the sump must be at least 5 feet above the seasonal high water table and at least 3 feet above bedrock.
- Sumps must not be located within 200 feet from the tops of slopes more than 10 feet high and steeper than 2h:1v.
- The sump depth must be 30 feet, unless otherwise approved by BES.
- The sedimentation manhole depth must be 10 feet.

Piping: The diameter of pipe between the sump and sedimentation manhole must be 12 inches. Note: The pipe leaving the sedimentation manhole is fitted with a 90-degree short-radius elbow. See [City of Portland Standard Drawings and Details P-160 thru P-162](#).

See the [City of Portland Sewer and Drainage Facilities Design Manual](#) for acceptable pipe material types between the sump and sedimentation manhole.

Typical Details: See [City of Portland Standard Drawings and Details P-160 thru P-162](#) typical details.

Public Sump System Testing

Before being accepted by the City, all public sumps must be tested after construction to ensure they meet or exceed the design capacity. Standard sump notes on the plan set are required to document design rates and sump testing. See Figure 2-26 for plan set standard language.

The City may require the engineer or qualified design professional to supply a sump testing table (see Figure 2-25) to determine if the sump is performing as designed or if an additional sump may be required.

Submittal Requirements

See [Section 2.4](#) for submittal requirements for the design specific approach.

Figure 2-25. Sump Data Table

Sump Number	Sheet No.	DEQ ID	UIC Registration ID	Min. Percolation Rate Required (GPM)	Hydrant Location for Sump Testing	Testing Flow Rate (GPM)	R/W Drainage Area (sf)

Figure 2-26. Standard Sump Notes for Plan Set

1. Design flows reflect a factor of safety of 2.
2. All sumps must be tested by the contractor as directed and approved by the BES field Inspector.
3. Sump testing must take place after sump construction is complete and before the construction of the sedimentation manhole. Should a sump test fail to verify adequate capacity, an additional sump, constructed in series with the first sump (a maximum of two sumps per system) must be required. Should a test of two sumps in series fail to verify adequate capacity, an alternative public stormwater destination must be required, as approved by BES.
4. Notify BES field inspector and BES Construction Manager at least 48 hours before beginning sump testing. A BES representative must be present during all sump capacity tests.
5. BES will contact the Portland Water Bureau or applicable water district to arrange for sump test water supply and obtain the necessary permits. Upon receipt of hydrant permit, the Contractor can contact BES Materials Testing Laboratory (MTL) and make arrangements to lease sump testing equipment. Contractor can also lease similar testing equipment from any vendor with BES approval.
6. MTL Sump testing equipment is subject to leasing conditions and fees. Note that sump capacity tester is available on a first come – first served basis. The tester and pipe trailers may be rented per day for a maximum of two days per written application. Contact MTL, located at 1405 N River, at (503) 823-2340. Insurance on the MTL leased equipment is required.
7. Provide water flow from fire hydrants to sump being tested using an 8-inch nominal diameter pipe. Deliver clean potable water to sumps. Introduction of sediment is not acceptable and may result in failure of sump capacity test and reconstruction of sump.
8. The test may be completed using flow from one fire hydrant. However, a second fire hydrant may be necessary to complete the sump test.
9. Fill sump with water at an initial rate of 300 gallons per minute (gpm), and record water elevation below sump rim after five minutes. Maintain initial flow rate and continue taking recordings of the water elevation at five-minute intervals until the water surface reaches a constant elevation. Then increase flow rate by 300 gpm, and record the water elevation at the new flow rate as described in the initial process. Continue the sump test by increasing the flow rate at increments of 300 gpm until the sump has reached its maximum capacity.
10. Upon completion of each sump test, compare tested sump capacity flow rate to the minimum flow rate noted in the Plans. Notify Owner immediately if tested flow rate is less than the minimum flow rate listed.
11. Contractor must sign the sump testing results and submit to the BES field inspector.
12. The closest fire hydrant for sump tested is located at the intersections as shown in the Sump Data Table.

2.3.4.17. Manufactured Stormwater Treatment Technologies

Facility Description

The City of Portland maintains a list of approved manufactured stormwater treatment technologies for use under the Performance Approach in meeting pollution reduction requirements when discharging to stormwater-only systems. Use of a vegetated stormwater facility must be demonstrated as infeasible in order for BES to approval use of a manufactured stormwater treatment technology. The list of approved manufactured stormwater treatment technologies is posted on the [BES website](#) and includes unit sizing to meet the City's pollution reduction requirements and any required conditions of use.

Manufactured stormwater treatment technologies on BES's approved list must be designed and constructed in accordance with the manufacturer's specifications. Each site plan must undergo manufacturer review before the City of Portland can approve the design for site installation. A letter that certifies that the project has been designed to manufacturer's specifications must be submitted to BES prior to the appropriate design milestone. For public improvements, including Public Works Permits, the letter must be submitted to BES prior to 60% plan review. For installation on private property, the letter must be submitted prior to building permit plan approval.

Manufactured stormwater treatment technologies not on the approved list can be submitted using the Performance Approach for site-specific review and approval. Site specific approval under the Performance Approach is site-specific and does not imply any wider approval or precedent.

Submittal Requirements

In addition to design calculations provided in the Stormwater Management Report (see [Section 2.4.5](#) for Performance Approach Requirements), the following must be submitted with each project proposing use of a manufactured stormwater treatment technology:

- Flow-rate calculations to demonstrate that the MSTT will perform within the approved sizing standards.
- Identification of high flow bypass.
- Facility dimensions and setbacks from property lines and structures.
- Profile view of facility, including typical cross-sections with dimensions.

- All stormwater piping associated with the facility, including pipe materials, sizes, and slopes.
- High-flow or overflow bypass.
- Any necessary documentation to demonstrate compliance with the specific Conditions of Approval for that device.

Construction Considerations

Manufacturers may require use of specific installers and/or techniques. Any manufactured stormwater treatment technology must be installed as per manufacturers' specifications.

2.3.4.18. Rainwater Harvesting

Facility Description

Stormwater can be collected and reused for non-potable water uses within a house or building, or for landscape irrigation purposes. Uses can include reusing water in toilets (in multi-unit dwellings, a separate cistern is needed for each residence) and at hose bibs (a shared cistern can be used for landscape irrigation). All toilets and hose bibs must have permanent signage that notifies users of non-potable water. Any such system must obtain plumbing approval from BDS.

The Portland Water Bureau's Water Quality Inspections group also requires system containment backflow protection in the form of a reduced pressure (RP) type of backflow assembly. System containment RPs must be located on private property at the property line, immediately adjacent to the point of water service connection.

Rainwater harvesting can provide the following stormwater management benefits:

Flow control: In many areas of the City where onsite infiltration is not feasible and the only means of stormwater destination is offsite flow to a combination sewer system, rainwater harvesting can provide volume-reduction benefits. Depending on the size of the water storage facility and the rate of use, a percentage of the annual runoff volume can be reused. Where it is not feasible for rainwater harvesting to meet a development site's full stormwater management obligation, it can be used to manage a portion of the flow and lessen the overall stormwater management requirement.

Design Considerations

Figure 2-27 represents an analysis of a 5,000-square-foot project site with 100 percent impervious surface. The analysis used 8.5 months of 5-minute rainfall intensity data from the Fernwood rain gage in Portland and shows the relationship between water storage volume and average daily water use rate for average annual runoff capture goals of 30, 50, and 70 percent.

Figure 2-27. Rainwater Harvesting Average Annual Stormwater Runoff Capture Rates (5,000 square feet impervious surface)

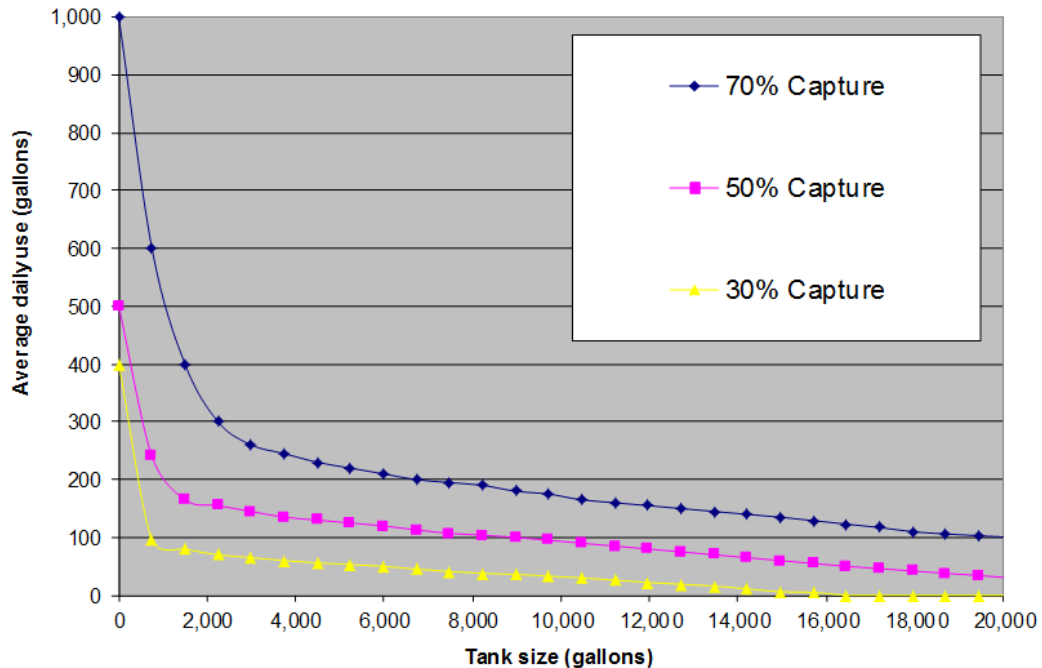

For example, if the stormwater management goal is 50 percent reduction of the annual release volume, the pink line shows that the average daily use would need to be approximately 160 gallons per day if a 2,000-gallon tank were used. A larger tank would need a smaller average daily use rate to achieve the same stormwater management goal of 50 percent annual volume reduction.

Submittal Requirements

See [Section 2.4](#) for submittal requirements for the design specific approach. The following information must also be included:

- Pollution reduction facility and efficiency details.
- Hydraulic calculations demonstrating compliance with stormwater management requirements (pollution and flow control).
- Overflow connection to approved stormwater disposal location, per [Section 1.3](#).
- Description of how the facility meets pollution reduction and flow control requirements.

All Plumbing Code requirements must be met and approved through BDS.

2.3.4.19. Structural Detention Facilities

Facility Description

Structural detention facilities such as tanks, vaults, and oversized pipes provide storage of stormwater as part of a flow control system. As with any structure, they must be designed not only for their function as runoff flow control facilities, but also to withstand an environment of periodic inundation, potentially corrosive chemical or electrochemical soil conditions, and heavy ground and surface loadings. They must also be accessible for maintenance. Facilities in this section must be designed using acceptable hydrologic modeling techniques (see [Section 2.2.3 Performance Approach](#)) to meet applicable flow control requirements. Additional facilities will be required to meet applicable pollution reduction requirements. Tanks and vaults can be used in conjunction with other detention storage facilities, such as ponds, to provide initial or supplemental storage.

Tanks and vaults typically do not have a built-in design feature for containing sediment, as do multi-cell ponds. Therefore, when tanks or vaults are used for detention storage, either a sedimentation manhole or surface sediment containment pond must be placed upstream of the tank or vault, or the tank/vault must be oversized to allow for the temporary accumulation of sediment. Maintenance is required to periodically remove sediment.

Design Requirements – detention tank, vault, and oversized pipe design

Access: All areas of a tank or vault must be within 50 feet of a minimum 36-inch-diameter access entry cover. All access openings must have round, solid locking lids.

Publicly owned detention tanks, vaults, and pipes are permitted within public rights-of-way. If developments are served with publicly operated and maintained tanks and vaults that are not located within the right-of-way, the tanks/vaults must be located in separate open space tracts with public sewer easements that are dedicated to the City of Portland. All privately owned and maintained facilities must be located to allow easy maintenance and access.

All tanks and vaults must be designed as lined systems.

Sizing: Minimum size for a public detention pipe must be 36 inches. If the collection system piping is designed also to provide storage, the resulting maximum water surface elevation must maintain a minimum 1-foot of freeboard in any catch basin below the catch basin grate. Pipe capacity must be verified using an accepted

methodology approved by the City (see City of Portland's [Sewer and Drainage Design Manual](#)). The minimum internal height of a vault or tank must be 3 feet, and the minimum width must be 3 feet. The maximum depth of the vault or tank invert is 20 feet.

Where the tank or vault is designed to provide sediment containment, a minimum of ½ foot of dead storage must be provided, and the tank or vault must be laid flat.

Materials and Structural Stability: For public facilities, pipe materials and joints must conform to the City of Portland [Sewer and Drainage Facilities Design Manual](#). For private facilities, the pipe material must conform to the Unified Plumbing Code.

All tanks, vaults, and pipes must meet structural requirements for overburden support and traffic loadings, if appropriate. H-20 live loads must be accommodated for tanks and vaults under roadways and parking areas. End caps must be designed for structural stability at maximum hydrostatic loading conditions.

Detention vaults must be constructed of structural reinforced concrete (3000 psi, ASTM 405). All construction joints must be provided with water stops.

In soils where groundwater may induce flotation and buoyancy, measures must be taken to counteract these forces. Ballasting with concrete or earth backfill, providing concrete anchors, or other counteractive measures must be required. Calculations must be required to demonstrate stability.

Tanks and vaults must be placed on stable, consolidated native soil with suitable bedding. Tanks and vaults must not be allowed in fill slopes, unless a geotechnical analysis is performed for stability and construction practices.

Flow Control Structures for Detention Systems: To restrict flow rates, a flow control structure must be used. This section presents the methods and equations for the design of flow-restricting control structures, for use with structural detention facilities. It includes details and equations for the design of orifices and equations for rectangular sharp crested weirs and v-notch weirs.

Note: Because of minimum orifice size requirements (2 inches for public facilities, 1 inch for private facilities), detention facilities that rely on orifice structures to control flows for small projects (under 15,000 square feet of impervious development footprint area) are not allowed.

Design Requirements – control structure design

Weir and orifice structures must be enclosed in a catch basin, manhole, or vault and must be accessible for maintenance.

The control structure must be designed to pass the 100-year storm event as overflow, without causing flooding of the contributing drainage area.

Orifices: Orifices may be constructed on a “tee” riser section or on a baffle.

The minimum allowable diameter for an orifice used to control flows in a public facility is 2 inches. Private facilities may use a 1-inch-diameter orifice if additional clogging prevention measures are implemented. The orifice diameter must always be greater than the thickness of the orifice plate.

Multiple orifices may be necessary to meet the 2- through 25-year design storm performance requirements for a detention system. However, extremely low flow rates may result in the need for small orifices (< 1 inch for private facilities, < 2 inches for public) that are prone to clogging. In these cases, retention facilities that do not rely on orifice structures must be used to the maximum extent practicable to meet flow control requirements (see [Section 1.3.4](#) or [Section 1.3.5](#)). Large projects may also result in high flow rates that necessitate excessively large orifice sizes that are impractical to construct. In such cases, several orifices may be located at the same elevation to reduce the size of each individual orifice.

Orifices must be protected within a manhole structure or by a minimum 18-inch-thick layer of 1½ - 3-inch evenly graded, washed rock. Orifice holes must be externally protected by stainless steel or galvanized wire screen (hardware cloth) with a mesh of ¾ inch or less. Chicken wire must not be used for this application.

Orifice diameter must be greater than or equal to the thickness of the orifice plate.

Orifices less than 3 inches must not be made of concrete. A thin material (e.g., stainless steel, HDPE, or PVC) must be used to make the orifice plate; the plate must be attached to the concrete or structure.

Orifice Sizing Equation:

$$Q = C A \sqrt{2gh}$$

where:

Q = Orifice discharge rate, cfs

C = Coefficient of discharge, feet (suggested value = 0.60 for plate orifices)

A = Area of orifice, square feet

h = hydraulic head, feet

g = 32.2 ft/sec²

The diameter of plate orifices is typically calculated from the given flow. The orifice equation is often useful when expressed as an equivalent orifice diameter in inches.

$$d = \sqrt{\frac{36.88 Q}{\sqrt{h}}}$$

where:

Q = flow, cfs

d = orifice diameter, inches

h = hydraulic head, feet

Rectangular Notched Sharp Crested Weir:

$$Q = C (L - 0.2H) * H^{1.5}$$

where:

Q= Weir discharge, cfs

C = 3.27 + 0.40×H/P, feet

P = Height of weir bottom above downstream water surface, feet

H = Height from weir bottom to crest, feet

L = Length of weir, feet*

* For weirs notched out of circular risers, length is the portion of the riser circumference not to exceed 50 percent of the circumference.

V-Notched Sharp Crested Weir:

$$Q = C_d \left(\tan \frac{\theta}{2} \right) H^{\frac{5}{2}}$$

where:

Q = Weir discharge, cfs

C_d = Contraction coefficient, feet (suggested value = 2.5 for 90 degree weir)

θ = Internal angle of notch, degrees

H = Height from weir bottom to crest, feet

Submittal Requirements

See [Section 2.4](#) for submittal requirements for the design specific approach. Additional information may be required on the drawings during permit review, depending on individual site conditions.

2.3.4.20. Drainageways and Drainage Reserves



Drainageways are landscape channels or depressions which continually or periodically convey water; this drainageway only has visible water in the winter during larger rainfall events.

Drainageways are constructed or natural channels or depressions that may collect and convey water at any time. A drainageway and its reserve area function together to manage flow rate, volume, and water quality.

A drainage reserve is a 30-foot wide buffer placed over a drainageway, centered on the middle of the channel. Drainage reserves are applied to drainageways to protect flow conveyance and receiving waters and to minimize impacts to properties downstream and upstream. Drainage reserves act as a no-build area, not an easement. In making a determination to place a drainage reserve over a drainageway and its buffer area, BES will evaluate the factors listed in [Section 1.3.4](#) and [Section 2.1.2](#). BES staff may allow modifications to a drainage reserve if the drainageway poses landslide, flooding, or other public health and safety concern. In those instances, drainageways may be modified by BES to protect public health and safety, in compliance Portland City Code with Title 24 and 33 regulations.

Proposed encroachments into the drainageway or drainage reserve must follow BES' requirements and standards and will require BES approval. Encroachments include, but are not limited to, culverts, outfalls, structures/buildings, paved areas, or decks and deck footings. Such proposals will be reviewed to ensure that the flow rate, timing, and pattern of the drainage continues be adequately conveyed through the site. See the design criteria in [Section 2.3.4.21](#) for Drainage Reserve Encroachments and [Section 2.3.4.22](#) for Channel Encroachments.

Proposed impacts to drainageways on property will be reviewed and inspected for protection and encroachment during the building permit process. All plan sets must clearly demark the drainageway, drainage reserve, proposed impacts, and appropriate protection measures (fencing, etc.). Any applicable maintenance practices, such as erosion control measures, must also be noted on plan sets. BDS staff will verify that erosion control protection and constructed encroachments are placed or built as shown on the site plan and will consult with BES staff on any concerns regarding adequacy of the applicant's efforts. Violations or failure to comply with drainage reserve protection requirements will be referred to BES staff for investigation and enforcement. Drainage reserve submittal requirements are found in [Section 2.4.7](#).

Additional Requirements

Requirements for protecting drainageways in the public right-of-way and for public improvements to drainageways are addressed the during the City's review of the design of the public improvements, which may include a Public Works Permit. Design requirements for public improvements of surface conveyance are found in the [Sewer and Drainage Facilities Design Manual](#).

A drainageway providing fish passage will need to follow the requirements of the Oregon Department of Fish and Wildlife (ODFW) and potentially other state and federal agencies.

Delineation of Drainageways and Drainage Reserves. Drainageways must be protected to ensure that the current flow rate, timing, and pattern of the drainage continues to be conveyed adequately through the site. The City places drainage reserves on drainageways based on the conveyance requirements provided in Section 1.3.4 (Stormwater System Requirements) based on the determination of a drainageway as identified by the factors listed in Section 2.1.2 (under the drainageway discussion of Site Planning). A drainage reserves is established and measured based on the delineation of the drainageway.

- For lots that are smaller than 10,000 square feet, the drainageway and the drainage reserve must be surveyed and delineated.
- For lots that are greater than 10,000 square feet, a survey is required to delineate drainageways within the disturbance area. If a drainageway is not within the disturbance area, drainage reserves will be placed but not delineated and the estimated location will be noted on the Operations and Maintenance site plan.

Placement of Drainage Reserves

BES will apply drainage reserves during the development review process. A drainage reserve is typically 30 feet in width, extending 15 feet from the centerline of the identified channel on each side, with the following exceptions:

- The drainage reserve's dimensions and shape will only encompass those areas of the drainageway that are not adequately protected by environmental protection zoning or land-use requirements; or
- The drainage reserve may be wider than 30 feet if needed to protect the channel, including, but not limited to, an outer boundary measuring a minimum of 15 feet from top of the channel's bank.

An applicant may request a smaller reserve area or width if the applicant can demonstrate that a smaller area will provide sufficient flow conveyance and water quality protection. BES will review and determine whether a smaller reserve sufficiently meets the drainage reserve goals.

Encroachments

BES will evaluate proposals to encroach into a drainage reserve based on the encroachment feature's proximity to the drainageway channel. Structures in drainage reserves can cause flow diversion, flow capacity reduction, bank stabilization issues, and impede fish and wildlife passage. Encroachments include,

but are not limited to, culverts, outfalls, structures/buildings, paved areas, or decks and deck footings. Encroachments into the reserve can cause floodplain impingements for high-flow conditions, erosion and water quality impairment and can result in the cumulative loss of floodplain space. Encroachments can also pose a risk to the encroaching structure. For ease of review, BES has separated the review of encroachment into two types (see Figure 2-28 for cross section identifying encroachment areas):

1. Drainage Reserve Encroachment – An encroachment that will be located within the outside 5-foot edge of a drainage reserve. See [Section 2.3.4.21](#) for the design criteria for Drainage Reserve Encroachments.
2. Channel Encroachment – An encroachment that will be located between the channel centerline and the outside 5-foot edge of a drainage reserve. If an applicant proposes removing more than 10 percent of the entire reserve area, the impacts will be reviewed under the Channel Encroachment review criteria. See [Section 2.3.4.22](#) for the design criteria for Channel Encroachments.

Figure 2-28. Drainage Reserve Cross Section

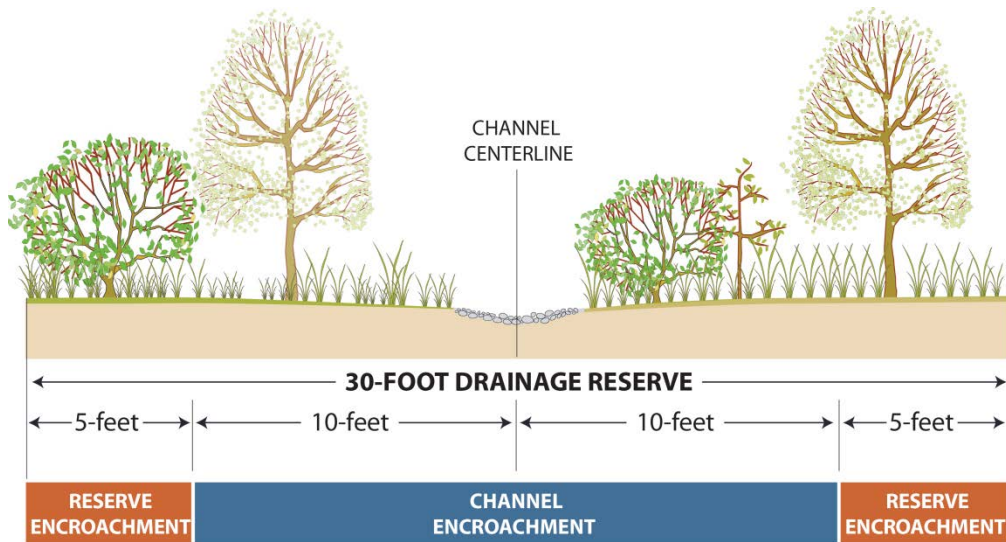

City of Portland Environmental Services ES 1604

Submittal Requirements

See [Section 2.4.7](#) for submittal requirements for drainage reserves.

2.3.4.21. Drainage Reserve Encroachments

Any structure within 5 feet of a drainage reserve boundary is considered a drainage reserve encroachment. Encroachments include, but are not limited to, structures/buildings, paved areas, or decks and deck footings. Encroachments into the drainage reserve require ongoing maintenance by the property owner as per the recorded operations and maintenance plan.

Vegetation: Native plants are required in disturbance areas in drainage reserves. For plant recommendations, see the [Portland Plant List](#). Choose plants appropriate for the native plant community type as described in the Portland Plant List. Vegetation must be planted in quantities as per Figure 2-29 and must reach 90 percent vegetation cover within one year. See Portland City Code Title 11 for tree requirements relating to development situations and Title 33 for vegetation requirements related to applicable environmental zoning. For public natural areas with approved master plans or management plans, vegetation requirements may vary.

Figure 2-29. Vegetation Density for Drainage Reserve Encroachments

Number of Plants	Vegetation Type	Per square feet	Size	Spacing density (on center)
115	Herbaceous plants	100	#1 container	12"
OR				
100	Herbaceous plants	100	4" pots	12"
4	Small shrubs	100	#1 container	Per plan
OR				
240	Herbaceous	100	Plugs	6"

Channel Crossing

Appropriate road-crossing methods are allowed as a drainage encroachment and are dictated by site-specific drainageway flow characteristics. Drainageway impacts must be avoided wherever practicable, including:

- Proposed street improvements should not impede or restrict flows within the drainageway.

- Proposed street improvements should minimally impact slope, width, depth and bed composition of the drainageway.
- Proposed street improvements should not impede fish passage in a drainageway that has been identified by the Oregon Department of Fish and Wildlife as fish bearing or historically fish bearing.
- Exposed soil must be replanted with native plants from the Portland Plant List.
- Before a water crossing structure or culvert may be placed within a drainageway that provides or could provide fish passage or other wildlife benefits requirements, Oregon Department of Fish and Wildlife (ODFW) consultation and approval will be required.

Additional Design Requirements

Requirements for protecting drainageways in the public right-of-way and for public improvements to drainageways are addressed during the City’s review of the design of public improvements, including improvements requiring Public Works Permits. Design requirements for public improvements are found in the [Sewer and Drainage Facilities Design Manual](#).

If a drainageway provides fish passage or other wildlife benefits, Oregon Department of Fish and Wildlife (ODFW) consultation and approval will be required.

[Drainage Reserve Encroachment Standards](#)

For encroachments within the outside 5-foot edge of the drainage reserve, the proposal may be approved if the applicant has clearly demonstrated that ALL of the following standards maybe met:

- The encroachment will be minimized to the maximum extent practicable.
- The encroachment will occur in the most environmentally sensitive manner, considering seasonality, slope, soil, geologic, and erosion control issues to limit disturbance impact to flow capacity, connectivity, and channel stability.
- All mitigation for disturbances within the drainage reserve limits will be located on the project site. Proposed mitigation will equal or exceed any loss in conveyance volume, flow rate control, and vegetation density within the drainage reserve limits. See Figure 2-30 for an example of a drainage reserve encroachment with mitigation plantings.

- All structures, mitigation plantings, and drainageway improvements must be maintained in accordance with the submitted O&M plan. Vegetation coverage within the drainage reserve area must achieve 90% coverage within one year following construction.
- Proper temporary and permanent erosion control and exclusionary fencing measures, including but not limited to, those required by the [Erosion and Sediment Control Manual](#), will be employed to ensure adequate protection of the drainageway during construction and during the establishment of vegetation within the drainage reserve limits.

Figure 2-30. Example of Drainage Reserve Encroachment.

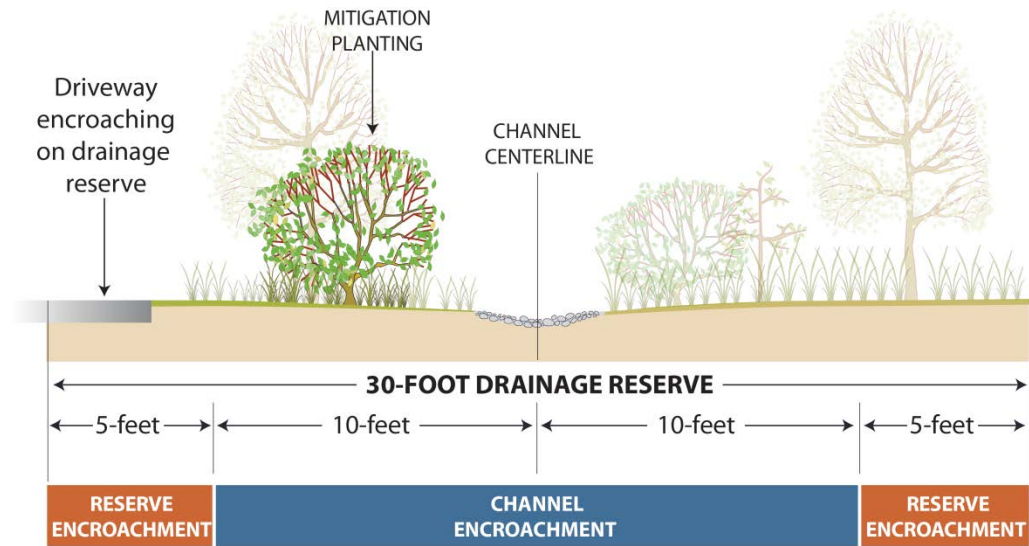

City of Portland Environmental Services ES 1604

Encroachments include, but are not limited to, culverts, outfalls, structures/buildings, paved areas, or decks and deck footings.

Submittal Requirements

See [Section 2.4.7](#) for submittal requirements for drainage reserve encroachments and for design approach specific requirements.

2.3.4.22. Channel Encroachments

An encroachment that will be located between the channel centerline and the outside 5-foot edge of the drainage reserve or a proposal that will remove more than 10 percent of the entire reserve area on the development-related side of the drainage channel will be reviewed under channel encroachment criteria. Any proposals to move or otherwise modify the channel itself will also be reviewed under the channel encroachment criteria. Encroachments include, but are not limited to, culverts, outfalls, structures/buildings, or decks and deck footings. Channel encroachment requirements are in addition to the drainage reserve encroachment requirements. Encroachments near or modifications to a channel require ongoing maintenance by the property owner per the recorded operations and maintenance plan. The channel encroachment proposal may be approved if the applicant clearly demonstrates that all requirements of the drainage reserve encroachment standards and ALL of the following will be met:

- The encroachment will not worsen any existing drainageway conditions, such as channel erosion, channel hardening, or water impoundment.
- The channel encroachment will be mitigated by modifying the channel to retain its original capacity or by enhancing storage and conveyance volumes.
- Flows must be conveyed around the encroachment area during construction.
- Flows resulting from the encroaching facility must leave the site in a location and manner that maximizes the watershed benefits of the drainageway. Flow rates and outlet locations may be altered to improve watershed function. Hydrologic and/or hydraulic modeling may be required, depending on site conditions and the extent of encroachment.
- Erosion control measures must be used during construction of the improved/modified drainageway to ensure protection and functionality of the existing stormwater conveyance system. Erosion control measures to protect the drainageway are independent of those required on the building permit.

Flow volumes and/or drainageway capacities will be determined by the City's review of a number of information sources, including but not limited to:

- Drainage basin hydrology and hydrologic records.
- Delineation of the drainage catchment, including any impacts of adjacent open and piped drainage systems on the drainage catchment of concern.

- Modeling information, including volume and velocity, using a continuous simulation model as approved by BES.
- Historical data, such as permit records or monitoring data.
- Topographic features, if any, including LIDAR or other mapping based methods depicting channel migration zones, high water marks or other demarcations of drainage capacity.
- Soil inundation measures.
- Photographs of past flooding limits.

Additional Design Requirements

Requirements for protecting drainageways in the public right-of-way and for public improvements to drainageways are found in the City's [Sewer and Drainage Facilities Manual](#) and the technical standards of the City of Portland Standard Construction Specifications.

If a drainageway provides fish passage or other wildlife benefits, Oregon Department of Fish and Wildlife (ODFW) consultation and approval will be required.

Channel Encroachment Exemptions: Single outfalls 4" or smaller from stormwater management facilities, regardless of location, are allowed to encroach outright if they meet the standards that govern outfalls in the City's environmental zoning code (Chapter 33.430). These standards address many environmental sensitivity issues and are being used as a guide for the approval of all small outfalls, both within and outside of environmental overlay zones that reach drainageways. Outfalls that meet environmental zone standards are exempt from channel encroachment review and submittal requirements. Approval requests for all other outfalls will be processed according to the review standards and submittal requirements detailed below.

Vegetation: Native plants are required in disturbance areas in drainage reserves. For plant recommendations, see the [Portland Plant List](#). Choose plants appropriate for to the native plant community type as described in the Portland Plant List. Vegetation must be planted in quantities as Figure 2-31 and must reach 90 percent vegetation cover within one year. See City Code Title 11 for tree requirements relating to development situations and Title 33 for vegetation requirements related to applicable environmental zoning. For public natural areas with approved master plans or management plans, vegetation requirements may vary.

Figure 2-31. Vegetation density for Channel Encroachments

Number of Plants	Vegetation Type	Per square feet	Size	Spacing density (on center)
2	Trees	100	6' min height or 1 ½" caliper	Per plan
10	Shrubs	100	#1 Container	1'
70	Herbaceous plants	100	4" pots	12"
OR				
240	Herbaceous plants	100	Plugs	6"

Submittal Requirements

See [Section 2.4.7](#) for submittal requirements for channel encroachments and for design approach specific requirements.

Construction Considerations

Temporary and permanent erosion control measures must meet the requirements in the City's Erosion and Sediment Control Manual. Additional erosion control measures (e.g., reinforced silt fence, bio-filter bags, or erosion blankets) may be required to ensure adequate protection of the drainageway during construction and during the establishment of vegetation within the drainage reserve.

During site construction, water must be safely conveyed around or through the drainageway. The channel must not be obstructed, with the exception of properly employed erosion control measures (such as bio-filter bags) when necessary. Seasonal limitations on development in or near the reserve may be placed if there are special site conditions such as those defined in City Code Title 10, or if such conditions are otherwise required by regulatory agencies including Oregon Dept. of Fish and Wildlife timing guidelines for in-water work.

Heavy machinery that produces excessive ground compaction may not be allowed within the drainage reserve during construction. Low ground-pressure vehicles (such as spider hoes or those approved under Environmental Zoning or Greenway Code allowances) may be allowed if the applicant can show adequate soil and vegetation protection during construction and restoration.

2.3.5 Typical Details

Typical details for stormwater management facilities have been developed to provide standard design specifications. Typical details for private stormwater facilities built under the Simplified Approach are found in the SW-100's. Typical details for private stormwater facilities built under the Presumptive or Performance Approach are found in the SW-200's. Typical details for public stormwater facilities in the public right-of-way are found in the SW-300's.

2.3.5 Private Simplified Stormwater Facility Typical Details

Table of Contents

- SW-100 - Ecoroof
- SW-101 - Habitat Ecoroof
- SW-110 - Pervious Pavement
- SW-120 - Downspout Extension
- SW-121 - Rain Garden
- SW-130 - Swale - Lined
- SW-131 - Swale - Unlined
- SW-140 - Planter - Lined
- SW-141 - Planter - Unlined
- SW-142 - Planter - Site Configurations
- SW-150 - Basin - Lined
- SW-151 - Basin - Unlined
- SW-160 - Filter Strip
- SW-170 - Soakage Trench
- SW-180 - Drywell
- SW-190 - Facility Overflow Configurations

- DRAWING NOT TO SCALE -

STORMWATER MANAGEMENT TYPICAL DETAILS

Simplified Facilities
Table of Contents

NUMBER

TOC
7-1-16



Bureau of Environmental Services



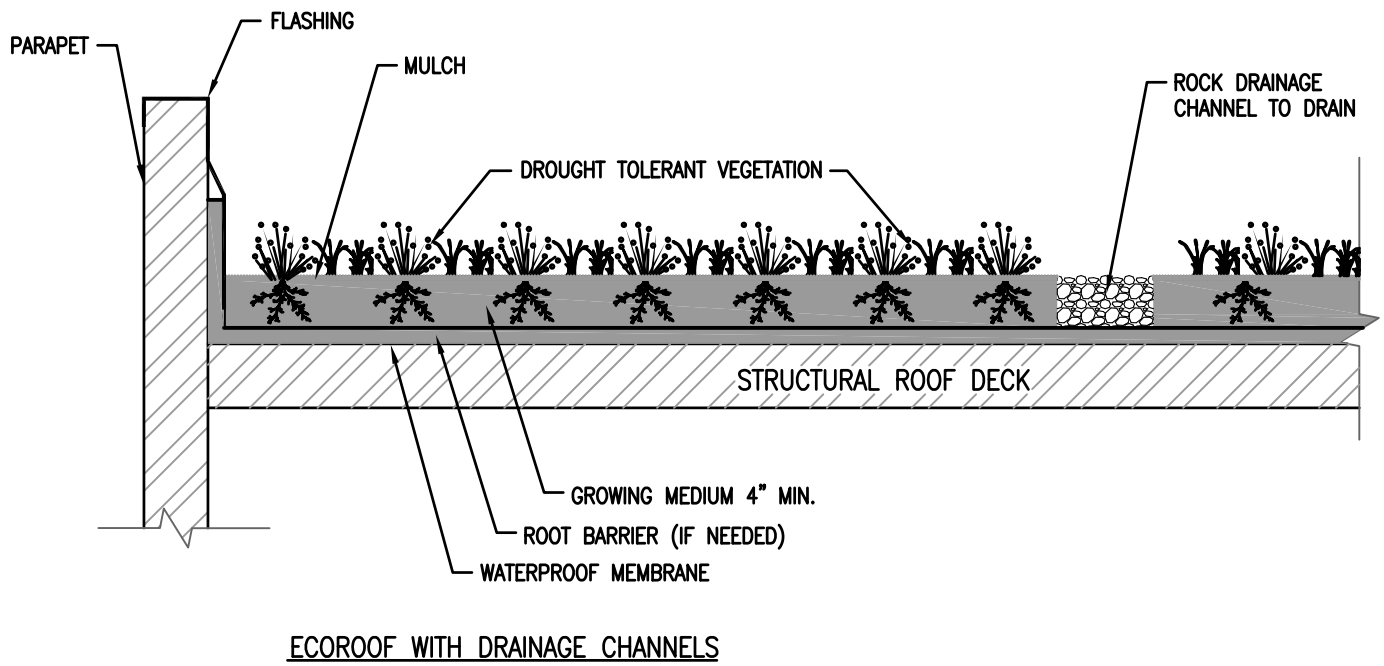
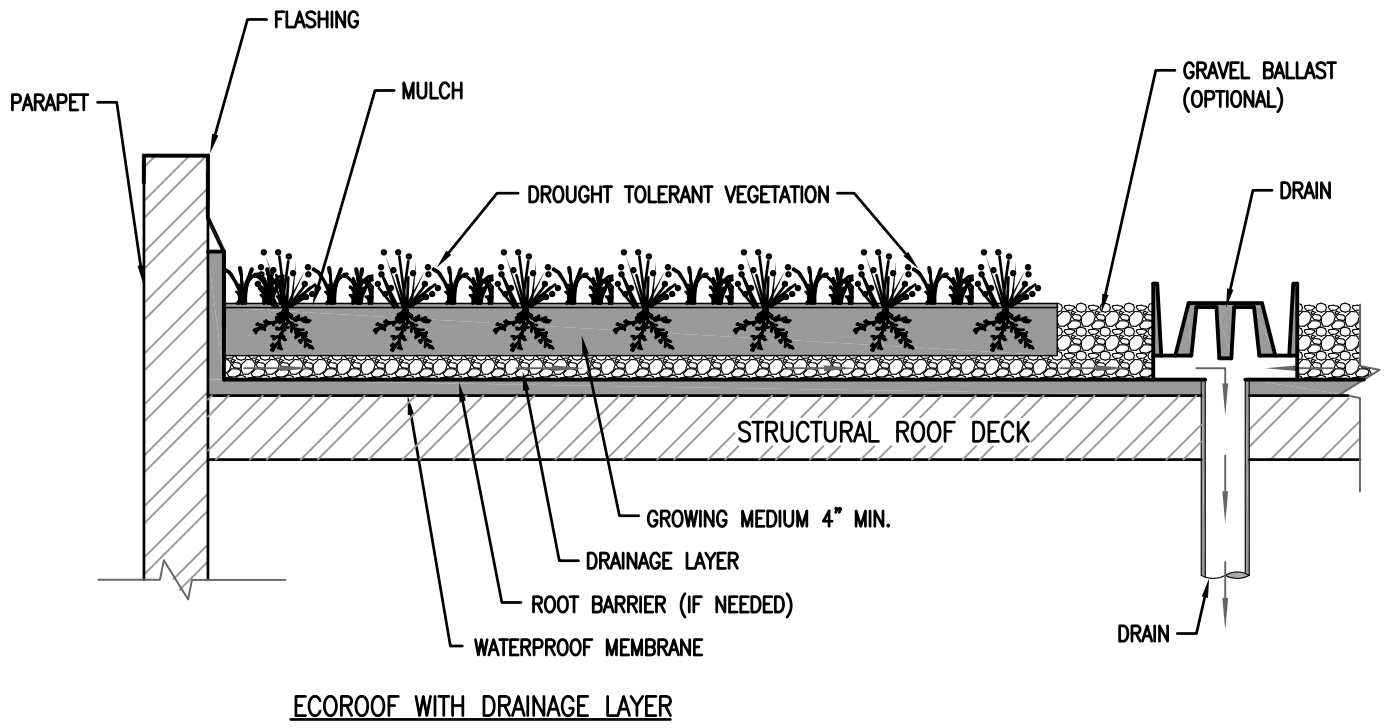

- DRAWING NOT TO SCALE -

STORMWATER MANAGEMENT TYPICAL DETAILS

- Simplified Design Approach -
Ecoroof



Bureau of Environmental Services



NUMBER

SW-100
7-1-16

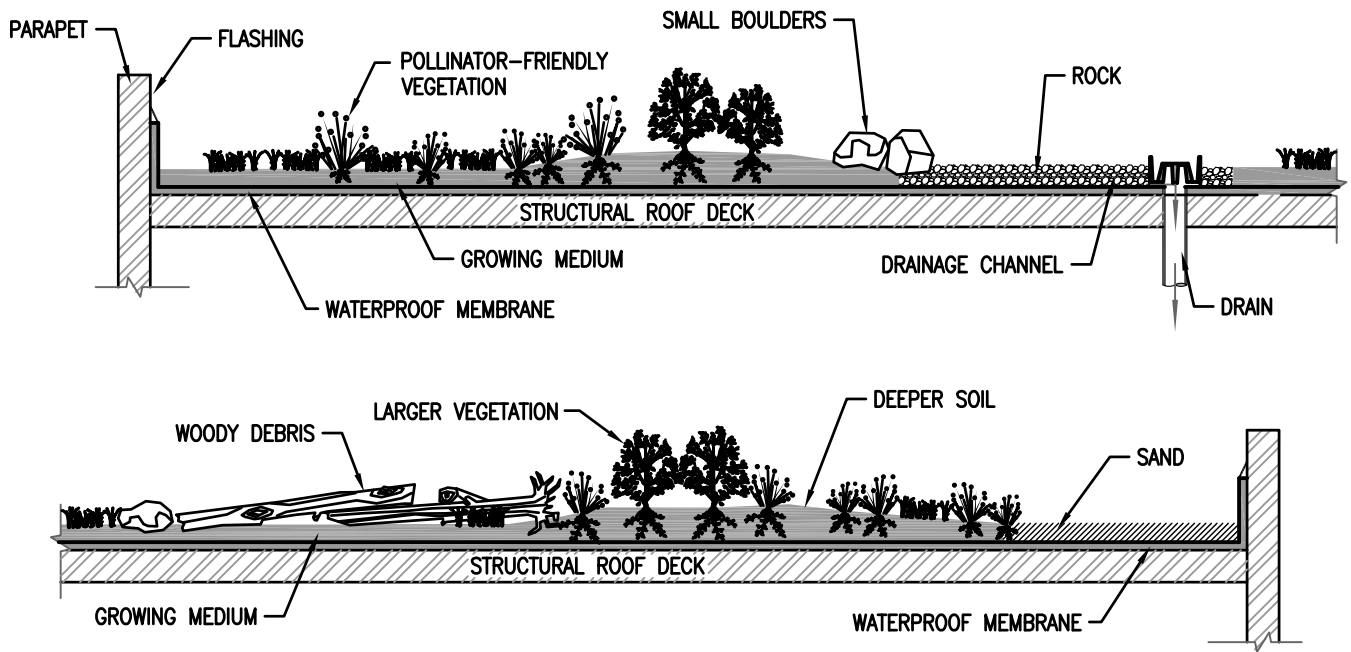

HABITAT ECOROOF EXAMPLE SECTIONS

NOTE: Building elements such as glass and lighting placed near ecoroofs have the potential to exacerbate bird-srike mortality. BES recommends designs comply with Portland's Resource Guide for Bird-Friendly Building Design: <http://www.portlandoregon.gov/bps/article/446308>

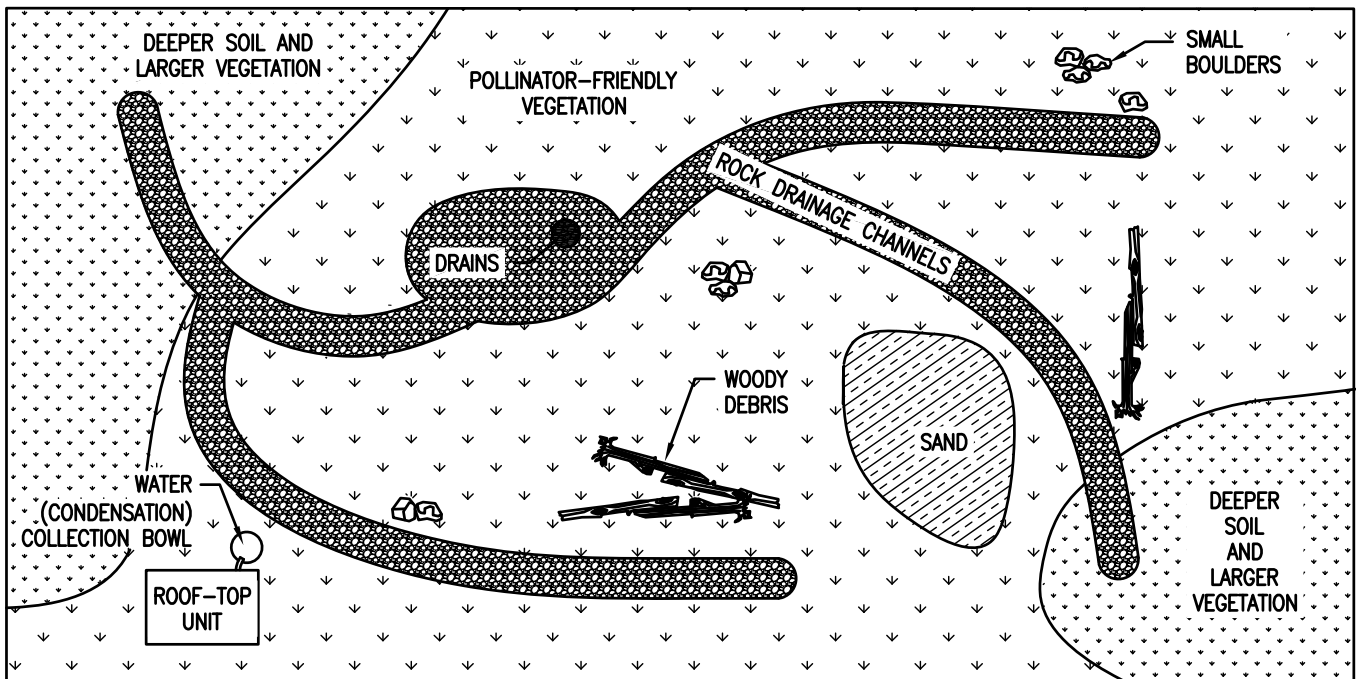

HABITAT ECOROOF WITH DRAINAGE CHANNELS - EXAMPLE PLAN

- DRAWING NOT TO SCALE -

STORMWATER MANAGEMENT TYPICAL DETAILS

- Simplified Design Approach -
Habitat Ecoroof

NUMBER

SW-101

7-1-16



Bureau of Environmental Services



	RESIDENTIAL DRIVEWAY OR PEDESTRIAN ONLY
CONCRETE	4"
ASPHALT	2 1/2"
PAVERS	2 3/8"
ENGINEERING REQ'D	NO
COMPACTION REQ'D	NO

EXHIBIT 2-8

DESIGN REQUIREMENTS FOR TOP LIFT DEPTH

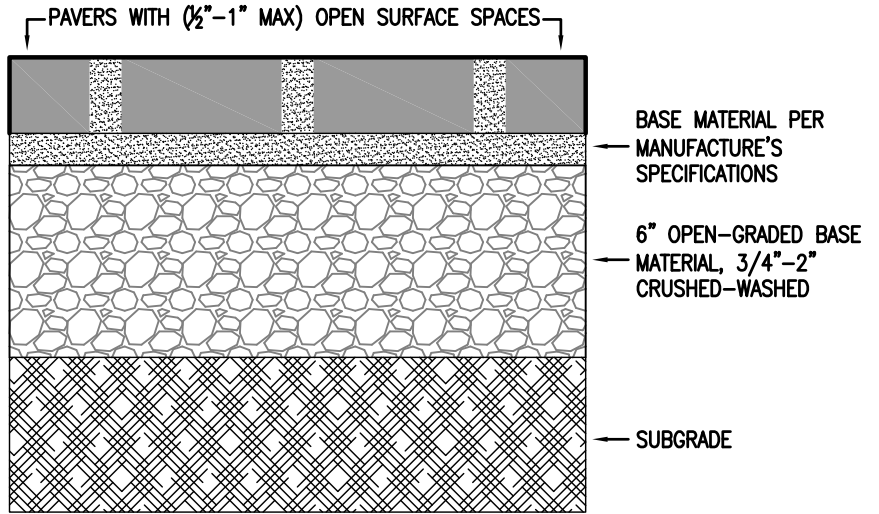

PERMEABLE CONCRETE BLOCK OR "PAVER" SYSTEMS

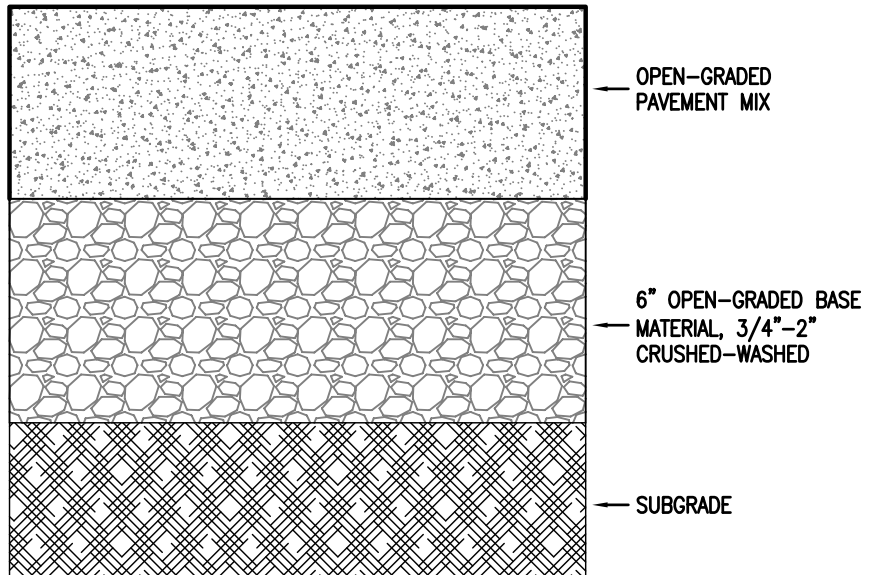

PERVIOUS (OPEN GRADED) CONCRETE AND ASPHALT SYSTEMS

- DRAWING NOT TO SCALE -

STORMWATER MANAGEMENT TYPICAL DETAILS

- Simplified Design Approach -
Pervious Pavement
Pedestrian and Residential Driveway Only



Bureau of Environmental Services



NUMBER
SW-110
7-1-16

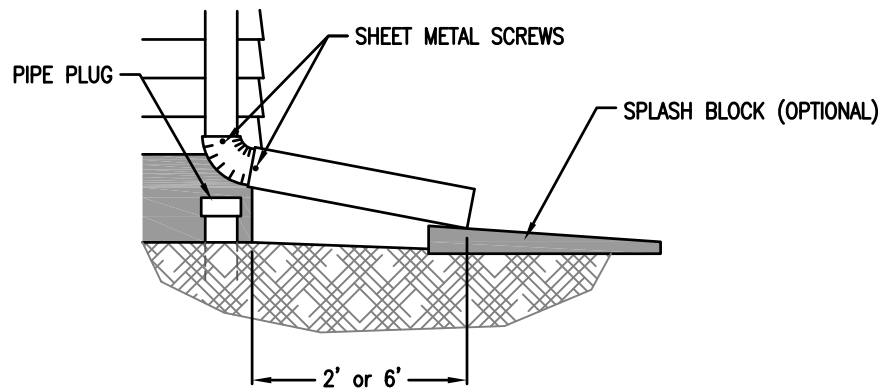

1. Site Suitability: Downspout extensions are suitable for sites that have well draining soils, >2" per hour, and have an overall slope of 10% or less.
2. Sizing: Area of discharge must be 10% of the contributing roof area. A maximum of 500 sf of roof area is allowed to drain to each downspout.
3. Downspouts must drain at least 6 feet from basement walls and at least 2 feet from crawl spaces and concrete slabs.
4. The end of the downspout must be at least 5 feet from the property line, and possibly more if the landscape slopes toward the neighbor's property.
5. Do not discharge onto driveways, hardscape or other impervious areas including public sidewalks and streets.
6. Using a splash block at the end of the extension is optional, but it will help prevent soil erosion.

- DRAWING NOT TO SCALE -

STORMWATER MANAGEMENT TYPICAL DETAILS

- Simplified Design Approach -
Downspout Extension



Bureau of Environmental Services



NUMBER

SW-120

7-1-16

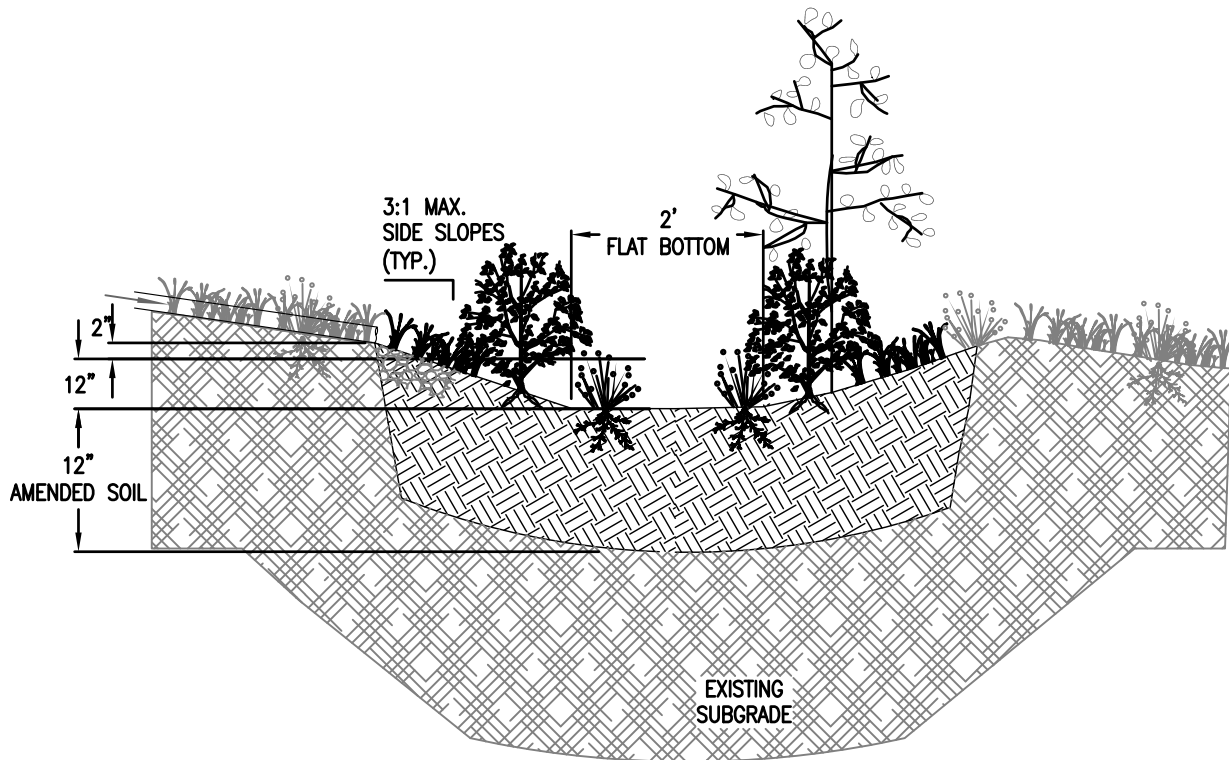

1. Provide protection from all vehicle traffic, equipment staging, and foot traffic in proposed infiltration areas prior to, during, and after construction.
2. Dimensions:
Ponding depth (from top of growing medium to overflow elevation): 12".
Flat bottom width: 2'x2' min.
Side slopes of swale: 3:1 maximum.
3. Setbacks:
A ten foot setback required from buried oil tanks or retaining walls over 36 inches high. The deepest point of a rain garden should be at least 10 ft from all structures. It is recommended to avoid installation over water service lines.
4. Overflow:
Each rain garden design needs to include an escape route that allows stormwater to drain to a safe disposal point in periods of heavy rainfall, away from building foundations and adjacent properties. Escape routes should be planted or rocked to assist with potential erosion issues.
5. Piping: must be composed of cast iron or Schedule 40 ABS per 2.3.4 and the Uniform Plumbing Code. Flexible downspout extensions are not approvable materials.
6. Growing Medium: Amend native soils with 3 inches of compost blended 12 inches into native soil.
7. Vegetation: Follow landscape plans otherwise refer to plant list in SWMM section 2.4.1. Minimum container size is #1. # of plantings per 100sf of facility area:
80 herbaceous plants OR 72 herbaceous plants and 4 shrubs.
Consider adding a tree if the rain garden is over 200 sf.
8. Splash Block: Splash blocks, rock, or flagstone must be utilized for erosion control and flow dispersal at the point of discharge.
9. Mulch: Rain gardens may be topped with 2" of compost
10. Inspections: Call BDS IVR Inspection Line, (503) 823-7000, request 487. 3 inspections required.

- DRAWING NOT TO SCALE -

STORMWATER MANAGEMENT TYPICAL DETAILS

- Simplified Design Approach -
Rain Garden



Bureau of Environmental Services



NUMBER

SW-121
7-1-16

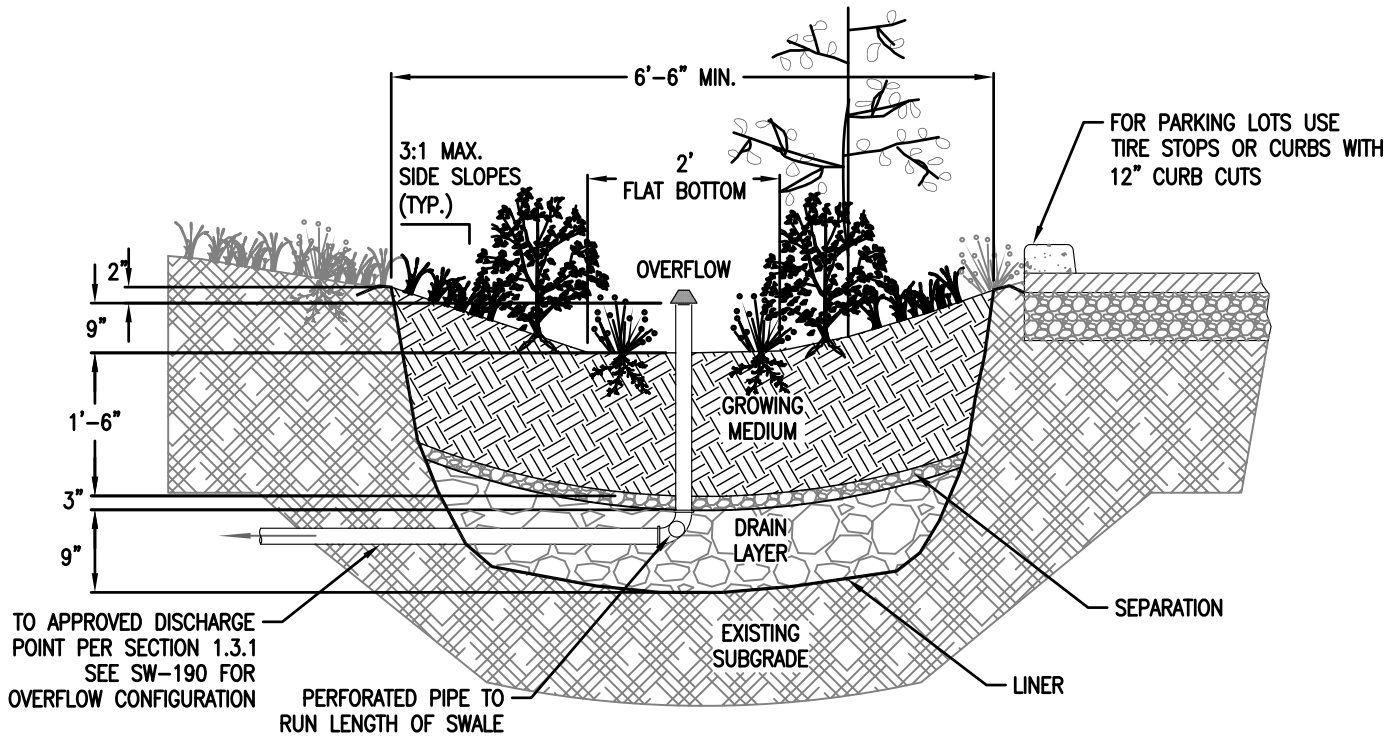

1. Dimensions:
Width of swale: 6'-6" minimum
Depth of swale (from top of growing medium to overflow elevation): 9".
Longitudinal slope of swale: 6.0% or less.
Flat bottom width: 2' recommended.
Side slopes of swale: 3:1 maximum.
2. Overflow: Swales must connect to approved discharge point according to SWMM Section 1.3.1 and detail SW-190.
Inlet elevation must allow for 2" of freeboard, minimum.
Protect from debris and sediment with strainer or grate.
3. Piping must be cast iron, ABS or PVC. 3" pipe required for facilities draining up to 1500 s.f., otherwise 4" minimum pipe. Uniform Plumbing Code also applies.
4. Drain Layer:
3/4" - 1 1/2" washed round rock. Depth: 9".
Separation between drain rock and growing medium:
Pea gravel lens, 2 to 3 inches deep.
5. Growing Medium:
18" minimum depth. Use sand/loam/compost 3-way mix, or approved mix that will support healthy plants.
24" minimum depth is required if the lined facility is also meeting BDS landscape requirements.
6. Vegetation: Follow landscape plans otherwise refer to plant list in SWMM section 2.4.1. Minimum container size is #1. # of plantings per 100sf of facility area:
Zone A (wet): 80 herbaceous plants OR 72 herbaceous plants and 4 small shrubs.
Zone B (moderate to dry): 7 large or small shrubs AND 70 groundcover plants.
The delineation between Zone A and B must be either at the outlet elevation or the check dam elevation, whichever is lowest.
If project area is over 200sf consider adding a tree.
7. Check Dams: Must be placed every 10' where slope exceeds 4% and be equal to the width of the planter.
8. Waterproof Liner: 30 mil EPDM, HDPE or approved equivalent.
9. Splash Block: Install 4-6" washed river rock or splash pad for erosion control at inlets and downspout.
10. Inspections: Call BDS IVR Inspection Line, (503) 823-7000, request 487. 3 inspections required.

- DRAWING NOT TO SCALE -

STORMWATER MANAGEMENT TYPICAL DETAILS

- Simplified Design Approach -
Swale - lined



Bureau of Environmental Services



NUMBER

SW-130

7-1-16

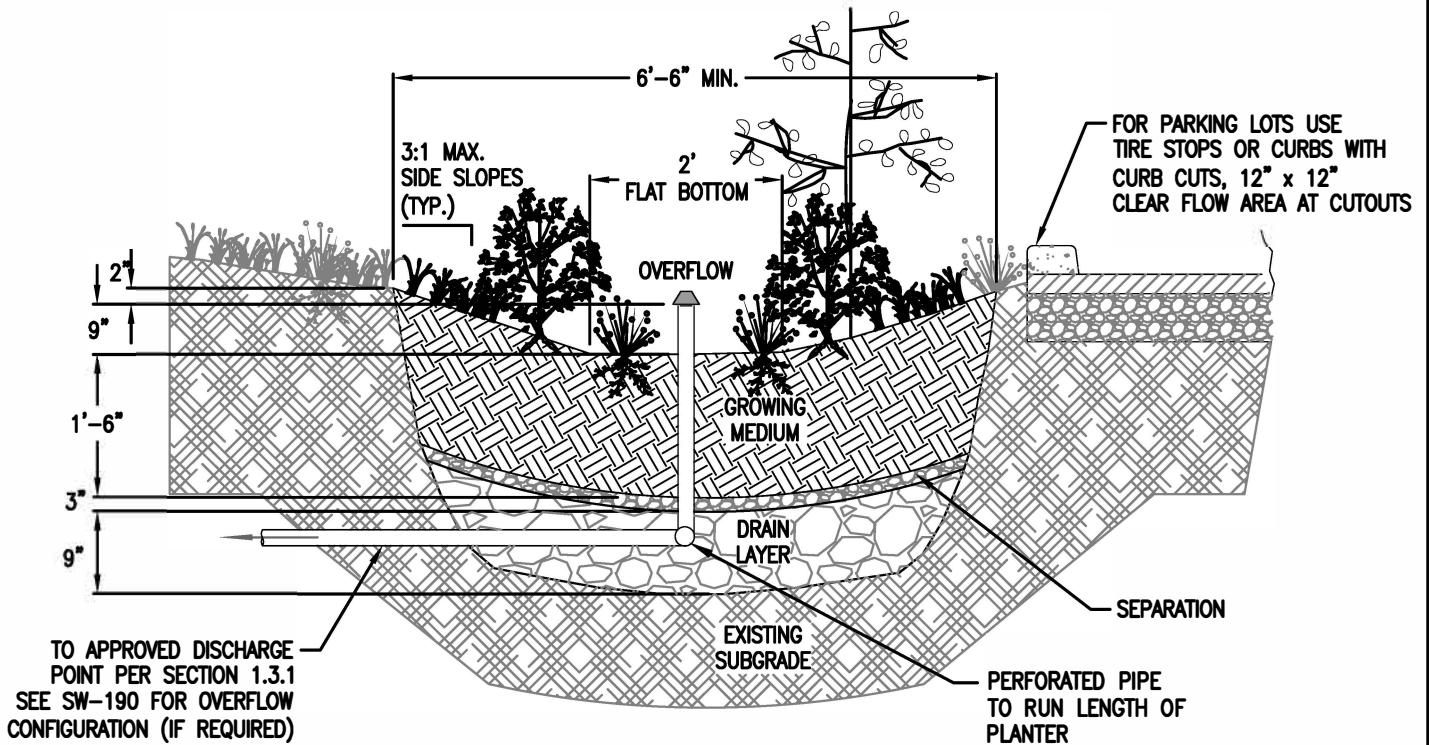

1. Provide protection from all vehicle traffic, equipment staging, and foot traffic in proposed infiltration areas prior to, during, and after construction.
2. Dimensions:
Width of swale: 6'-6" minimum
Depth of swale (from top of growing medium to overflow elevation): 9".
Longitudinal slope of swale: 6.0% or less.
Flat bottom width: 2' recommended.
Side slopes of swale: 3:1 maximum.
3. Setbacks:
Swale must be 10' away from foundation and 5' away from property lines.
4. Overflow:
Swales must connect to approved discharge point according to SWMM Section 1.3.1.
Inlet elevation must allow for 2' of freeboard, minimum.
Protect from debris and sediment with strainer or grate.
5. Piping must be cast iron, ABS or PVC. 3" pipe required for facilities draining up to 1500 s.f., otherwise 4" minimum pipe. Uniform Plumbing Code also applies.
6. Drain Layer:
3/4" - 1 1/2" washed rock. Depth: 12".
Separation between drain rock and growing medium:
Pea gravel lens, 2 to 3 inches deep.
7. Growing Medium:
18" minimum depth. Use sand/loam/compost 3-way mix, or approved mix that will support healthy plants.
8. Vegetation: Follow landscape plans otherwise refer to plant list in SWMM Section 2.4.1. Minimum container size is #1. # of plantings per 100sf of facility area:
Zone A (wet): 80 herbaceous plants OR 72 herbaceous plants and 4 small shrubs.
Zone B (moderate to dry): 7 large or small shrubs AND 70 groundcover plants.
The delineation between Zone A and B shall be either at the outlet elevation or the check dam elevation, whichever is lowest.
If project area is over 200sf consider adding a tree.
9. Check Dams: Shall be placed every 10' where slope exceeds 4% and be equal to the width of the planter.
10. Splash Block: Install 4-6" washed river rock or splash pad for erosion control at inlets and downspout.
11. Inspections: Call BDS MR Inspection Line, (503) 823-7000, request 487. 3 inspections required.

- DRAWING NOT TO SCALE -

STORMWATER MANAGEMENT TYPICAL DETAILS

- Simplified Design Approach -
Swale - unlined



Bureau of Environmental Services



NUMBER

SW-131
7-1-16

ADJACENT TO BUILDING

Design professional is responsible for verifying that grades will allow piped conveyance to facility.

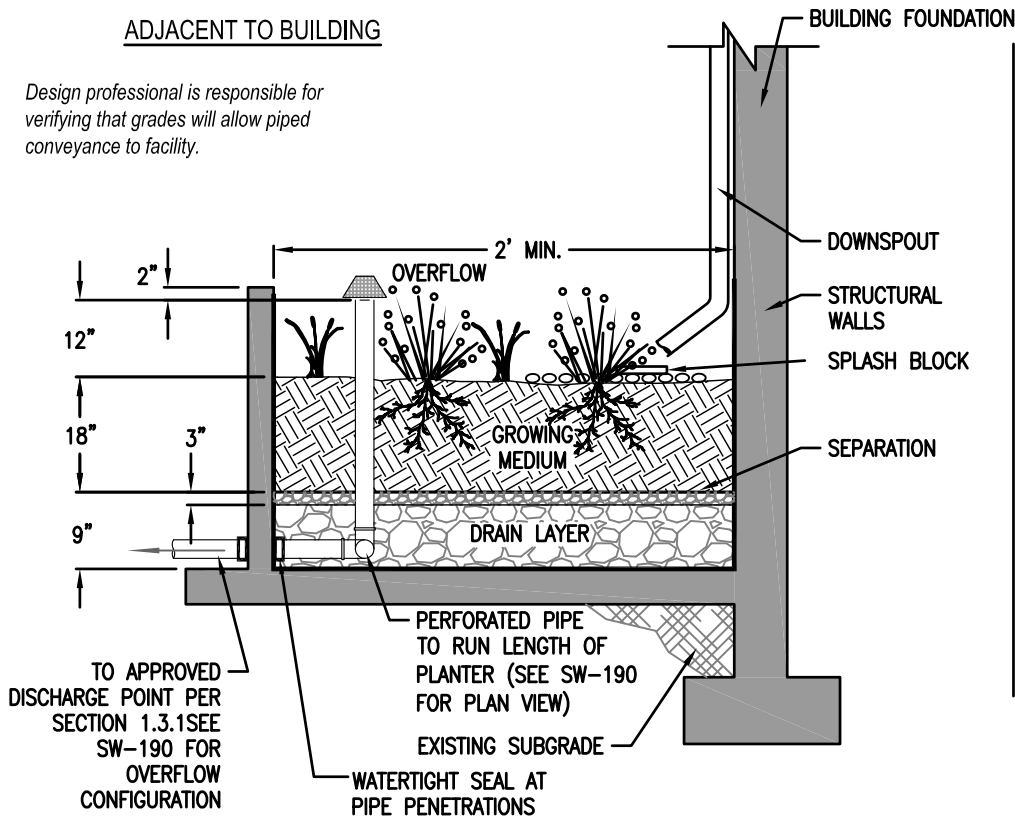

FREESTANDING PLANTER

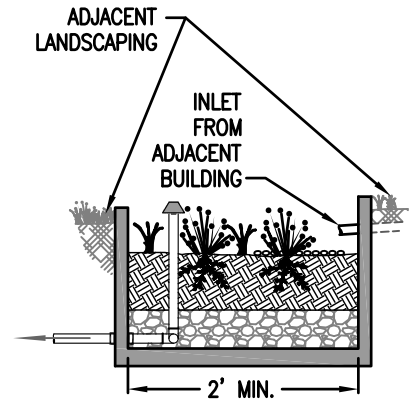

1. **Dimensions:**
Width of planter: 24" minimum.
Depth of planter (from top of growing medium to overflow elevation): 12".
Longitudinal slope of planter: 0.5% or less.
2. **Setbacks:**
Planters must be less than 30" in height above finish grade if within 5-feet of property line.
3. **Planter Walls:**
Material must be monolithically poured concrete. Walls must be included on foundation plans.
4. **Waterproofing:**
Monolithically poured planter, without joints is required. Check state structural requirements for foundations.
5. **Piping must be cast iron, ABS or PVC. 3" pipe required for facilities draining up to 1500 s.f., otherwise 4" minimum pipe. Uniform Plumbing Code also applies.**
6. **Drain Layer:**
3/4" - 1 1/2" washed round rock. Depth: 9".
Separation between drain rock and growing medium:
Pea gravel lens, 2 to 3 inches deep.
7. **Overflow:**
Planters must connect to approved discharge point according to section 1.3.1 and detail SW-190.
Inlet elevation must allow for 2" of freeboard, minimum.
Protect from debris and sediment with strainer or grate.
8. **Growing Medium:**
18" minimum depth. Use sand/loam/compost 3-way mix, or approved mix that will support healthy plants.
24" minimum depth is required if the lined facility is also meeting BDS landscape requirements.
9. **Vegetation:** Refer to plant list in SWMM section 2.4.1. Minimum container size is #1. # of plantings per 100sf of facility area:
80 herbaceous plants OR;
72 herbaceous plants and 4 small shrubs.
10. **Splash Block:** Install 4-6" washed river rock or splash pad for erosion control at inlets and downspout.
11. **Inspections:** Call BDS IVR Inspection Line, (503) 823-7000, request 487. 3 inspections required.

- DRAWING NOT TO SCALE -

STORMWATER MANAGEMENT TYPICAL DETAILS

- Simplified Design Approach -
Planter - lined



Bureau of Environmental Services



NUMBER

SW-140
7-1-16

Design professional is responsible for verifying that grades will allow piped conveyance to facility.

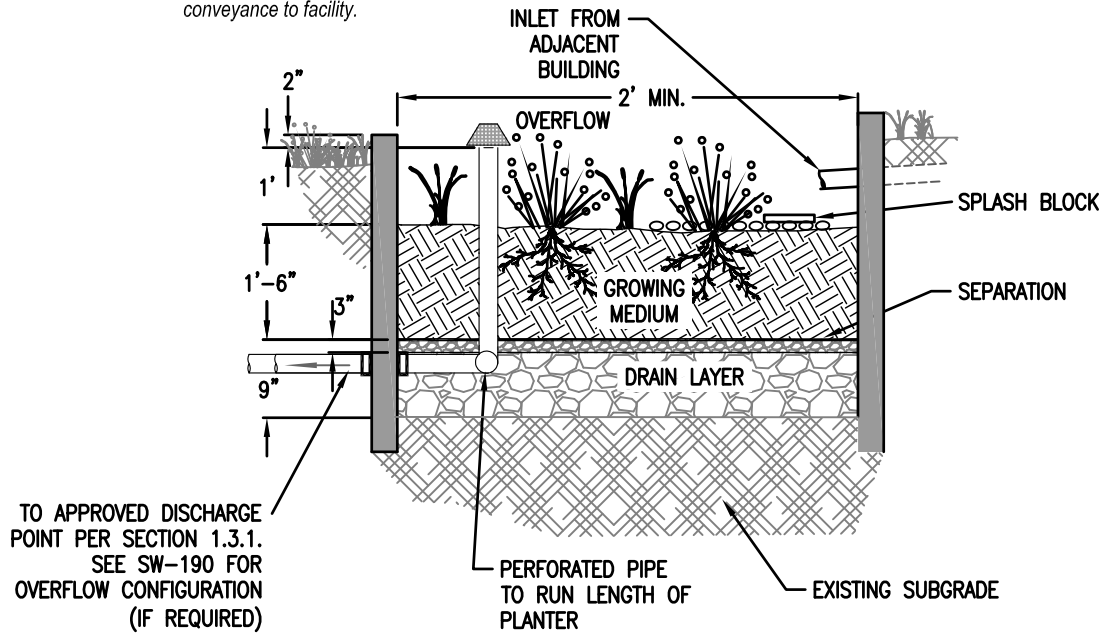

1. Provide protection from all vehicle traffic, equipment staging, and foot traffic in proposed infiltration areas prior to, during, and after construction.
2. Dimensions:
Width of planter: 24" minimum.
Depth of planter (from top of growing medium to overflow elevation): 12".
Longitudinal slope of planter: 0.5% or less.
3. Setbacks:
Planters must be 5-feet from property line and 10-feet from building foundations.
4. Planter Walls:
Material must be concrete, unless otherwise approved. Walls must be included on foundation plans.
5. Piping must be cast iron, ABS or PVC. 3" pipe required for facilities draining up to 1500 s.f., otherwise 4" minimum pipe. Uniform Plumbing Code also applies.
6. Drain Layer:
3/4" - 1 1/2" washed. Depth: 9".
Separation between drain rock and growing medium:
Pea gravel lens, 2 to 3 inches deep.
7. Overflow:
Planters must connect to approved discharge point according to section 1.3.1 and detail SW-190.
Inlet elevation must allow for 2" of freeboard, minimum.
Protect from debris and sediment with strainer or grate.
8. Growing Medium:
18" minimum depth. Use sand/loam/compost 3-way mix, or approved mix that will support healthy plants.
24" minimum depth is required if the lined facility is also meeting BDS landscape requirements.
9. Vegetation: Refer to plant list in SWMM Section 2.4.1. Minimum container size is #1. # of plantings per 100sf of facility area:
80 herbaceous plants OR;
72 herbaceous plants and 4 small shrubs.
10. Splash Block: Install 4-6" washed river rock or splash pad for erosion control at inlets and downspout.
11. Inspections: Call BDS I/R Inspection Line, (503) 823-7000, request 487. 3 inspections required.

- DRAWING NOT TO SCALE -

STORMWATER MANAGEMENT TYPICAL DETAILS

- Simplified Design Approach -
Planter - unlined



Bureau of Environmental Services



NUMBER

SW-141
7-1-16

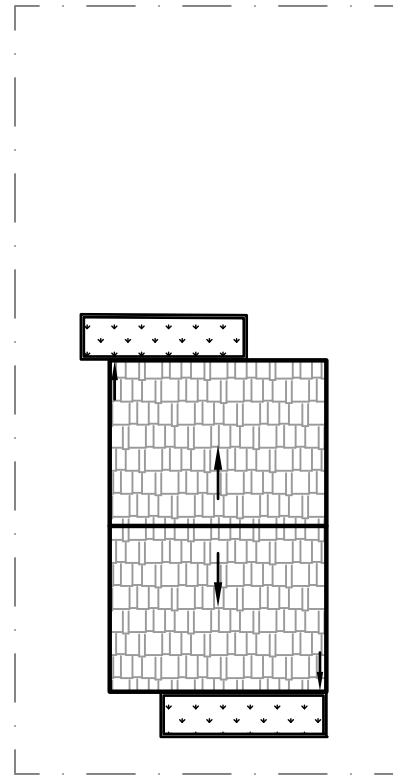
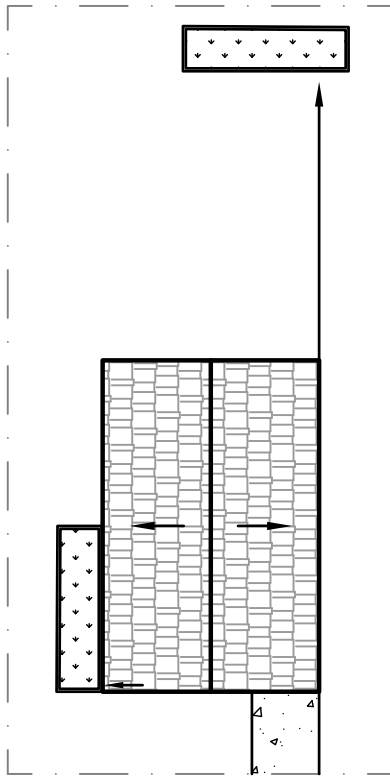

1. Drainage areas and corresponding planters can be divided to accommodate site and building configuration. Configurations shown are for example.
2. Design professional is responsible for verifying that grades will allow piped conveyance to facility.

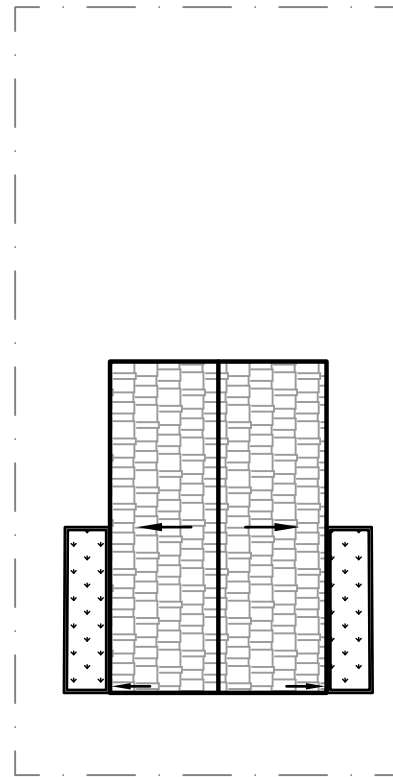

- DRAWING NOT TO SCALE -

STORMWATER MANAGEMENT TYPICAL DETAILS

- Simplified Design Approach -
Planter - site configurations



Bureau of Environmental Services



NUMBER

SW-142
7-1-16

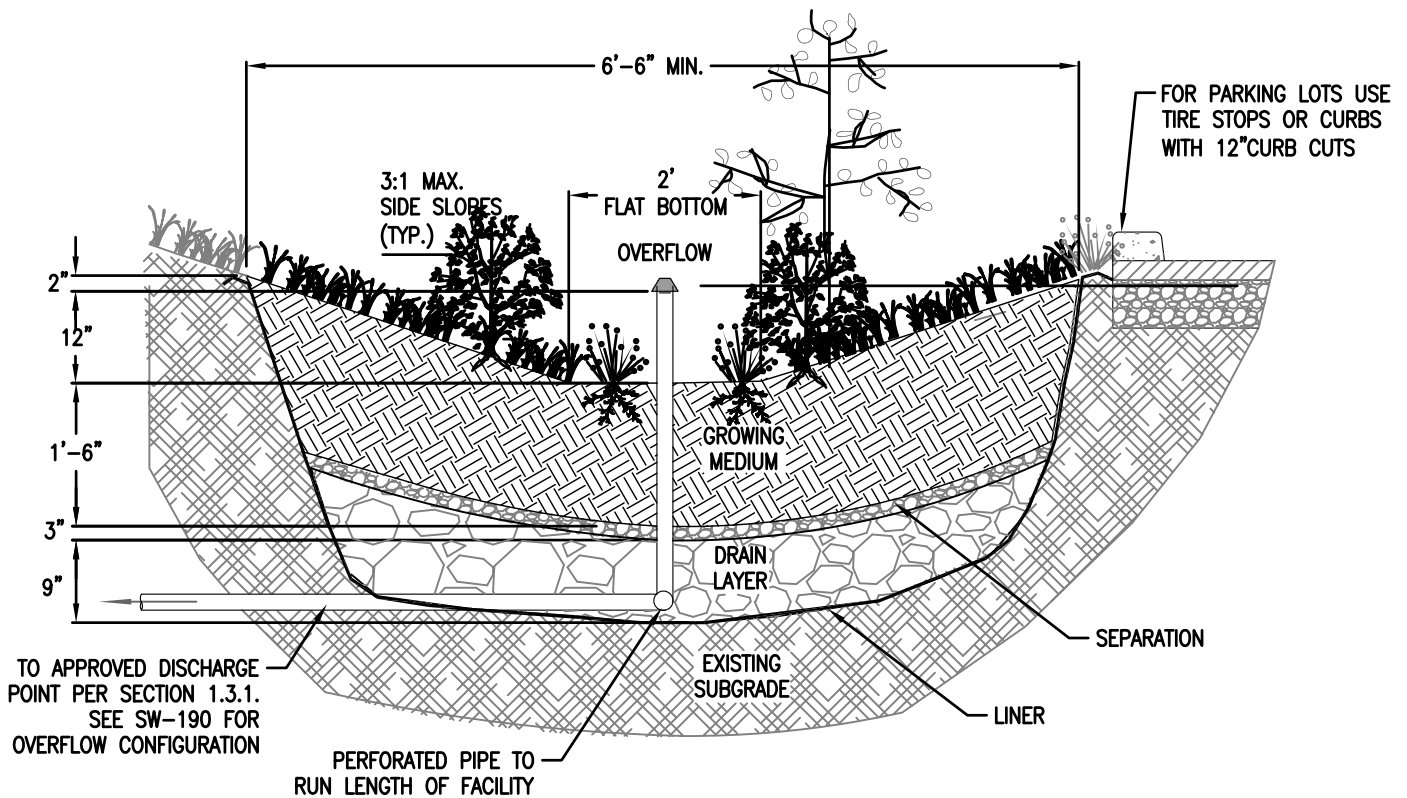

1. Dimensions:
Width of basin: 6'-6" minimum
Depth of basin (from top of growing medium to overflow elevation): 9".
Flat bottom width: 2' recommended.
Side slopes of swale: 3:1 maximum.
2. Setbacks: None required.
3. Overflow:
Basins must connect to approved discharge point according to SWMM Section 1.3.1.
Inlet elevation must allow for 2" of freeboard, minimum.
Protect from debris and sediment with strainer or grate.
4. Piping must be cast iron, ABS or PVC. 3" pipe required for facilities draining up to 1500 s.f., otherwise 4" minimum pipe. Uniform Plumbing Code also applies.
5. Drain Layer:
3/4" - 1 1/2" washed round rock. Depth: 9".
Separation between drain rock and growing medium:
Pea gravel lens, 2 to 3 inches deep.
6. Growing Medium:
18" minimum depth. Use sand/loam/compost 3-way mix, or approved mix that will support healthy plants.
24" minimum depth is required if the lined facility is also meeting BDS landscape requirements.
7. Vegetation: Follow landscape plans otherwise refer to plant list in SWMM Section 2.4.1. Minimum container size is #1. # of plantings per 100sf of facility area:
Zone A (wet): 80 herbaceous plants OR 72 herbaceous plants and 4 small shrubs.
Zone B (moderate to dry): 7 large or small shrubs AND 70 groundcover plants.
The delineation between Zone A and B must be either at the outlet elevation or the check dam elevation, whichever is lowest.
If project area is over 200sf consider adding a tree.
8. Waterproof Liner: 30 mil EPDM, HDPE or approved equivalent.
9. Splash Block: Install 4-6" washed river rock or splash pad for erosion control at inlets and downspout.
10. Inspections: Call BDS IVR Inspection Line, (503) 823-7000, request 487. 3 inspections required.

- DRAWING NOT TO SCALE -

STORMWATER MANAGEMENT TYPICAL DETAILS

- Simplified Design Approach -
Basin - lined



Bureau of Environmental Services



NUMBER

SW-150

7-1-16

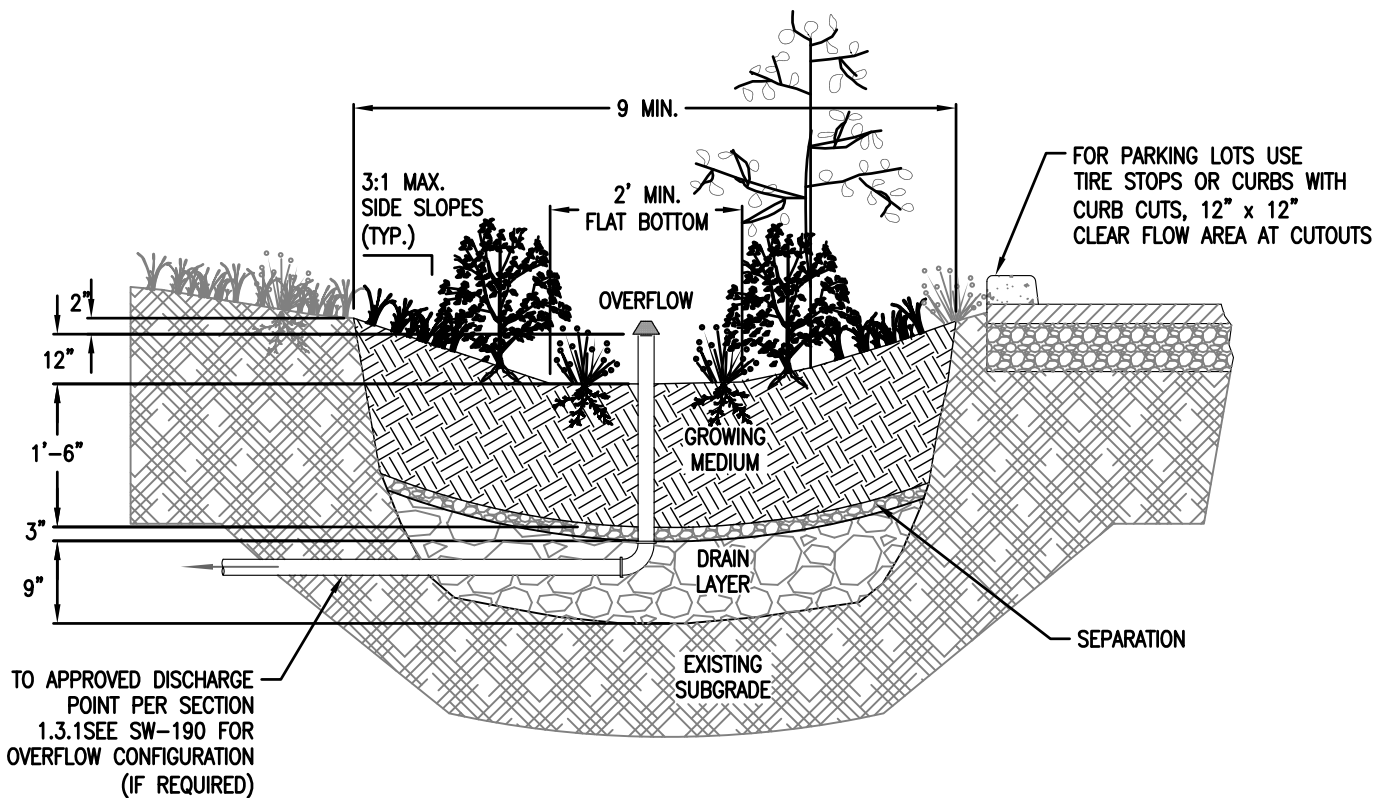

1. Provide protection from all vehicle traffic, equipment staging, and foot traffic in proposed infiltration areas prior to, during, and after construction.
2. Dimensions:
Width of basin: 9' minimum
Depth of basin (from top of growing medium to overflow elevation): 9".
Flat bottom width: 2' minimum.
Side slopes of swale: 3:1 maximum.
3. Setbacks:
Basin must be 10' away from foundations and 5' away from property lines.
4. Overflow:
Basins must connect to approved discharge point according to SWMM Section 1.3.1 and detail SW-190.
Inlet elevation must allow for 2" of freeboard, minimum.
Protect from debris and sediment with strainer or grate.
5. Piping must be cast iron, ABS or PVC. 3" pipe required for facilities draining up to 1500 s.f., otherwise 4" minimum pipe. Uniform Plumbing Code also applies.
6. Drain Layer:
3/4" - 1 1/2" washed rock. Depth: 9".
Separation between drain rock and growing medium: Pea gravel lens, 2 to 3 inches deep.
7. Growing Medium:
18" minimum depth. Use sand/loam/compost 3-way mix, or approved mix that will support healthy plants.
8. Vegetation: Follow landscape plans otherwise refer to plant list in SWMM section 2.4.1. Minimum container size is #1. # of plantings per 100sf of facility area:
Zone A (wet): 80 herbaceous plants OR 72 herbaceous plants and 4 small shrubs.
Zone B (moderate to dry): 7 large or small shrubs AND 70 groundcover plants.
The delineation between Zone A and B must be either at the outlet elevation or the check dam elevation, whichever is lowest. If project area is over 200sf consider adding a tree.
9. Splash Block: Install 4-6" washed river rock or splash pad for erosion control at inlets and downspout.
10. Inspections: Call BDS IVR Inspection Line, (503) 823-7000, request 487. 3 inspections required.

- DRAWING NOT TO SCALE -

STORMWATER MANAGEMENT TYPICAL DETAILS

- Simplified Design Approach -
Basin - unlined



Bureau of Environmental Services



NUMBER

SW-151

7-1-16

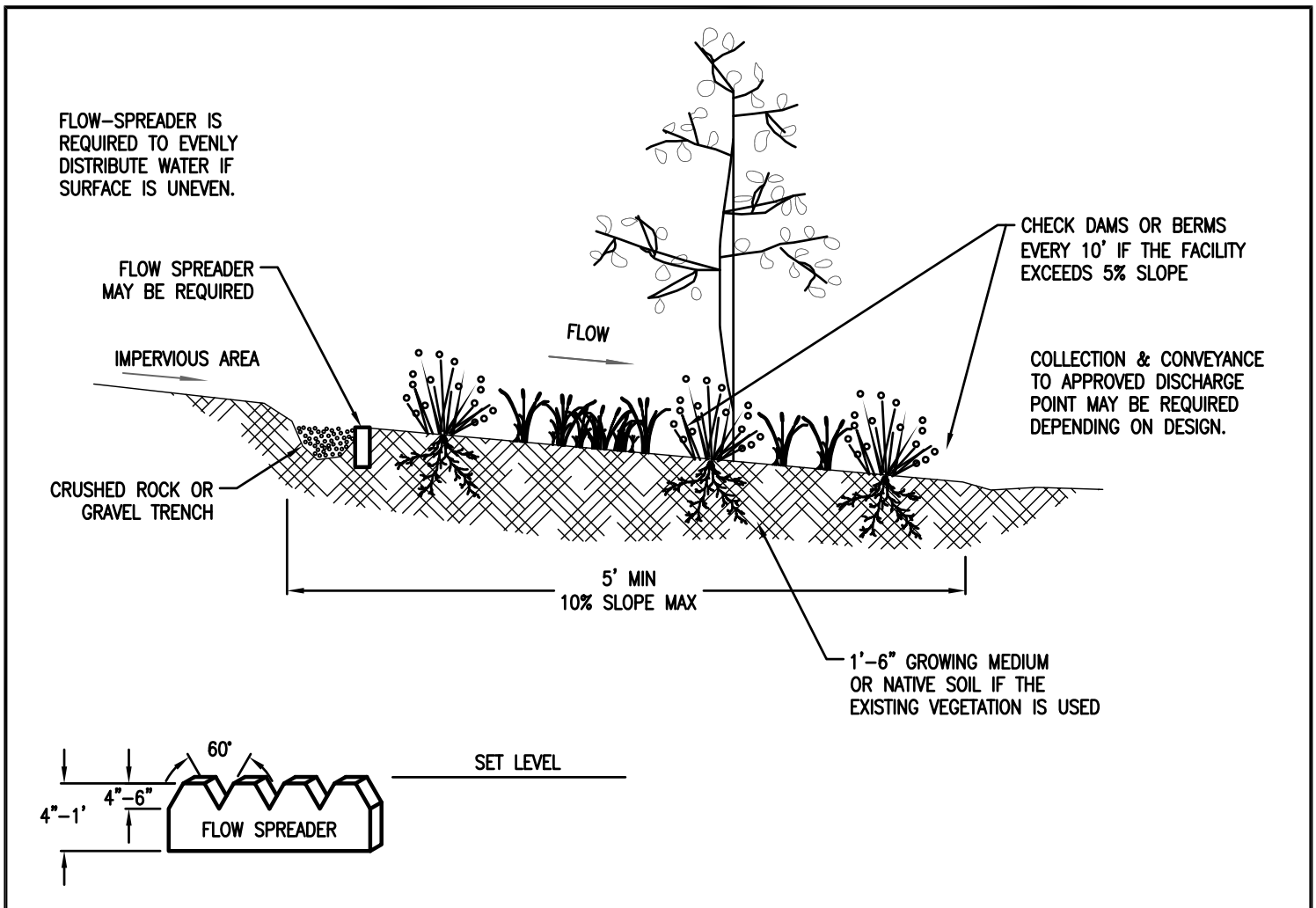

1. Provide protection from all vehicle traffic, equipment staging, as well as foot traffic for proposed infiltration areas prior to and during construction.
2. Dimensions:
 - a. Flow line length: 5' minimum.
 - b. Slopes: 0.5 - 10%
3. Setbacks (from beginning of facility):
 - a. 5' from property line
 - b. 10ft from buildings
 - c. 50ft from wetlands, rivers, streams, and creeks where required.
4. Overflow: Collection from filter strip shall be specified on plans to approved discharge point according to SWMM Section 1.3.
5. Growing Medium: Unless existing vegetated areas are used for the filter strip, growing medium shall be used within the top 18" (Use sand/loam/compost 3-way mix or approved mix that will support healthy plants).
6. Vegetation: The entire filter strip must have 100% coverage by native grasses, native wildflower blends, native ground covers, or any combination thereof.
7. Flow Spreaders: A grade board or sand/gravel trench may be required to disperse the runoff evenly across the filter strip to prevent a point of discharge. The top of the level spreader must be horizontal and at an appropriate height to provide sheetflow directly to the soil without scour. Level spreaders shall not hold a permanent volume of runoff. Grade boards can be made of any material that will withstand weather and solar degradation. Trenches used as level spreaders can be filled with washed crushed rock, pea gravel, or sand
8. Check Dams: shall be placed according to facility design otherwise:
 - a. 12" in length
 - b. Equal to the width of the filter
 - c. 3 to 5" in height
 - d. Every 10' where slope exceeds 5%.
9. Inspections: call BDS IVR Inspection Line, (503) 823-7000, for appropriate inspections.

- DRAWING NOT TO SCALE -

STORMWATER MANAGEMENT TYPICAL DETAILS

- Simplified Design Approach -
Filter Strip



Bureau of Environmental Services



NUMBER

SW-160
7-1-16

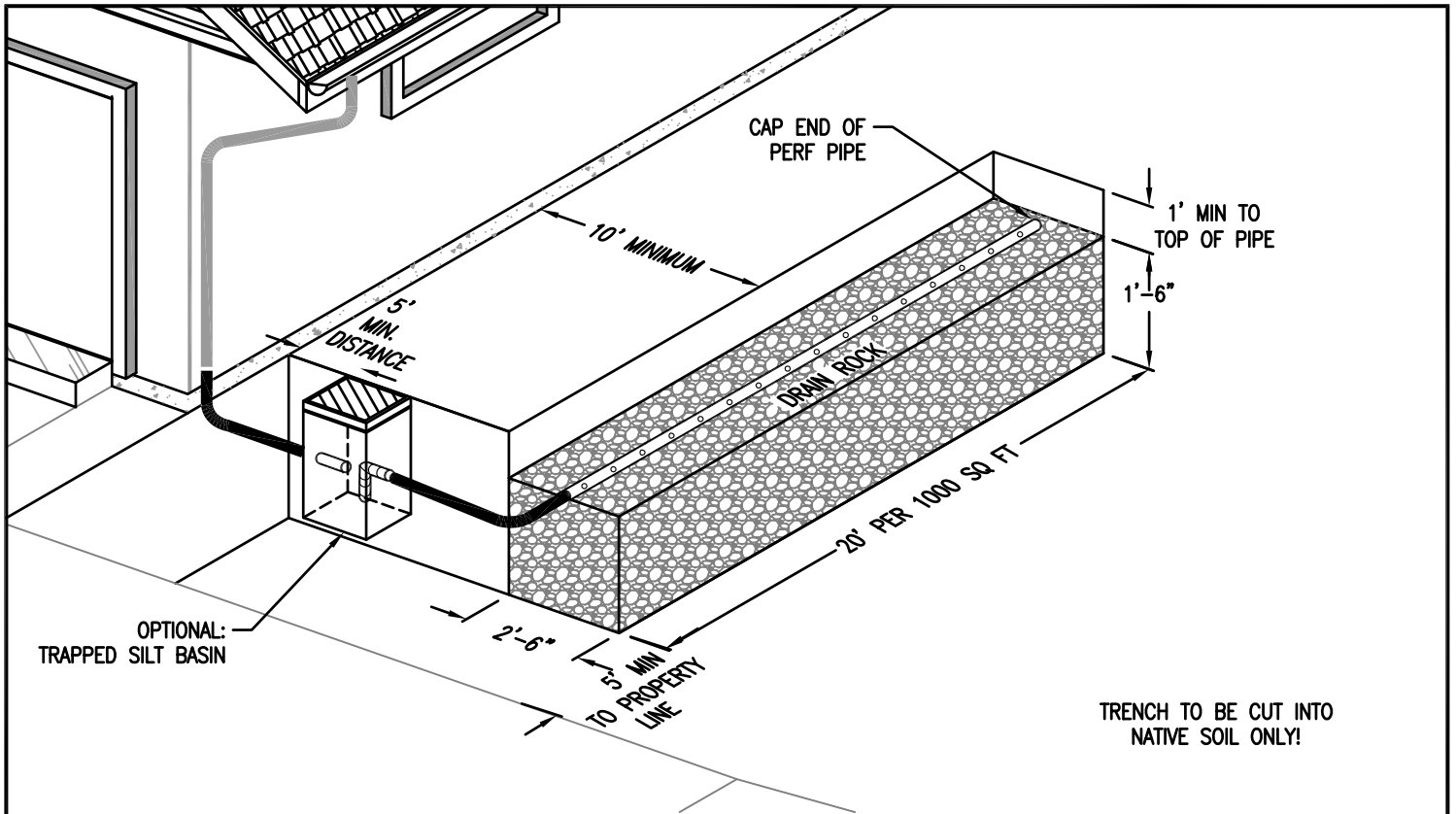

DETAIL B: SOAKAGE TRENCH CONSTRUCTION

1. Provide protection from all vehicle traffic, equipment staging, and foot traffic in proposed infiltration areas prior to, during and after construction.
2. Siting Criteria: Infiltration rate must be 2" per hour minimum. Soakage trench shall not be placed where base of facility has less than 5' of separation to water table.
3. Sizing: 2'-6" wide x 1'-6" tall x 20' long per 1000 square feet of impervious surface.
4. Setbacks: Soakage trench must be 10' from foundations, 5' from property lines, and 20' from cesspools.
5. Piping must be cast iron, ABS or PVC. 3" pipe required for facilities draining up to 1500 sf, otherwise 4" minimum pipe. Uniform Plumbing Code also applies.
6. Trapped Silt Basin: Optional for roof runoff or pedestrian only paved areas.

FILTER FABRIC TO BE PLACED ON SIDES AND ENDS. TO FOLD OVER AND COVER PERF PIPE AND DRAIN ROCK.

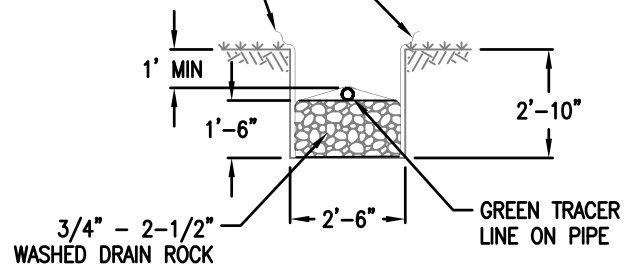

LINE TRENCH SIDES WITH PERMEABLE FILTER FABRIC AS SHOWN, ADD 18" OF DRAIN ROCK. PLACE PERF. PIPE AND COVER ALL.

- DRAWING NOT TO SCALE -

STORMWATER MANAGEMENT TYPICAL DETAILS

- Simplified Design Approach -
Soakage Trench



Bureau of Environmental Services



NUMBER
SW-170
7-1-16

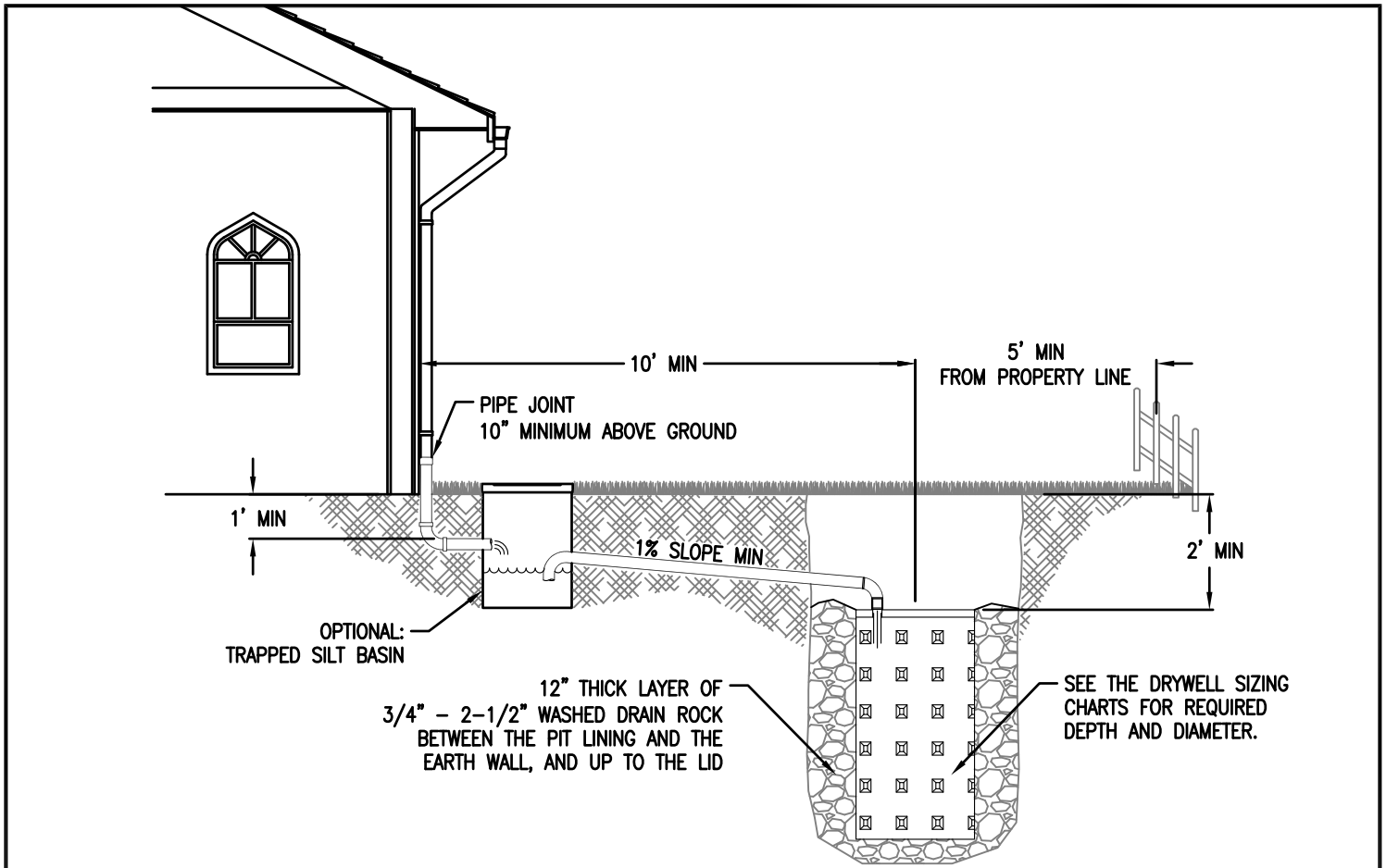

1. Provide protection from all vehicle traffic, equipment staging, and foot traffic in proposed infiltration areas prior to, during and after construction.
2. Siting Criteria: Gravelly sand, gravelly loamy sand or other equally porous material must occur in a continuous 5' deep stratum within 12' of the ground surface. Drywell shall not be placed where base of facility has less than 5' of separation to water table.
3. Sizing: Exhibit 2-36 is used to size the drywell(s) based on impervious area.
4. Top of drywell must be below lowest finished floor.
5. Setbacks: Drywell must be 10' from foundations, 5' from property lines, and 20' from cesspools.
6. Piping must be cast iron, ABS or PVC. 3" pipe required for facilities draining up to 1500 sf, otherwise 4" minimum pipe. Uniform Plumbing Code also applies.
7. Trapped Silt Basin: Optional for roof runoff or pedestrian only paved areas.

Exhibit 2-36: Drywell Sizing Table

Once approval has been given by BES for onsite infiltration of stormwater, the following chart shall be used to select the number and size of drywells. Gray boxes are acceptable.

IMPERVIOUS Area (sq-ft)	28" Diameter				48" Diameter			
	Drywell Depth							
	5'	10'	15'	20'	5'	10'	15'	20'
1000								
2000								
3000								
4000								
5000								
6000								
7000								
8000								
9000								
10000								

- DRAWING NOT TO SCALE -

STORMWATER MANAGEMENT TYPICAL DETAILS

- Simplified Design Approach -
Drywell

NUMBER
SW-180
7-1-16



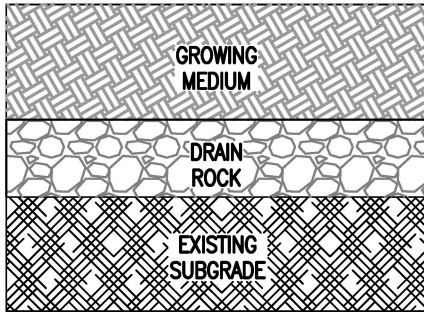

INFILTRATION
STORMWATER HIERARCHY CATEGORY 1

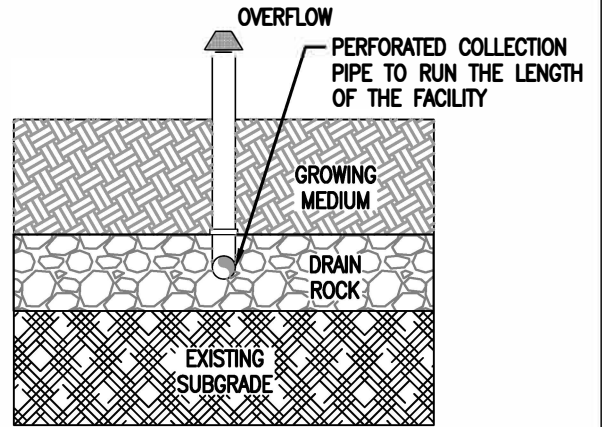

HYBRID
STORMWATER HIERARCHY CATEGORY 2
OVERFLOW DIRECTED TO DRAIN ROCK.

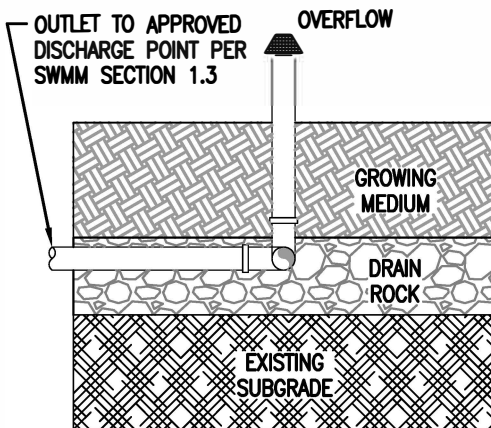

PARTIAL INFILTRATION
STORMWATER HIERARCHY CATEGORY 3 or 4
OVERFLOW AND UNDERDRAIN REQUIRED.
SET UNDERDRAIN WITHIN DRAIN ROCK

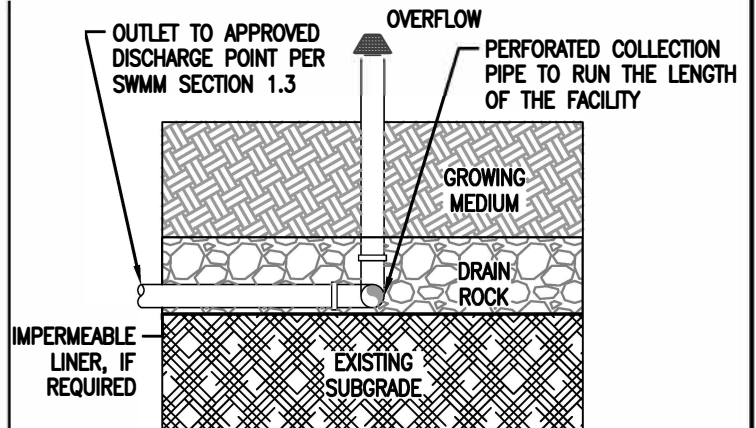

LINED
STORMWATER HIERARCHY CATEGORY 3 or 4
OVERFLOW AND UNDERDRAIN REQUIRED.
SET UNDERDRAIN AT BASE OF DRAIN ROCK LINER.

NOTE: Hybrid facilities must be registered as a UIC designed under the presumptive approach.

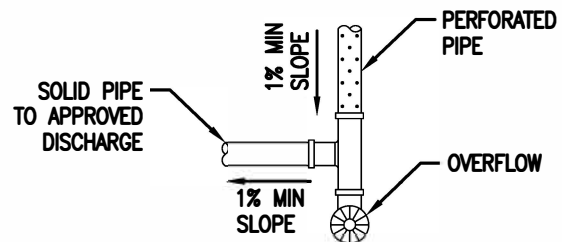

PLAN VIEW
PIPE W/ UNDERDRAIN & DISCHARGE POINT

- DRAWING NOT TO SCALE -

STORMWATER MANAGEMENT TYPICAL DETAILS

- Simplified Design Approach -
Facility Overflow Configurations



Bureau of Environmental Services



NUMBER

SW-190

7-1-16

2.3.5 Private Presumptive and Performance Stormwater Facility Typical Details

Table of Contents

SW-200 - Ecoroof
SW-201 - Habitat Ecoroof
SW-210 - Pervious Pavement
SW-220 - Swale - Lined
SW-221 - Swale - Unlined
SW-230 - Planter - Lined
SW-231 - Planter - Unlined
SW-240 - Basin - Lined
SW-241 - Basin - Unlined
SW-250 - Facility Overflow Configurations
SW-251 - Facility Overflow Configuration E
SW-252 - Facility Overflow Configuration F
SW-260 - Filter Strip
SW-270 - Soakage Trench
SW-280 - Drywell
SW-290 - Sand Filter - Infiltration
SW-291 - Sand Filter - Sub-Surface

- DRAWING NOT TO SCALE -

STORMWATER MANAGEMENT TYPICAL DETAILS

Presumptive and Performance Facilities
Table of Contents



Bureau of Environmental Services



NUMBER

TOC
7-1-16

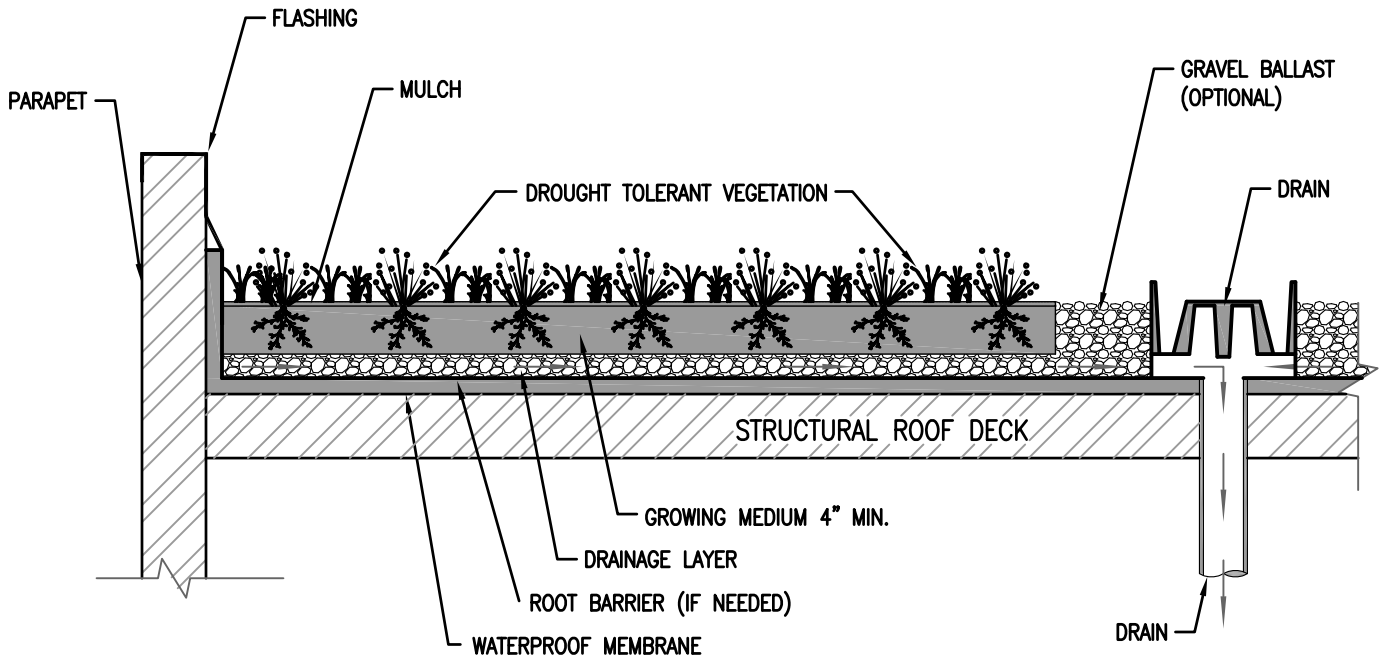

ECOROOF WITH DRAINAGE LAYER

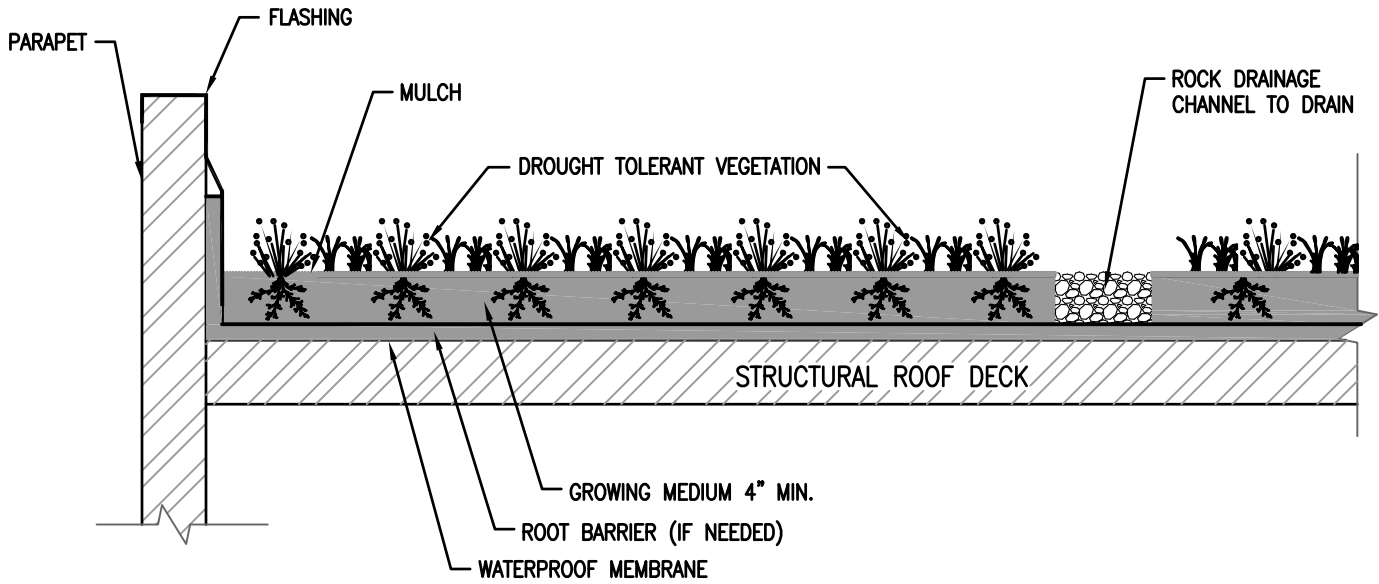

ECOROOF WITH DRAINAGE CHANNELS

- DRAWING NOT TO SCALE -

STORMWATER MANAGEMENT TYPICAL DETAILS

- Performance Design Approach -
Ecoroof

NUMBER

SW-200
7-1-16



Bureau of Environmental Services



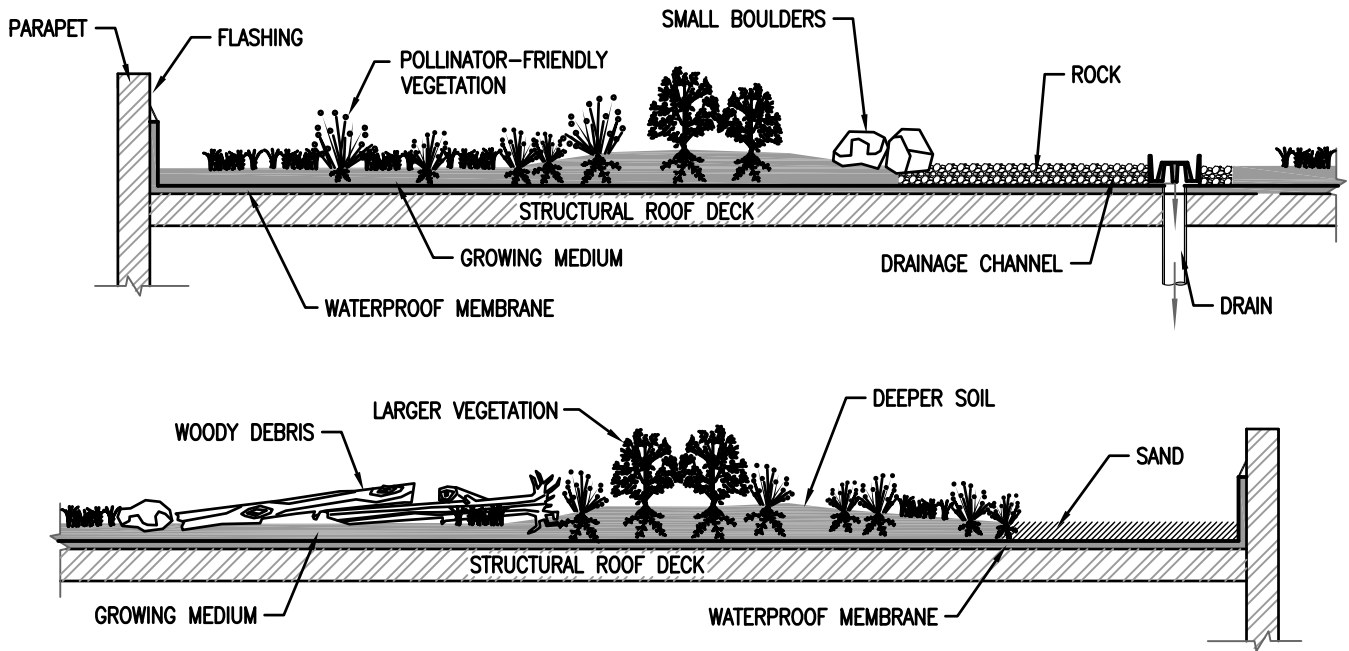

HABITAT ECOROOF EXAMPLE SECTIONS

NOTE: Building elements such as glass and lighting placed near ecoroofs have the potential to exacerbate bird-strike mortality. BES recommends designs comply with Portland's Resource Guide for Bird-Friendly Building Design: <http://www.portlandoregon.gov/bps/article/446308>

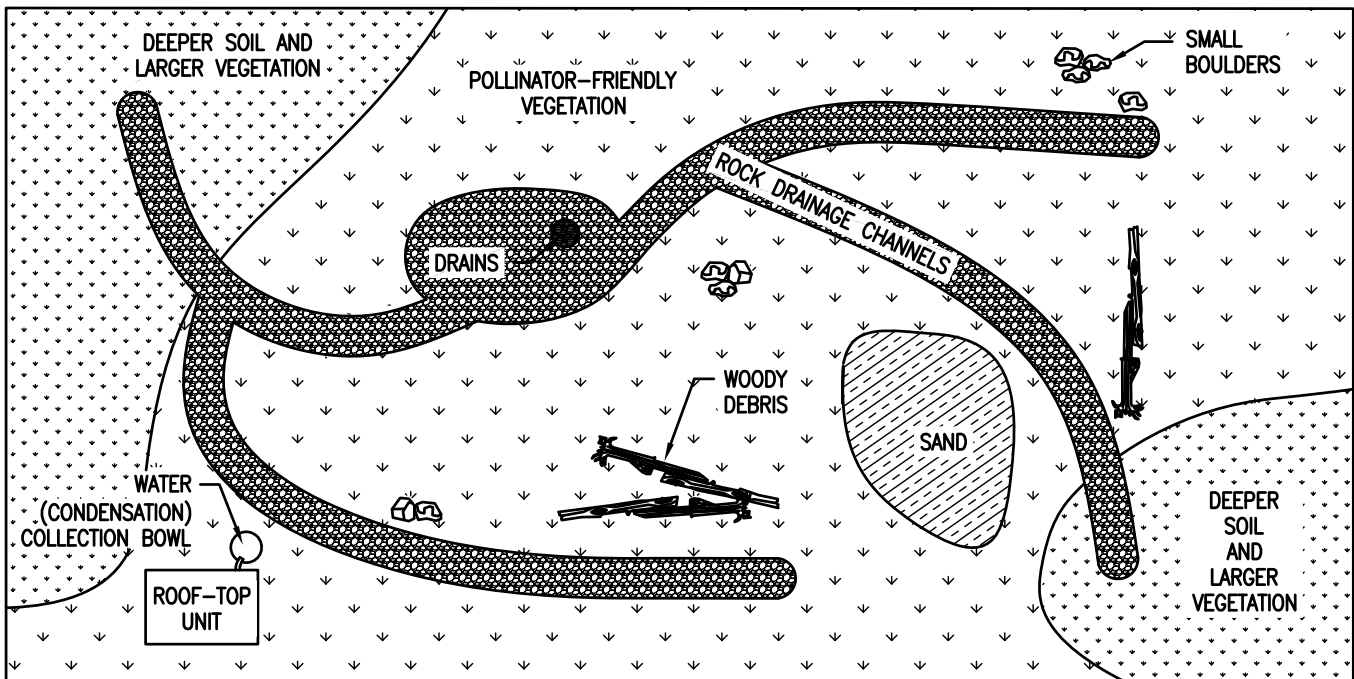

HABITAT ECOROOF WITH DRAINAGE CHANNELS - EXAMPLE PLAN

- DRAWING NOT TO SCALE -

STORMWATER MANAGEMENT TYPICAL DETAILS

- Performance Design Approach -
Habitat Ecoroof



Bureau of Environmental Services



NUMBER

SW-201
7-1-16

DETAIL INTENDED AS AN EXAMPLE. DETAIL MUST MATCH PAC ASSUMPTIONS AND/OR DESIGN REPORT.

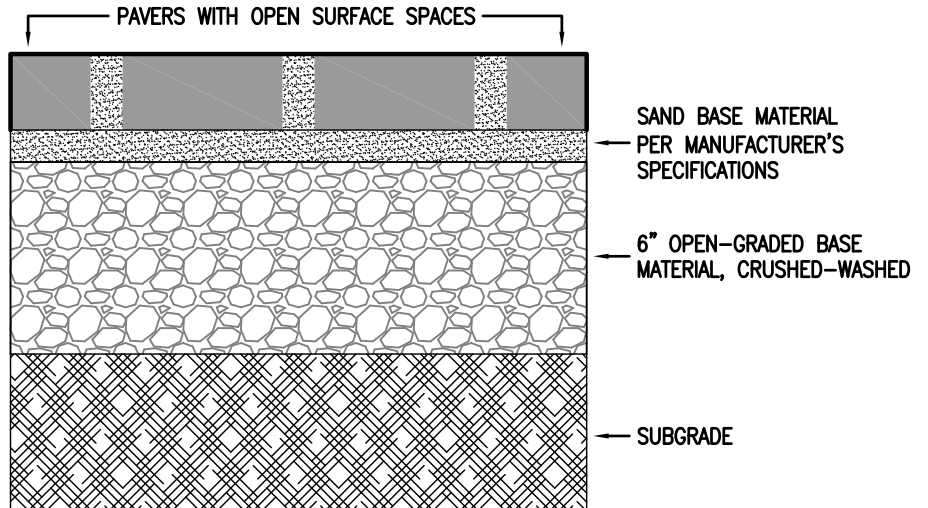

PERMEABLE CONCRETE BLOCK
OR "PAVER" SYSTEMS

1. Detail intended as an example. Detail must match design report.
2. Pervious pavement for public streets is a case-by-case basis.
3. For all applications, pavement designs must be prepared by a registered professional engineer.

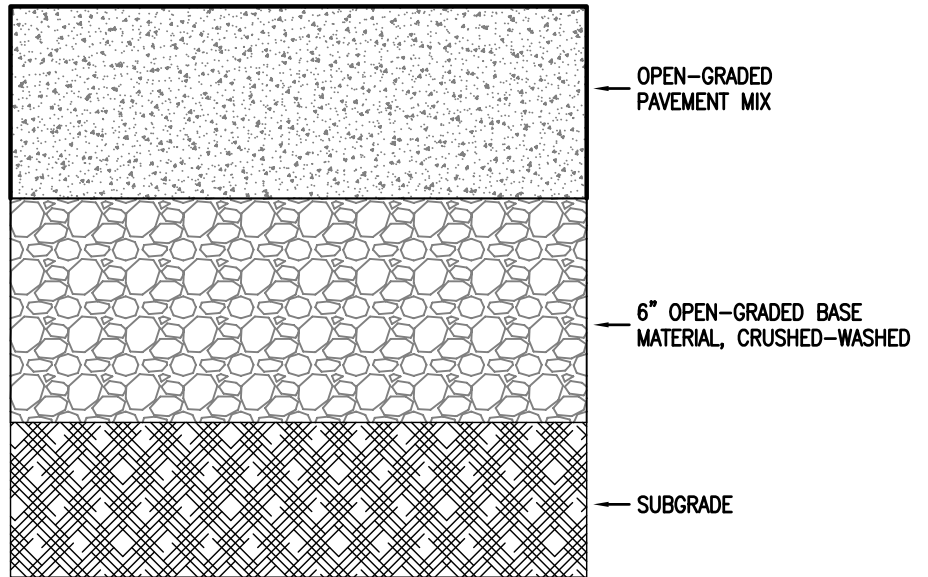

PERVIOUS (OPEN GRADED) CONCRETE
AND ASPHALT SYSTEMS

- DRAWING NOT TO SCALE -

STORMWATER MANAGEMENT TYPICAL DETAILS

- Performance Design Approach -
Pervious Pavement



Bureau of Environmental Services



NUMBER
SW-210
7-1-16

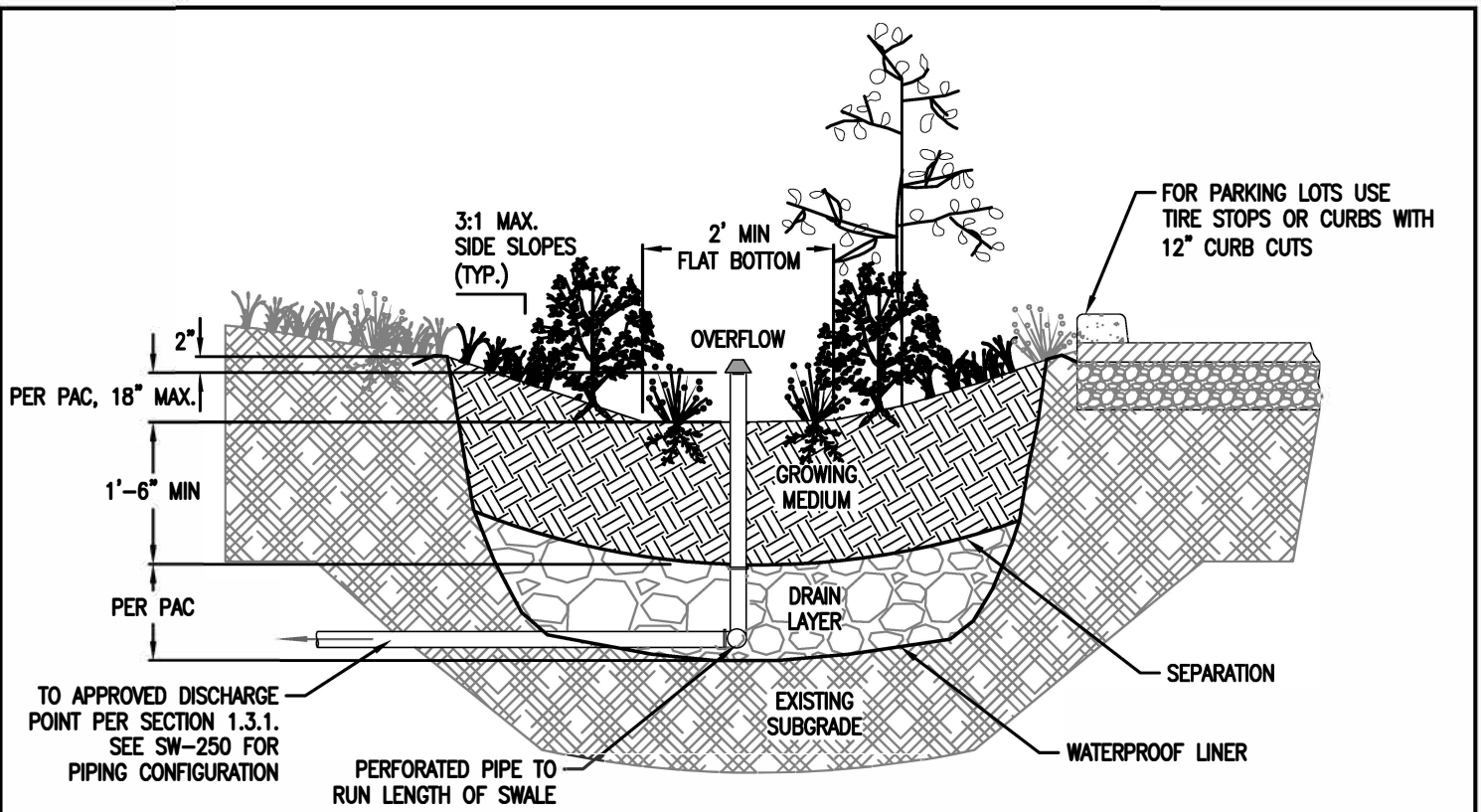

NOTES:

1. Detail intended as an example. Detail must match PAC assumptions and/or design report.
2. Dimensions:
 Width of swale: 6'-6" minimum
 Depth of swale (from top of growing medium to overflow elevation): per PAC
 Longitudinal slope of swale: 6.0% or less.
 Flat bottom width: 2' minimum.
 Side slopes of swale: per PAC, 3:1 maximum.
3. Setbacks:
 None required.
4. Overflow:
 Swales must connect to approved discharge point according to SWMM Section 1.3.1.
 Inlet elevation must allow for 2" of freeboard, minimum.
 Protect from debris and sediment with strainer or grate.
5. Piping must be ABS Sch.40, cast iron, or PVS Sch.40. 3" pipe required for facilities draining up to 1500 s.f., otherwise 4" min. pipe. Piping must have 1% grade and follow the Uniform Plumbing Code.
6. Drain Layer:
 Determined by designer. Options include, but are not limited to drain mat, 3/4" washed round rock, or other approved system.

Separation between drain and growing medium:
 Use appropriate filter fabric or a gravel lens (3/4 - 1/4 inch washed, rock 2 to 3 inches deep), or as per approved design.

7. Growing Medium:
 18" minimum depth. Use sand/loam/compost 3-way mix, or approved mix that will support healthy plants.
 24" minimum depth is required if the lined facility is also meeting BDS landscape requirements.
8. Vegetation: Follow landscape plans otherwise refer to plant list in SWMM, Section 2.4.1. Minimum container size is #1 container. # of plantings per 100sf of facility area:
 Zone A (wet): 80 herbaceous plants OR 72 herbaceous plants and 4 small shrubs.
 Zone B (moderate to dry): 7 large or small shrubs AND 70 groundcover plants.
 The delineation between Zone A and B must be either at the outlet elevation or the check dam elevation, whichever is lowest. If project area is over 200 sf consider adding a tree.
9. Check Dams: Must be placed per PAC and be equal to the width of the swale.
10. Waterproof Lner: 30 mil EPDM, HDPE or approved equivalent.
11. Splash Block: Install 4-6" washed river rock or splash pad for erosion control at inlets and downspout.
12. Inspections: Call BDS NR Inspection Line, (503) 823-7000, request 487. 3 inspections required.

- DRAWING NOT TO SCALE -

STORMWATER MANAGEMENT TYPICAL DETAILS

- Presumptive and Performance Design Approach -
 Swale - lined



Bureau of Environmental Services



NUMBER
 SW-220
 7-1-16

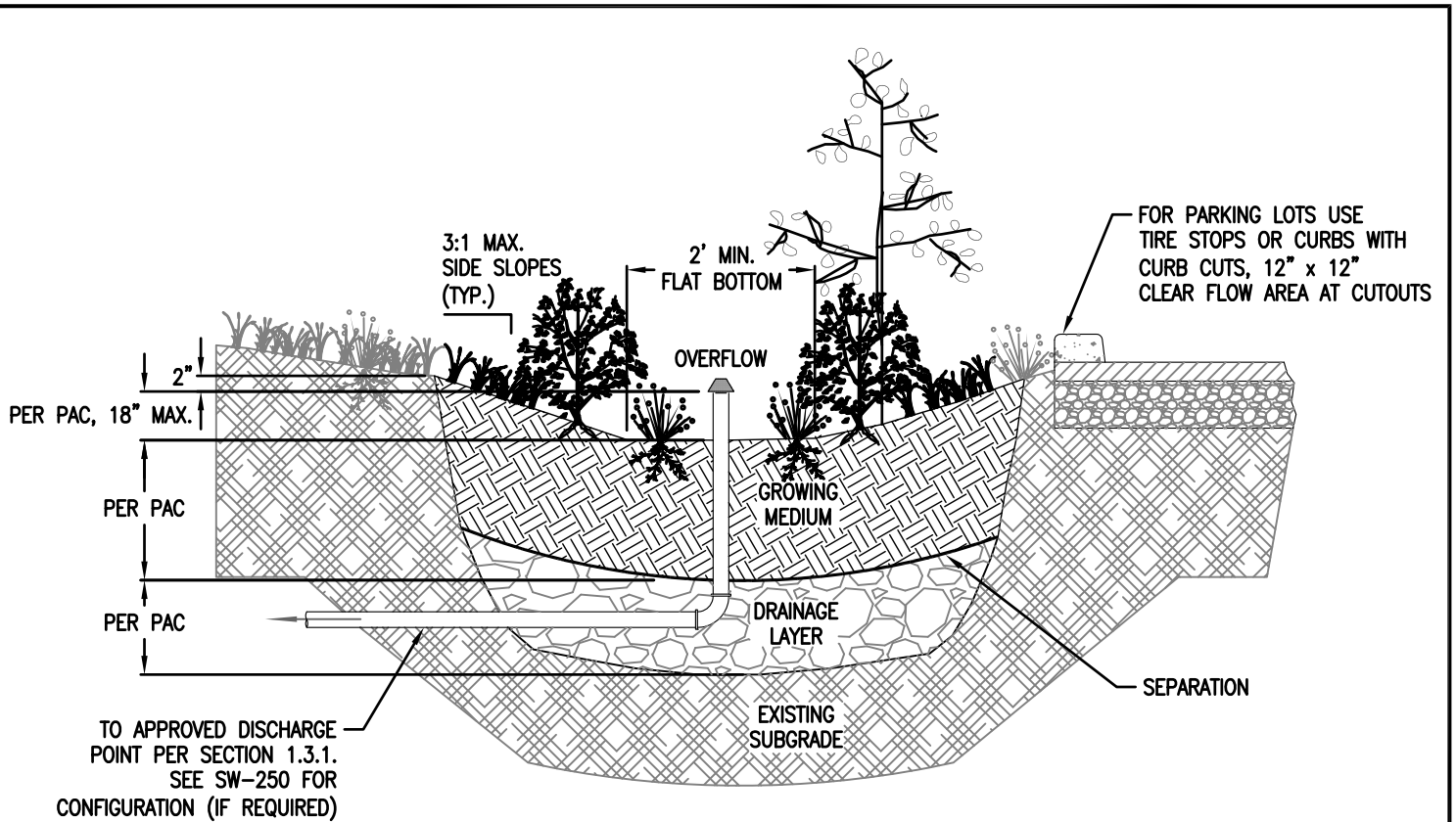

1. Detail intended as an example. Detail must match PAC assumptions and/or design report.
2. Provide protection from all vehicle traffic, equipment staging, and foot traffic in proposed infiltration areas prior to, during, and after construction.
3. Dimensions:
Width of swale: 6'-6" minimum
Depth of swale (from top of growing medium to overflow elevation): per PAC
Longitudinal slope of swale: 6.0% or less.
Flat bottom width: 2' minimum.
Side slopes of swale: per PAC, 3:1 maximum.
4. Setbacks:
Swale must be 10' away from foundation and 5' away from property lines.
5. Overflow:
Swales must connect to approved discharge point according to SWMM Section 1.3.
Inlet elevation must allow for 2" of freeboard, minimum.
Protect from debris and sediment with strainer or grate.
6. Piping must be ABS Sch.40, cast iron, or PVS Sch.40. 3" pipe required for facilities draining up to 1500 s.f., otherwise 4" min. pipe. Piping must have 1% grade and follow the Uniform Plumbing Code.
7. Drain Layer: If needed 3/4" - 1 1/2" washed rock or as approved. Depth per PAC.
8. Separation between drain rock and growing medium: if needed pea gravel lens, 2 to 3 inches deep or as approved.
9. Growing Medium:
Use sand/loam/compost 3-way mix, or approved mix that will support healthy plants. 18" minimum depth if there is a drainage layer. If soils are well draining and there is not a drainage layer depth may be reduced as approved.
10. Vegetation: Follow landscape plans otherwise refer to plant list in SWMM, section 2.4.1. Minimum container size is #1 container. # of plantings per 100sf of facility area:
Zone A (wet): 80 herbaceous plants OR 72 herbaceous plants and 4 small shrubs.
Zone B (moderate to dry): 7 large or small shrubs AND 70 groundcover plants.
The delineation between Zone A and B must be either at the outlet elevation or the check dam elevation, whichever is lowest. If project area is over 200sf consider adding a tree.
11. Check Dams: Must be placed per PAC and be equal to the width of the swale.
12. Splash Block: Install 4-6" washed river rock or splash pad for erosion control at inlets and downspout.
13. Inspections: Call BDS IVR Inspection Line, (503) 823-7000, request 487. 3 inspections required.

- DRAWING NOT TO SCALE -

STORMWATER MANAGEMENT TYPICAL DETAILS

- Presumptive and Performance Design Approach -
Swale - unlined



Bureau of Environmental Services



NUMBER

SW-221
7-1-16

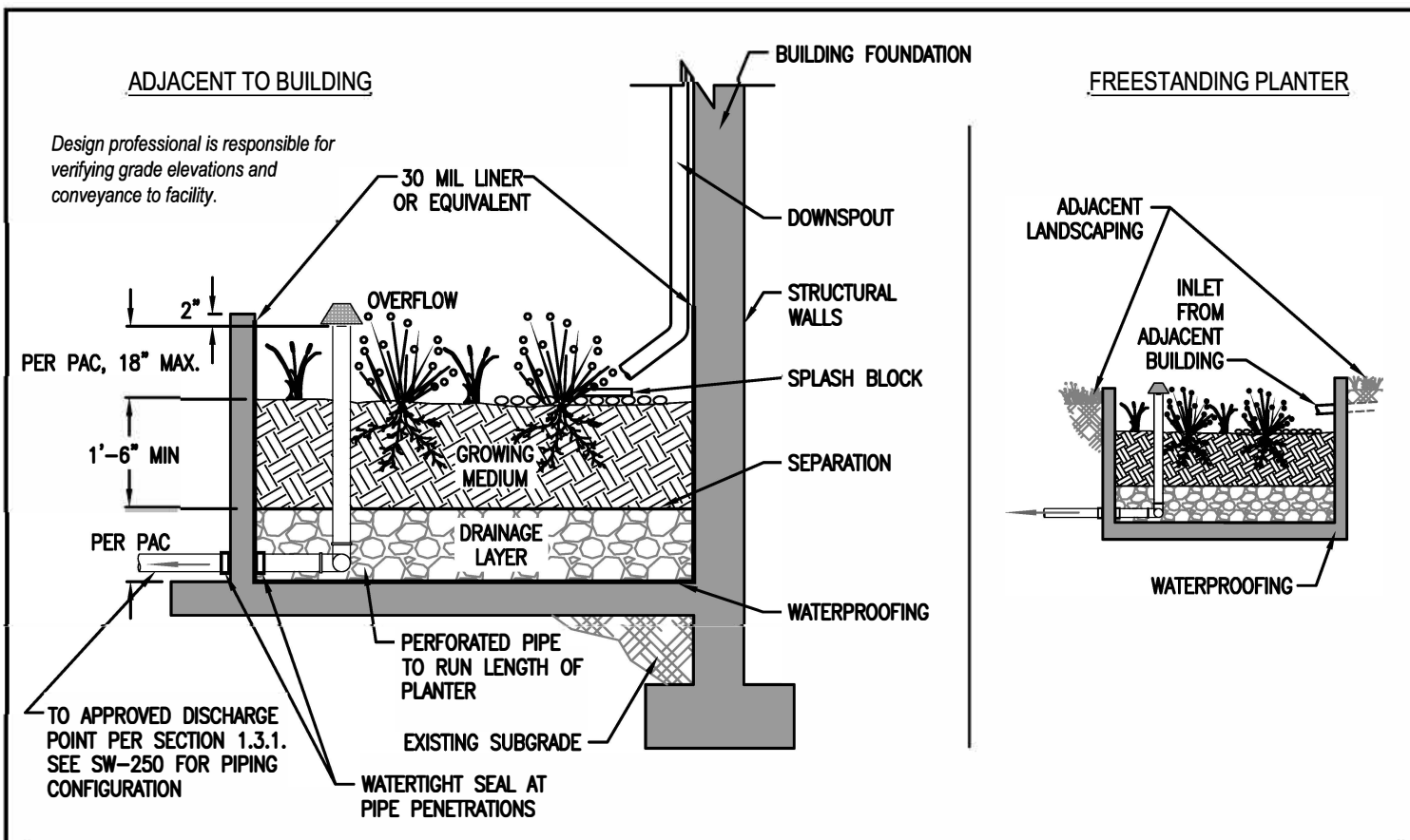

1. Detail intended as an example. Detail must match PAC assumptions and/or design report.
2. Dimensions:
Width of planter: 24" minimum.
Depth of planter (from top of growing medium to overflow elevation): per PAC calculations.
Longitudinal slope of planter: 0.5% or less.
3. Setbacks:
Planters must be less than 30" in height above finish grade if within 5-feet of property line.
4. Planter Walls:
Material must be monolithically poured concrete, unless otherwise approved. Walls must be included on foundation plans.
5. Waterproofing:
If planter is monolithically poured no additional liner/waterproofing is required. Check state structural requirements for foundations.
6. Piping must be ABS Sch.40, cast iron, or PVS Sch.40. 3" pipe required for facilities draining up to 1500 s.f., otherwise 4" min. pipe. Piping must have 1% grade and follow the Uniform Plumbing Code.
7. Drain Layer:
Determined by designer. Options include, but are not limited to drain mat, 3/4" washed round rock, or other approved system.
8. Separation between drain and growing medium:
Use appropriate filter fabric or a gravel lens (3/4 - 1/4 inch washed, crushed rock 2 to 3 inches deep), or as per approved design.
9. Overflow:
Inlet elevation must allow for 2" of freeboard, minimum. Protect from debris and sediment with strainer or grate.
10. Growing Medium:
18" minimum depth. Use sand/loam/compost 3-way mix, or approved mix that will support healthy plants.
24" minimum depth is required if the lined facility is also meeting BDS landscape requirements.
11. Vegetation: Refer to plant list in SWMM, Section 2.4.1. Minimum container size is #1 container. # of plantings per 100sf of facility area:
80 herbaceous plants OR;
72 herbaceous plants and 4 small shrubs.
12. Inspections: Call BDS MR Inspection Line, (503) 823-7000, request 487. 3 inspections required.

- DRAWING NOT TO SCALE -

STORMWATER MANAGEMENT TYPICAL DETAILS

- Presumptive and Performance Design Approach -
Planter - lined



Bureau of Environmental Services



NUMBER

SW-230
7-1-16

ADJACENT TO LANDSCAPING

Design professional is responsible for verifying that grades will allow piped conveyance to facility.

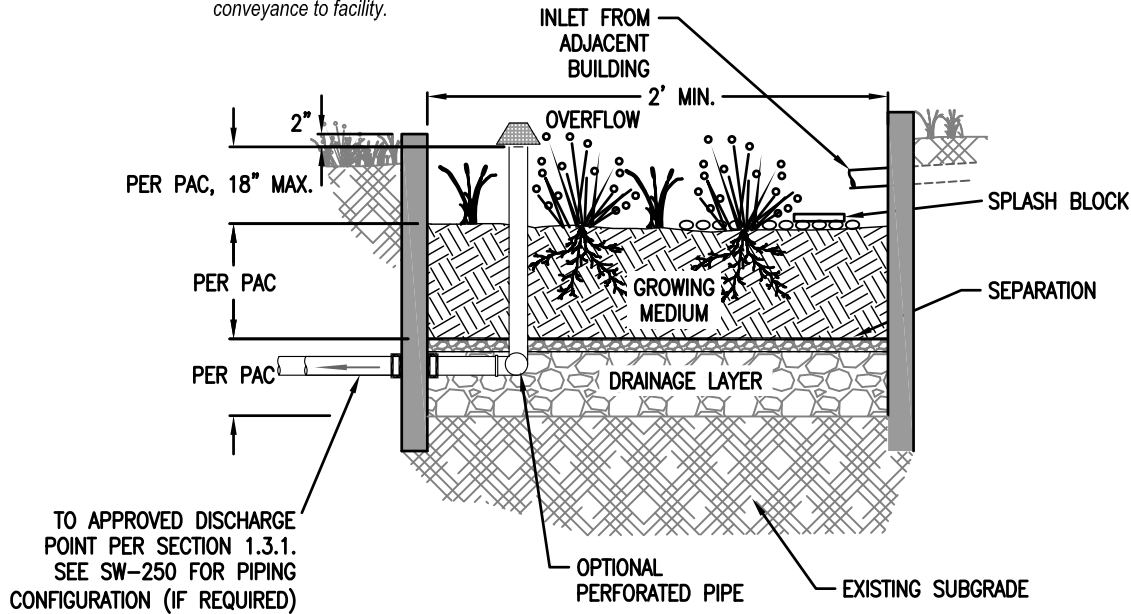

1. Detail intended as an example. Detail must match PAC assumptions and/or design report.
2. Provide protection from all vehicle traffic, equipment staging, and foot traffic in proposed infiltration areas prior to, during, and after construction.
3. Dimensions:
Width of planter: 24" minimum.
Depth of planter (from top of growing medium to overflow elevation): per PAC calculations.
Longitudinal slope of planter: 0.5% or less.
4. Setbacks:
Planters must be 5-feet from property line and 10-feet from building foundations.
5. Planter Walls:
Material must be concrete, unless otherwise approved.
6. Piping must be ABS Sch.40, cast iron, or PVS Sch.40. 3" pipe required for facilities draining up to 1500 s.f., otherwise 4" min. pipe. Piping must have 1% grade and follow the Uniform Plumbing Code.
7. Drain Layer:
Per PAC calculations. Options include, but are not limited to drain mat, 3/4" washed rock, or other approved system.
Separation between drain and growing medium:
Use appropriate filter fabric or a gravel lens (3/4 - 1/4 inch washed, crushed rock 2 to 3 inches deep), or as per approved design.
8. Overflow:
Inlet elevation must allow for 2" of freeboard, minimum.
Protect from debris and sediment with strainer or grate.
9. Growing Medium:
Use sand/loam/compost 3-way mix, or approved mix that will support healthy plants. 18" minimum depth if there is a drainage layer. If soils are well draining and there is not a drainage layer depth may be reduced as approved.
10. Vegetation: Refer to plant list in SWMM, Section 2.4.1. Minimum container size is #1 container. # of plantings per 100sf of facility area:
80 herbaceous plants OR;
72 herbaceous plants and 4 small shrubs.
11. Splash Block: Install 4-6" washed river rock or splash pad for erosion control at inlets and downspout.
12. Inspections: Call BDS IVR Inspection Line, (503) 823-7000, request 487. 3 inspections required.

- DRAWING NOT TO SCALE -

STORMWATER MANAGEMENT TYPICAL DETAILS

- Presumptive and Performance Design Approach -
Planter - unlined



Bureau of Environmental Services



NUMBER

SW-231
7-1-16

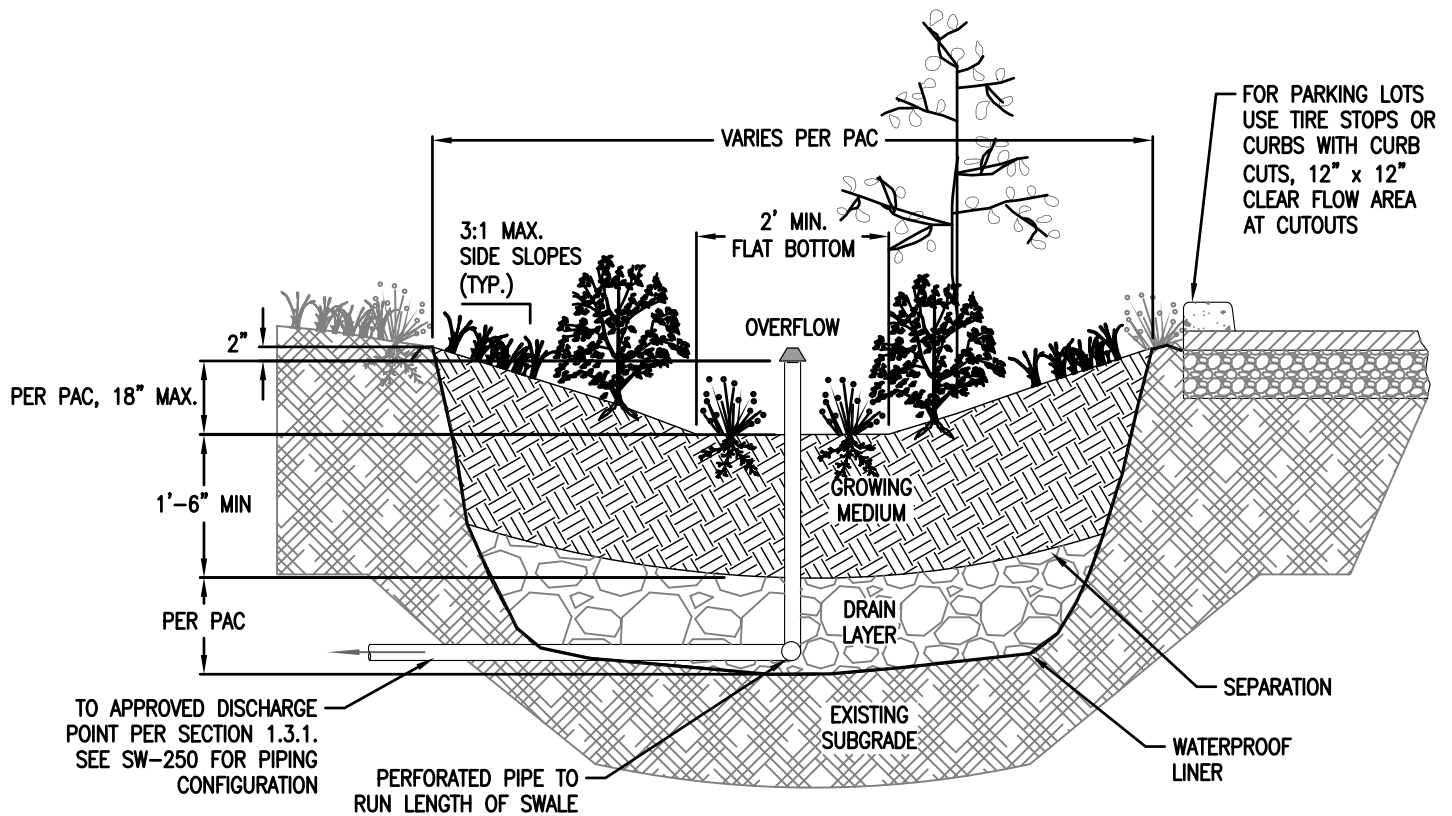

1. Detail intended as an example. Detail must match PAC assumptions and/or design report.
2. Dimensions:
 - Width of basin: 5' minimum
 - Depth of basin (from top of growing medium to overflow elevation): per PAC
 - Flat bottom width: 2' minimum.
 - Side slopes of swale: Per PAC, 3:1 maximum.
3. Setbacks: None required.
4. Overflow:
 - Basins must connect to approved discharge point according to SWMM Section 1.3.
 - Inlet elevation must allow for 2" of freeboard, minimum.
 - Protect from debris and sediment with strainer or grate.
5. Piping must be ABS Sch.40, cast iron, or PVS Sch.40. 3" pipe required for facilities draining up to 1500 s.f., otherwise 4" min. pipe. Piping must have 1% grade and follow the Uniform Plumbing Code.
6. Drain Layer:
 - Determined by designer. Options include, but are not limited to drain mat, 3/4" washed round rock, or other approved system.
7. Separation between drain and growing medium:
 - Use appropriate filter fabric or a gravel lens (3/4 - 1/4 inch washed, crushed rock 2 to 3 inches deep), or as per approved design.
8. Growing Medium:
 - 18" minimum depth. Use sand/loam/compost 3-way mix, or approved mix that will support healthy plants.
 - 24" minimum depth is required if the lined facility is also meeting BDS landscape requirements.
9. Vegetation: Follow landscape plans otherwise refer to plant list in SWMM Section 2.4.1. Minimum container size is #1 container. # of plantings per 100sf of facility area:
 - Zone A (wet): 80 herbaceous plants OR 72 herbaceous plants and 4 small shrubs.
 - Zone B (moderate to dry): 7 large or small shrubs AND 70 groundcover plants.
 - The delineation between Zone A and B shall be either at the outlet elevation or the check dam elevation, whichever is lowest.
 - If project area is over 200sf consider adding a tree.
10. Waterproof Liner: 30 mil EPDM, HDPE or approved equivalent.
11. Splash Block: Install 4-6" washed river rock or splash pad for erosion control at inlets and downspout.
12. Inspections: Call BDS IVR Inspection Line, (503) 823-7000, request 487. 3 inspections required.

- DRAWING NOT TO SCALE -

STORMWATER MANAGEMENT TYPICAL DETAILS

- Presumptive and Performance Design Approach -
Basin - lined



Bureau of Environmental Services



NUMBER

SW-240
7-1-16

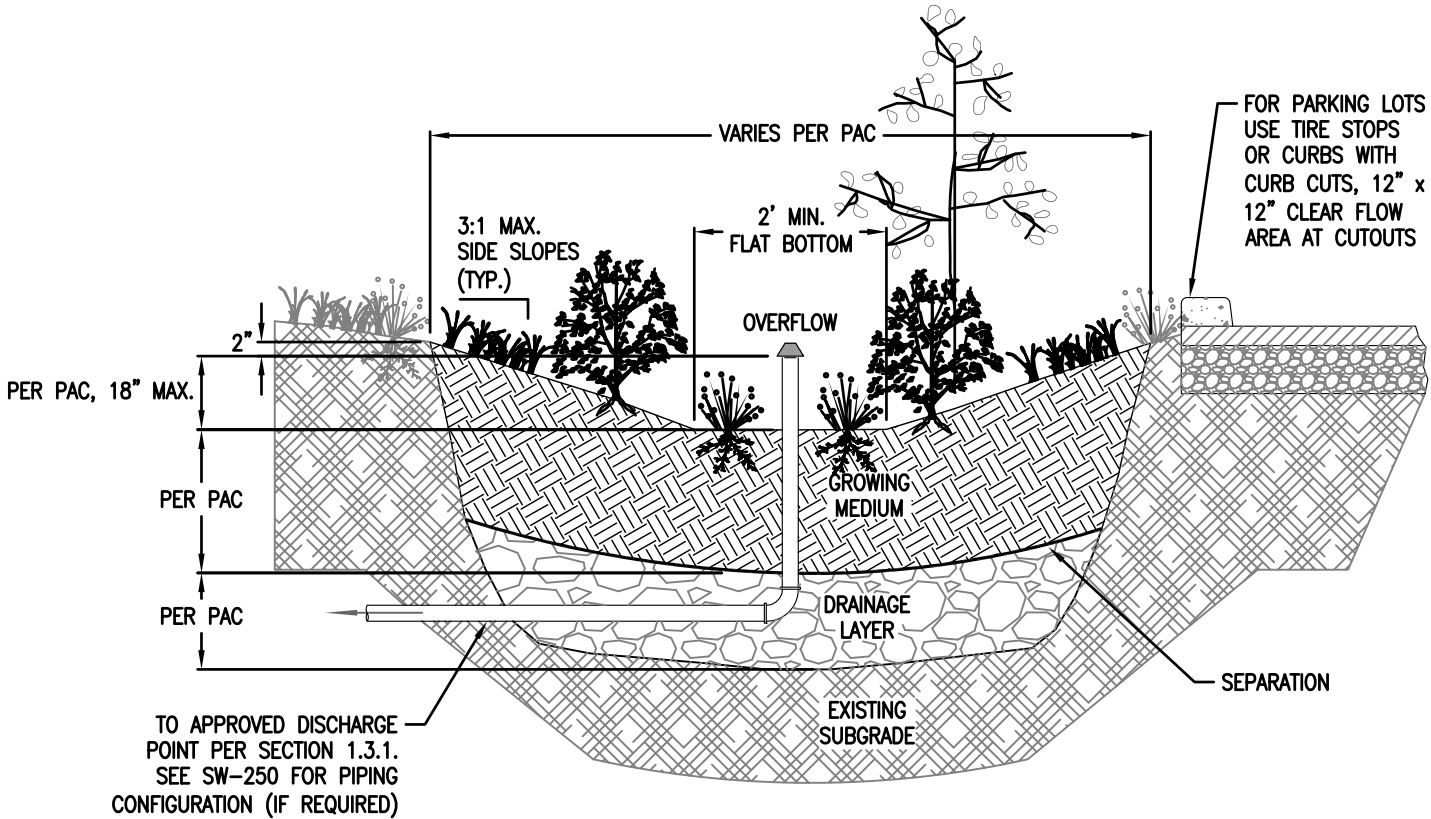

1. Detail intended as an example. Detail must match PAC assumptions and/or design report.
2. Provide protection from all vehicle traffic, equipment staging, and foot traffic in proposed infiltration areas prior to, during, and after construction.
3. Dimensions:
Width of basin: 5' minimum
Depth of basin (from top of growing medium to overflow elevation): Per PAC
Flat bottom width: 2' minimum.
Side slopes of swale: 3:1 maximum.
4. Setbacks:
Basin must be 10' away from foundations and 5' away from property lines.
5. Overflow:
Basins must connect to approved discharge point according to SWMM Section 1.3.
Inlet elevation must allow for 2" of freeboard, minimum.
Protect from debris and sediment with strainer or grate.
6. Piping must be ABS Sch.40, cast iron, or PVS Sch.40. 3" pipe required for facilities draining up to 1500 s.f., otherwise 4" min. pipe. Piping must have 1% grade and follow the Uniform Plumbing Code.
7. Drain Layer: If needed 3/4" - 1 1/2" washed rock or as approved. Depth per PAC.

Separation between drain rock and growing medium: if needed, pea gravel lens, 2 to 3 inches deep or as approved.
8. Growing Medium:
Use sand/loam/compost 3-way mix, or approved mix that will support healthy plants. 18" minimum depth if there is a drainage layer. If soils are well draining and there is not a drainage layer depth may be reduced as approved.
9. Vegetation: Follow landscape plans otherwise refer to plant list in SWMM. Minimum container size is #1. # of plantings per 100sf of facility area:
Zone A (wet): 80 herbaceous plants OR 72 herbaceous plants and 4 small shrubs.
Zone B (moderate to dry): 7 large or small shrubs AND 70 groundcover plants.
The delineation between Zone A and B shall be either at the outlet elevation or the check dam elevation, whichever is lowest.
If project area is over 200sf consider adding a tree.
10. Splash Block: Install 4-6" washed river rock or splash pad for erosion control at inlets and downspout.
11. Inspections: Call BDS IVR Inspection Line, (503) 823-7000, request 487. 3 inspections required.

- DRAWING NOT TO SCALE -

STORMWATER MANAGEMENT TYPICAL DETAILS

- Presumptive and Performance Design Approach -
Basin - unlined



Bureau of Environmental Services



NUMBER

SW-241
7-1-16

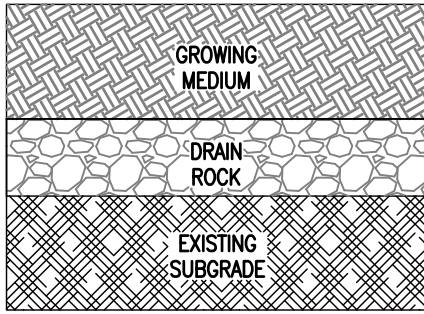

INFILTRATION
 STORMWATER HIERARCHY CATEGORY 1
 PAC CONFIGURATION A, B

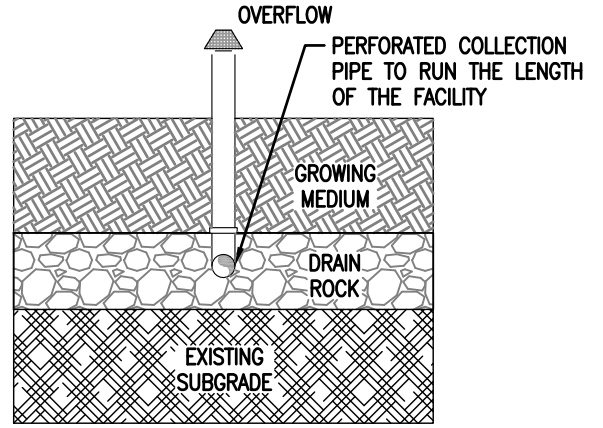

HYBRID
 STORMWATER HIERARCHY CATEGORY 2
 OVERFLOW DIRECTED TO DRAIN ROCK.
 (SEE SW-151 AND SW-152 FOR
 MORE INFORMATION)
 PAC CONFIGURATION E, F

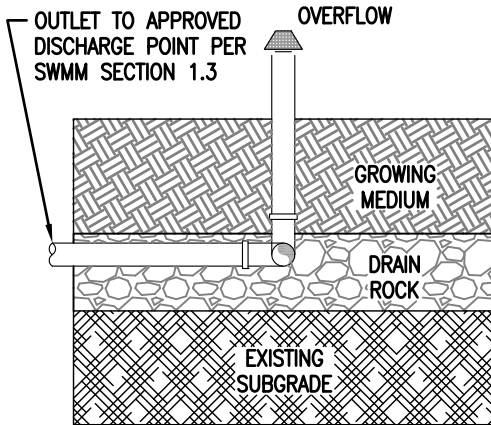

PARTIAL INFILTRATION
 STORMWATER HIERARCHY CATEGORY 3 or 4
 OVERFLOW AND UNDERDRAIN REQUIRED.
 SET UNDERDRAIN WITHIN DRAIN ROCK.
 PAC CONFIGURATION C

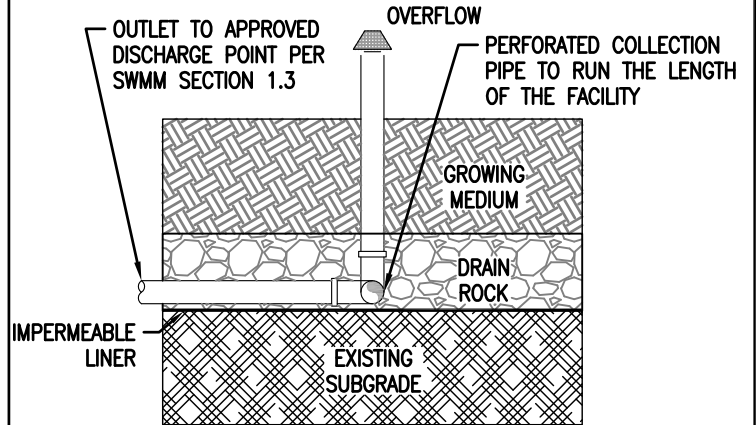

LINED
 STORMWATER HIERARCHY CATEGORY 3 or 4
 OVERFLOW AND UNDERDRAIN REQUIRED.
 SET UNDERDRAIN AT BASE OF DRAIN ROCK LINER.
 PAC CONFIGURATION D

NOTE: Hybrid facilities must be registered as a UIC designed under the presumptive approach.

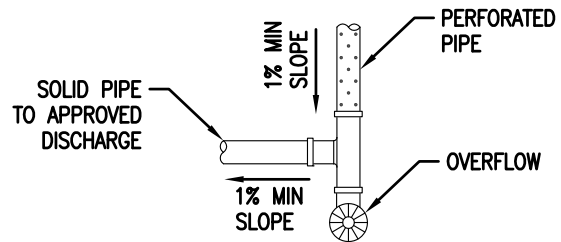

PLAN VIEW
 PIPE W/ UNDERDRAIN & DISCHARGE POINT

- DRAWING NOT TO SCALE -

STORMWATER MANAGEMENT TYPICAL DETAILS

- Presumptive Design Approach -
 Facility Overflow Configurations



Bureau of Environmental Services



NUMBER
 SW-250
 7-1-16

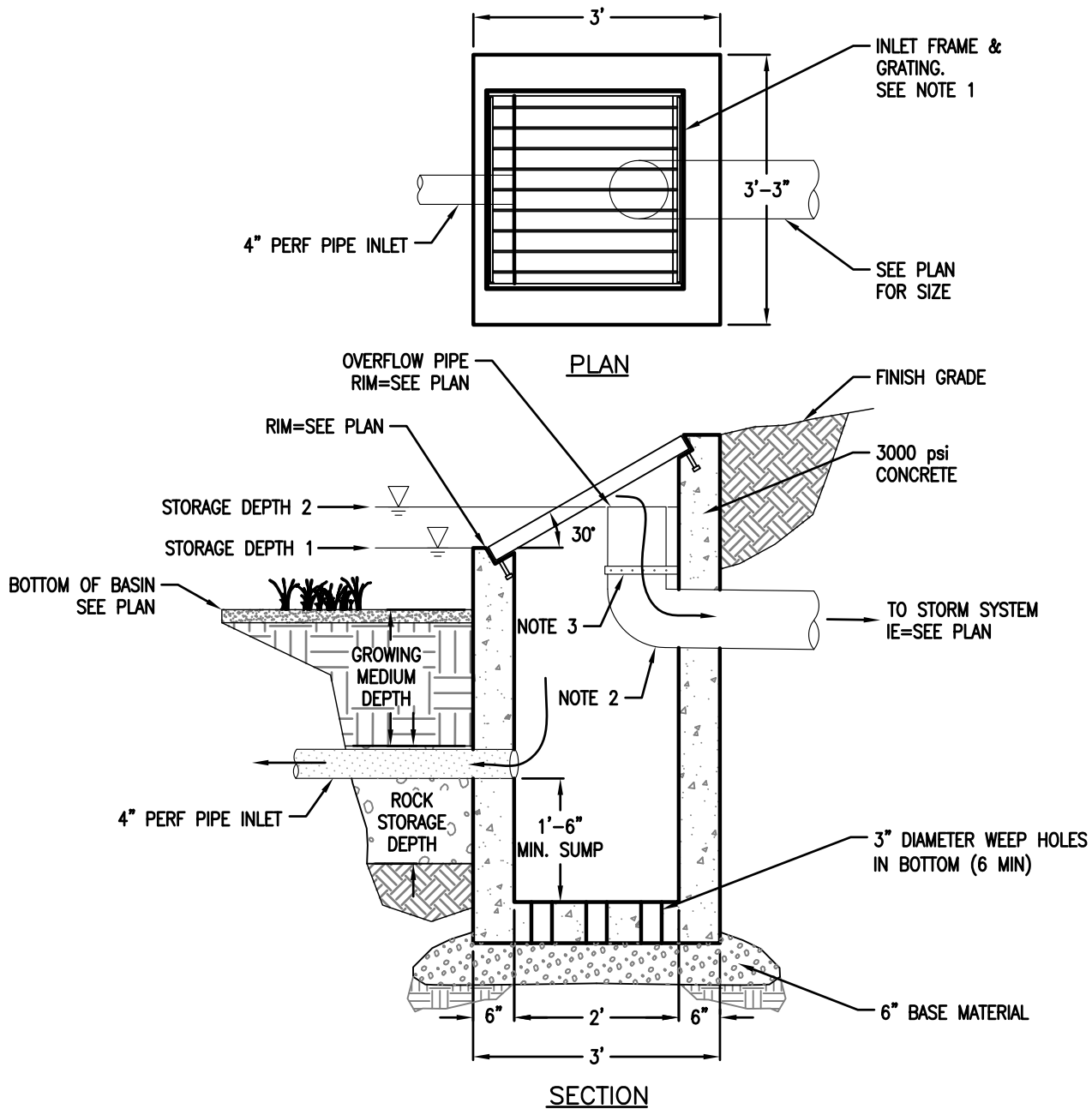

1. Grating and frame must be galvanized steel medium duty.
2. 8" dia. outlet pipe with upturned elbow.
3. Secure outlet pipe with s/s band embedded 2" in wall.

- DRAWING NOT TO SCALE -

STORMWATER MANAGEMENT TYPICAL DETAILS

- Presumptive Design Approach -
 Facility Overflow Configuration E

NUMBER

SW-251
 7-1-16



Bureau of Environmental Services



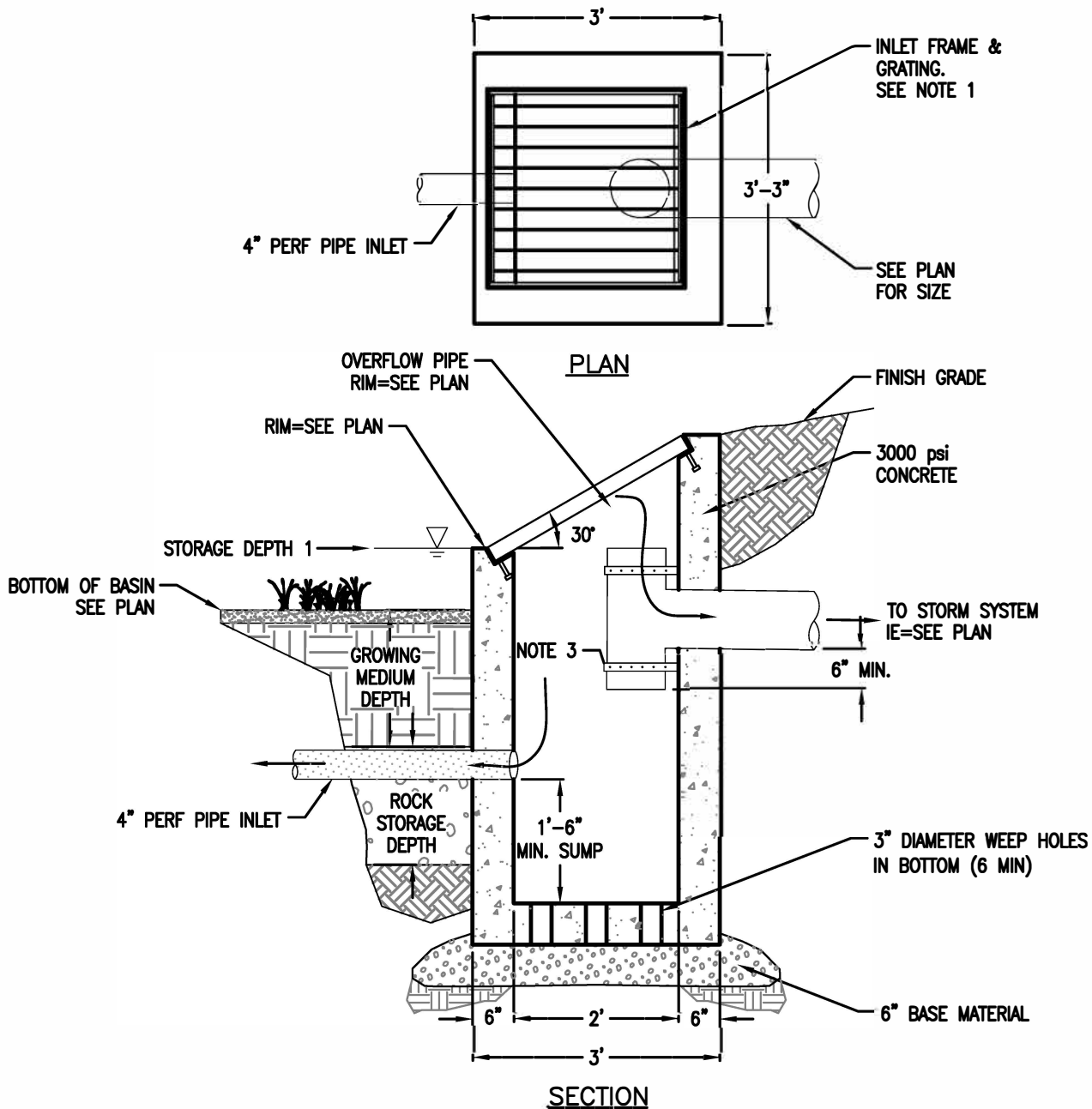

1. Grating and frame must be galvanized steel medium duty.
2. 8" dia. outlet pipe with upturned elbow.
3. Secure outlet pipe with s/s band embedded 2" in wall.

- DRAWING NOT TO SCALE -

STORMWATER MANAGEMENT TYPICAL DETAILS

- Presumptive Design Approach -

Facility Overflow Configuration F

NUMBER

SW-252
7-1-16



Bureau of Environmental Services



DETAIL INTENDED AS AN EXAMPLE. DETAIL MUST MATCH PAC ASSUMPTIONS AND/OR DESIGN REPORT.

FLOW SPREADER IS REQUIRED TO EVENLY DISTRIBUTE WATER IF SURFACE IS UNEVEN.

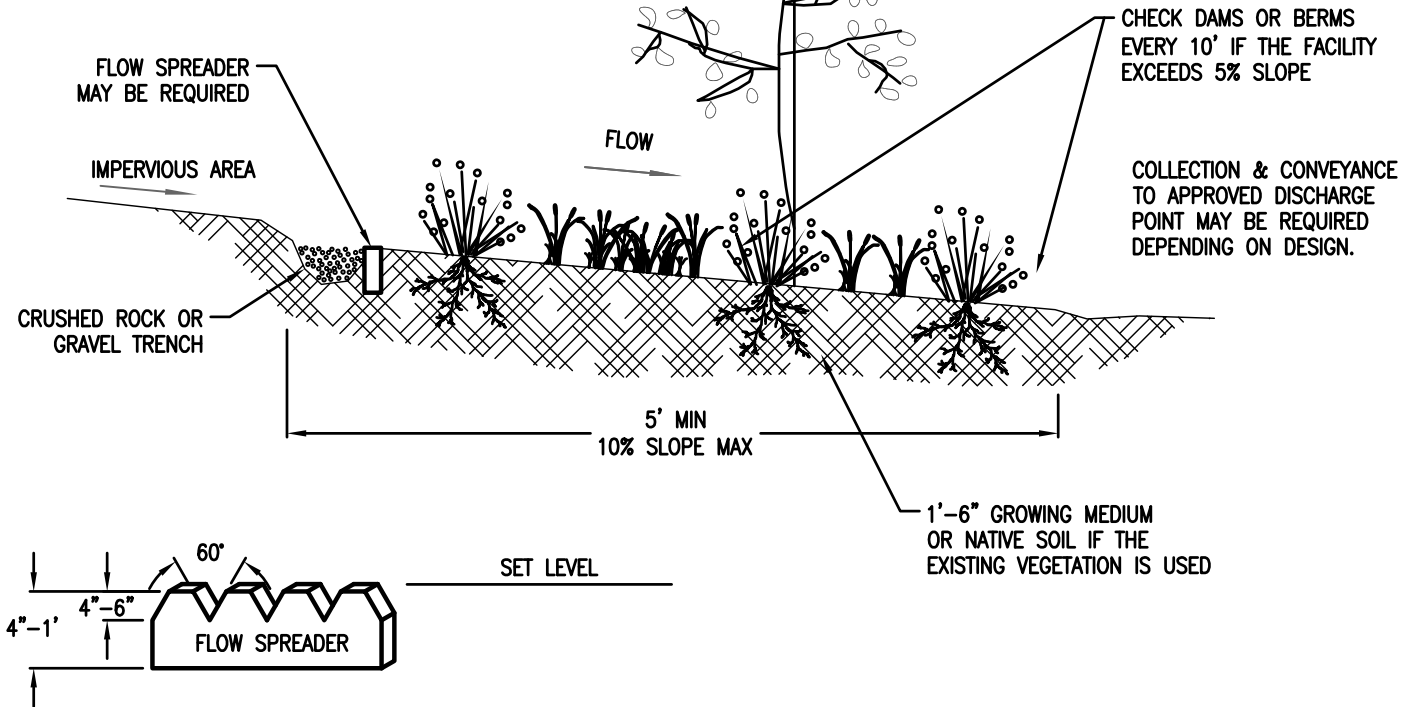

1. Detail intended as an example. Detail must match PAC assumptions and/or design report.
2. Provide protection from all vehicle traffic, equipment staging, as well as foot traffic for proposed infiltration areas prior to and during construction.
3. Dimensions:
 - a. Flow line length: 5' minimum.
 - b. Slopes: 0.5 - 10%
4. Setbacks (from beginning of facility):
 - a. 5' from property line
 - b. 10ft from buildings
 - c. 50ft from wetlands, rivers, streams, and creeks where required.
5. Overflow: Collection from filter strip must be specified on plans to approved discharge point according to SWMM Section 1.3.
6. Growing Medium: Unless existing vegetated areas are used for the filter strip, growing medium must be used within the top 18" (Or approved mix. Use sand/loam/compost 3-way mix).
7. Vegetation: The entire filter strip must have 100% coverage by native grasses, native wildflower blends, native ground covers, or any combination thereof.
8. Flow Spreaders: A grade board or sand/gravel trench may be required to disperse the runoff evenly across the filter strip to prevent a point of discharge. The top of the level spreader must be horizontal and at an appropriate height to provide sheetflow directly to the soil without scour. Level spreaders must not hold a permanent volume of runoff. Grade boards can be made of any material that will withstand weather and solar degradation. Trenches used as level spreaders can be filled with washed crushed rock, pea gravel, or sand
9. Check Dams: must be placed according to facility design otherwise:
 - a. Equal to the width of the filter
 - b. 3 to 5" in height
 - c. Every 10' where slope exceeds 5%.
9. Inspections: call BDS IVR Inspection Line, (503) 823-7000, for appropriate inspections.

- DRAWING NOT TO SCALE -

STORMWATER MANAGEMENT TYPICAL DETAILS

- Performance Design Approach -
Filter Strip



Bureau of Environmental Services



NUMBER

SW-260
7-1-16

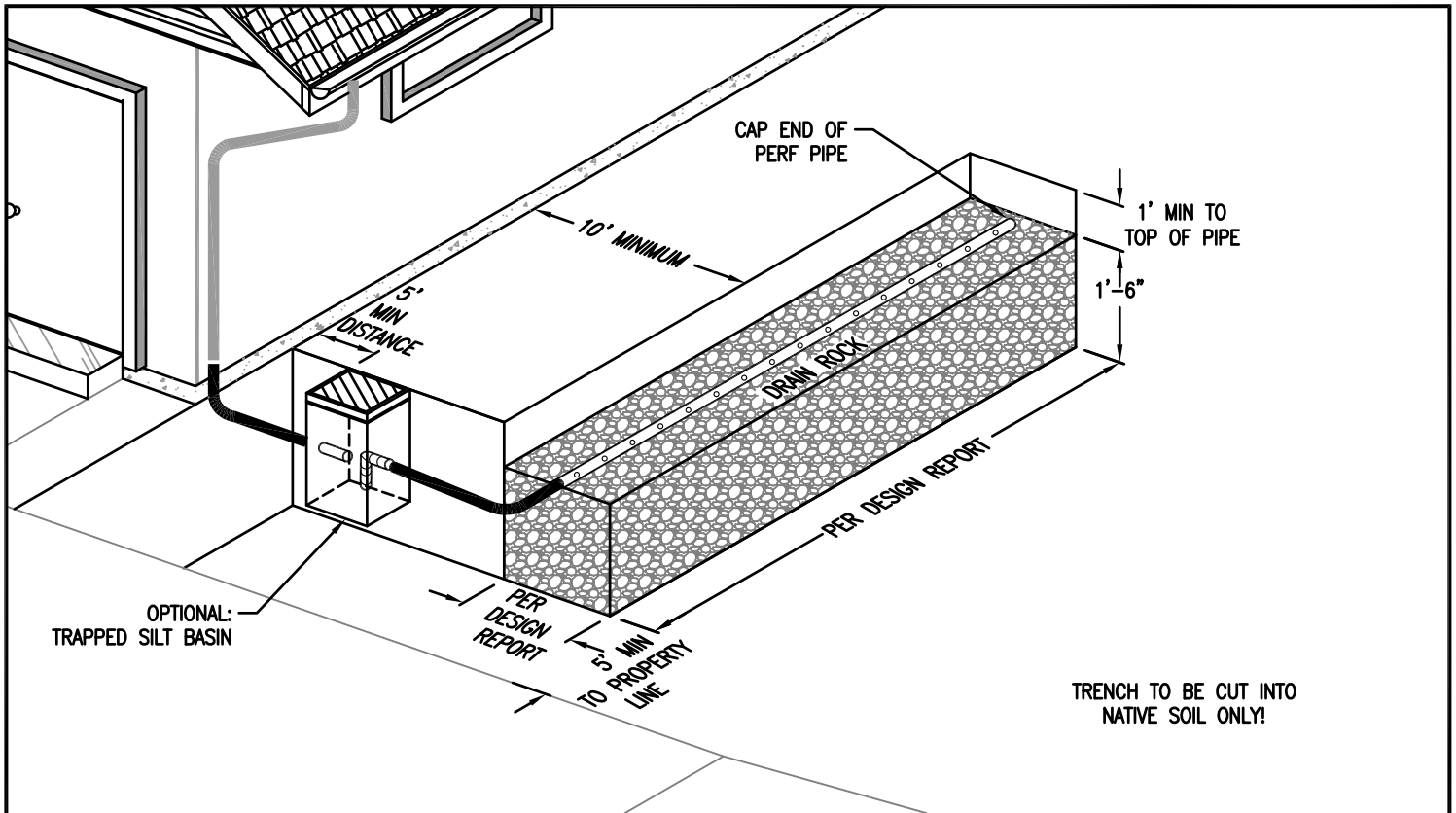

SOAKAGE TRENCH CONSTRUCTION—SECTION

FILTER FABRIC TO BE PLACED ON SIDES AND ENDS. TO FOLD OVER AND COVER PERF PIPE AND DRAIN ROCK.

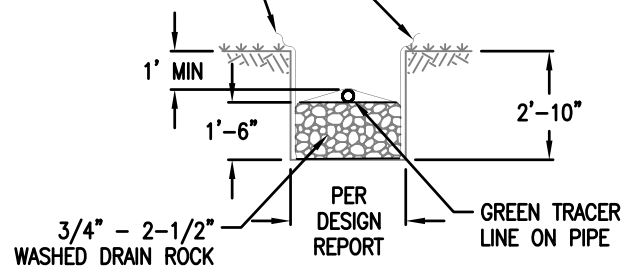

LINE TRENCH SIDES WITH FILTER FABRIC AS SHOWN, ADD 18" OF DRAIN ROCK. PLACE PERF. PIPE AND COVER ALL.

1. Detail intended as an example. Detail must match design report.
2. Provide protection from all vehicle traffic, equipment staging, and foot traffic in proposed infiltration areas prior to, during and after construction.
3. Siting Criteria: Soakage trench must not be placed where base of facility has less than 5' of separation to water table.
4. Sizing: Per design report.
5. Setbacks: Soakage trench measured from outside edge of facility, must be 10' from foundations, 5' from property lines, and 20' from cesspools.
6. Piping: must be ABS Sch.40, cast iron, or PVC Sch.40. 3" pipe required for up to 1,500 sq ft of impervious area, otherwise 4" min. Piping must have 1% grade and follow the Uniform Plumbing Code.
7. Trapped Silt Basin: Optional for roof runoff or pedestrian-only paved areas.

- DRAWING NOT TO SCALE -

STORMWATER MANAGEMENT TYPICAL DETAILS

- Performance Design Approach -
Soakage Trench



Bureau of Environmental Services



NUMBER

SW-270

7-1-16

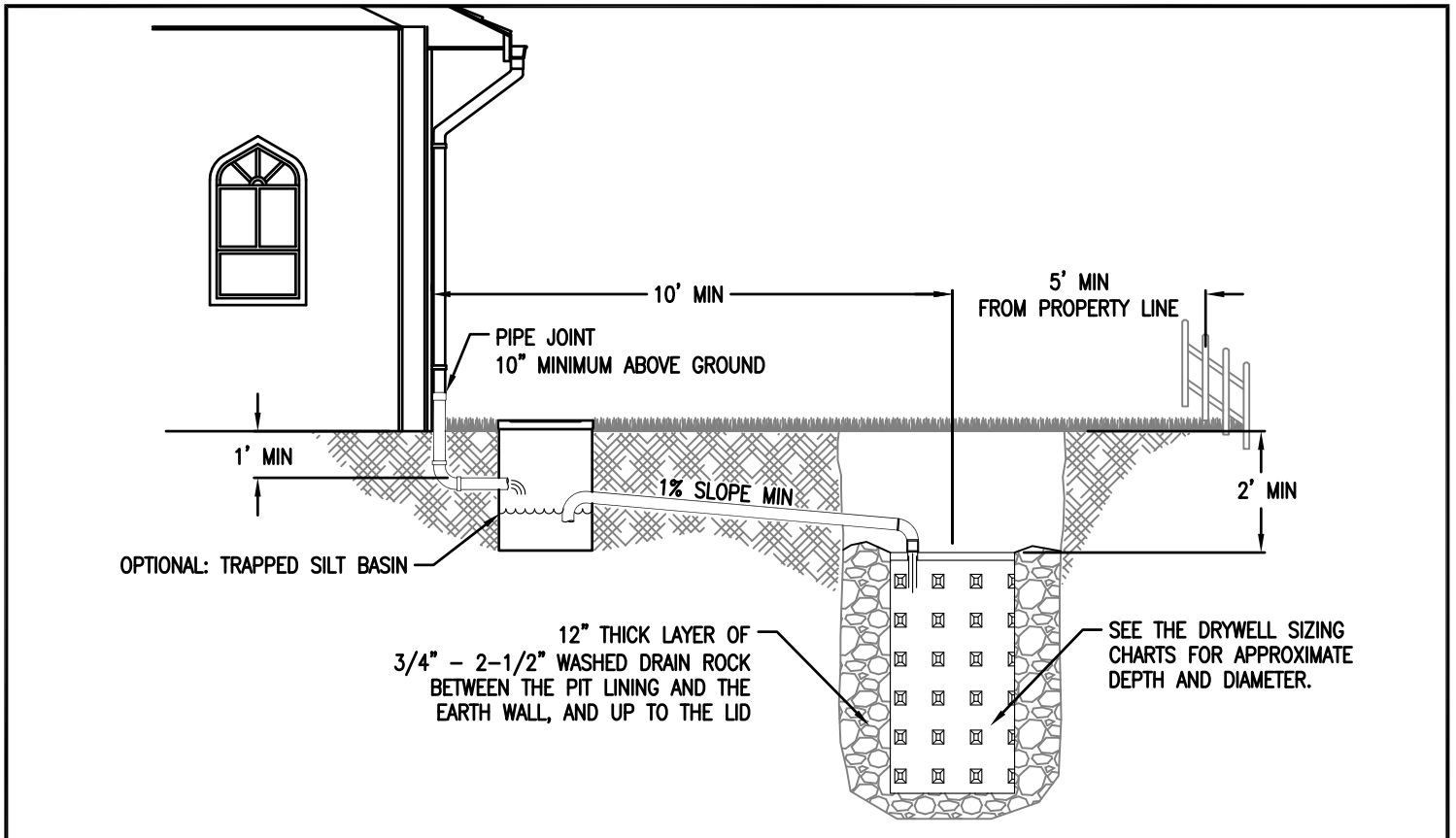

1. Detail intended as an example. Detail must match design report.
2. Provide protection from all vehicle traffic, equipment staging, and foot traffic in proposed infiltration areas prior to, during and after construction.
3. Siting Criteria: Gravelly sand, gravelly loamy sand or other equally porous material must occur in a continuous 5' deep stratum within 12' of the ground surface. Drywell must not be placed where base of facility has less than 5' of separation to water table.
4. Sizing: Exhibit 2-36 is used as guidance to size drywells. Sizing per stormwater report.
5. Top of drywell must be below lowest finished floor.
6. Setbacks: Measured from center of drywell, must be 10' from foundations, 5' from property lines, and 20' from cesspools. Drywells sized using the performance approach that use a significantly sized rock gallery must measure setbacks from the edge of the rock gallery or get approval from geotechnical and structural engineers to place drywell closer to the foundation.
7. Piping: must be ABS Sch.40, cast iron, or PVC Sch.40. 3" pipe required for up to 1,500 sq ft of impervious area, otherwise 4" min. Piping must have 1% grade and follow the Uniform Plumbing Code.

8. Trapped Silt Basin: Optional for roof runoff or pedestrian only paved areas.

Exhibit 2-36: Drywell Sizing Table

Once approval has been given by BES for onsite infiltration of stormwater, the following chart shall be used as a general guide for sizing. Sizing per stormwater report.

IMPERVIOUS Area (sq-ft)	28" Diameter Drywell Depth				48" Diameter Drywell Depth			
	5'	10'	15'	20'	5'	10'	15'	20'
	1000							
2000								
3000								
4000								
5000								
6000								
7000								
8000								
9000								
10000								

- DRAWING NOT TO SCALE -

STORMWATER MANAGEMENT TYPICAL DETAILS

- Performance Design Approach -
Drywell



Bureau of Environmental Services



NUMBER
SW-280
7-1-16

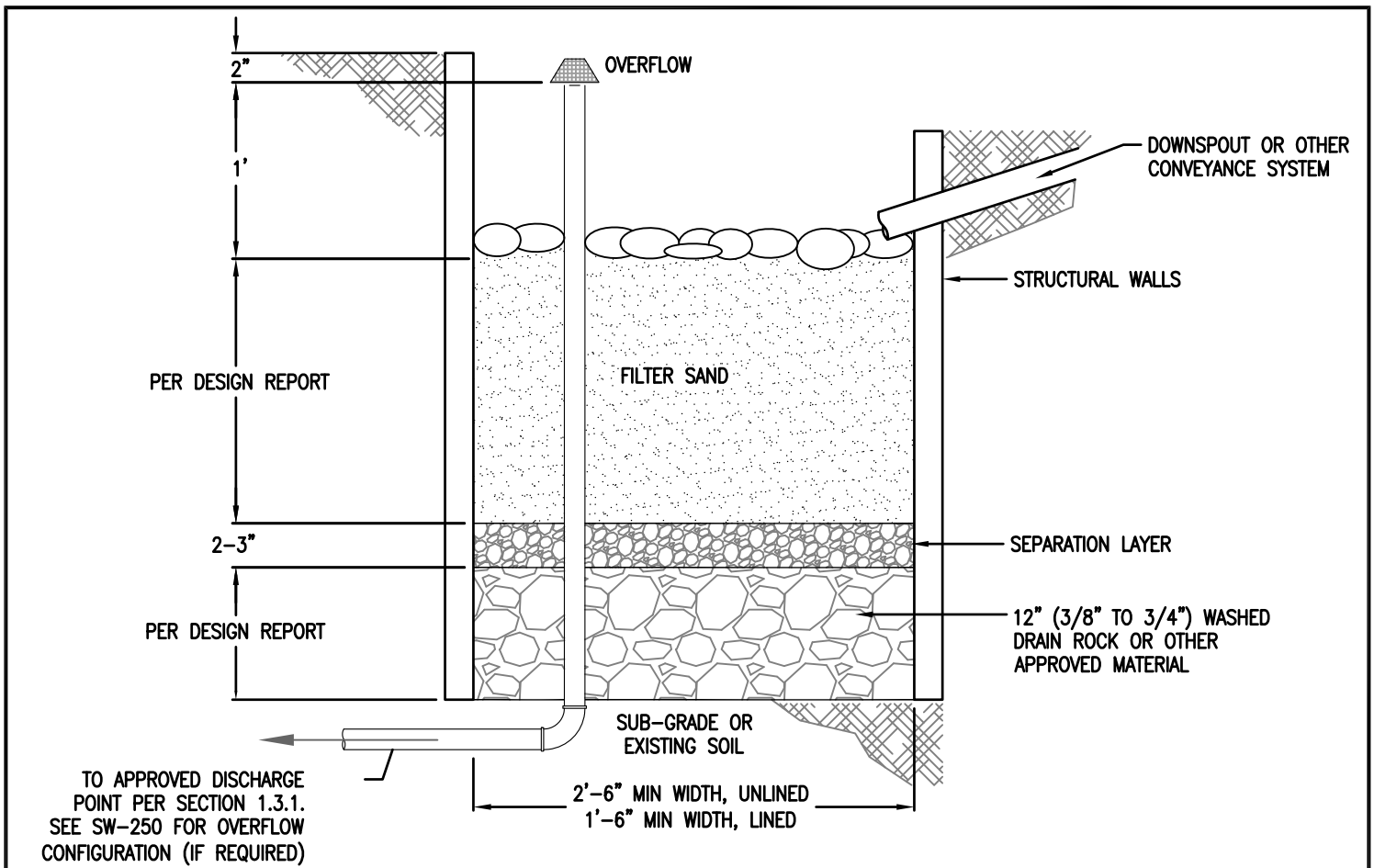

1. Provide protection from all vehicle traffic, equipment staging, and foot traffic in proposed infiltration areas prior to, during, and after construction.
2. Dimensions:
 - a. Width of sand filter: 2'-6" minimum, unlined. 1'-6" minimum lined.
 - b. Depth of sand filter (from top of sand to overflow elevation). Simplified: 12"; Presumptive: 6"- 18".
 - c. Slope of sand filter: 0.5% or less.
3. Setbacks (from edge of facility):
 - a. Infiltration sand filters must be 10' from foundations and 5' from property lines.
 - b. Walls must be less than 30" in height above surrounding area if within 5 feet of property line.
4. Overflow (where required):
 - a. Inlet elevation must allow for 2" of freeboard, minimum.
 - b. Protect from debris, sand, and sediment with strainer or grate.
5. Piping: must be ABS Sch.40, cast iron, or PVC Sch.40. 3" pipe required for up to 1,500 sq ft of impervious area, otherwise 4" min. Piping must have 1% grade and follow the Uniform Plumbing Code.
6. Drain Rock (minimum):
 - a. Infiltration sand filter: 12" of 1-1/2" - 3/4" washed.
 - b. Flow-through sand filter: 8" of 3/4" washed.
7. Separation between drain rock and sand: Use a gravel lens (3/4 - 1/4 inch washed, crushed rock 2 to 3 inches deep) or approved equivalent.
8. Filter Sand:
 - a. 18" minimum.
 - b. See sand spec in SWMM chapter 2
9. Sand Filter Walls:
 - a. Material must be concrete unless otherwise approved.
 - b. Walls must be included on foundation plans.
10. Waterproofing: If walls are monolithically poured no additional liner/waterproofing is required. Check state structural requirements for foundations.
11. Install washed pea gravel or river rock to transition from inlet or splash pad to sand.
12. Inspections: Call BDS IVR Inspection Line, (503) 823-7000, for appropriate inspections.

- DRAWING NOT TO SCALE -

STORMWATER MANAGEMENT TYPICAL DETAILS

- Performance Design Approach -
Sand Filter



Bureau of Environmental Services



NUMBER

SW-290
7-1-16

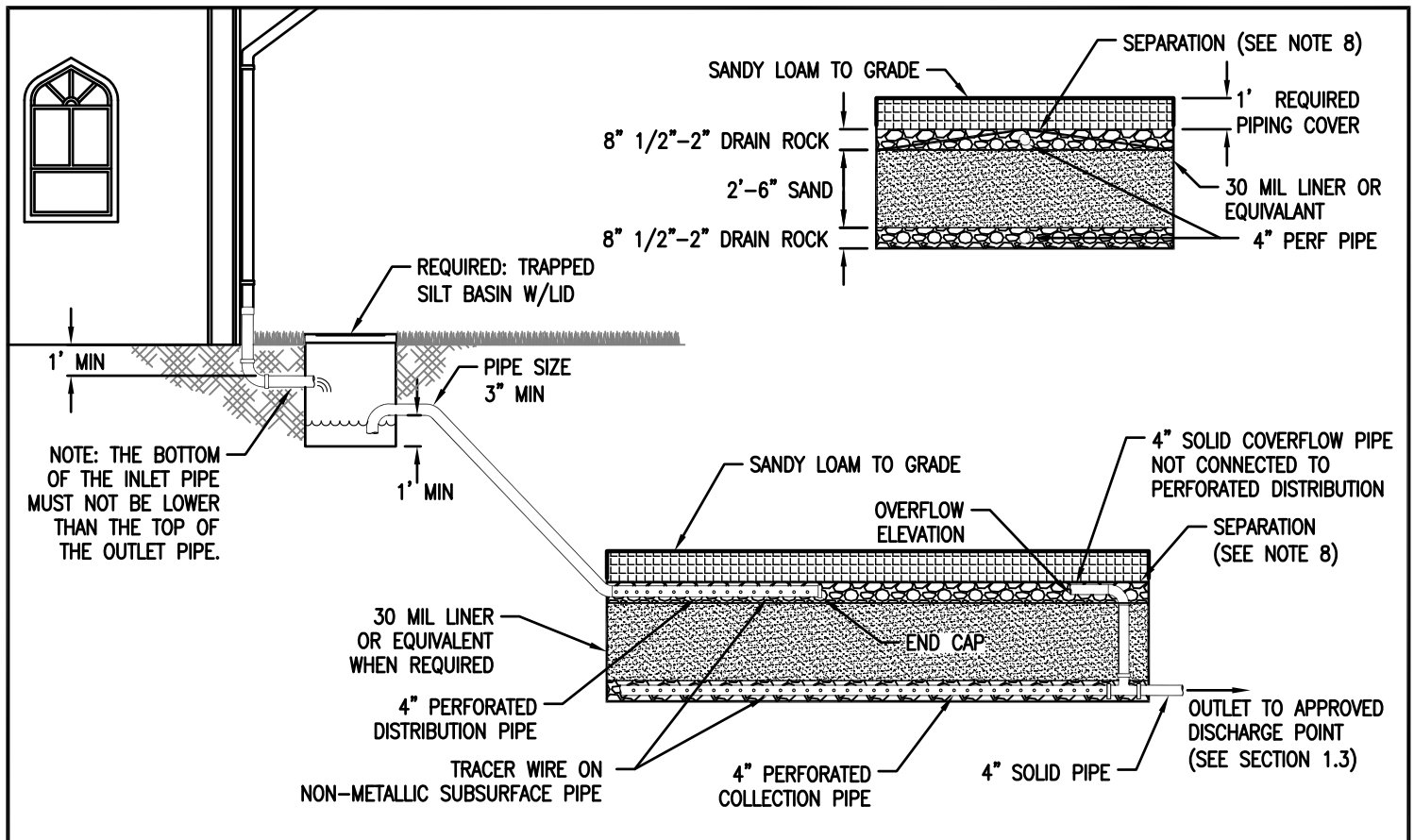

1. Provide protection from all vehicle traffic, equipment staging, and foot traffic in proposed infiltration areas prior to and during construction.
2. Dimensions:
 - a. Height of subsurface sandfilter: 46" from base.
 - b. Depth of excavation: 58" Min. (to accommodate 12" of cover).
3. Setbacks (from edge of facility):
 - a. Infiltration facilities must be 10' from foundations and 5' from property lines.
 - b. Lined facilities may be within 10' of foundation and within 5' of property line if properly lined.
4. Trapped silt basin required prior to inlet to subsurface sand filter.
5. Overflow: perforated collection pipe within top gravel layer connected to approved discharge point according to Section 1.3.
6. Piping must be ABS Sch40, cast iron, or PVC Sch40. 3" pipe must be used for up to 1500sf of impervious area, otherwise 4" minimum. Piping must have 1% grade and must follow current Uniform Plumbing Code.
 - a. Underdrain piping system must consist of minimum 4" diameter collector manifold with perforated lateral branch lines.
 - b. Underdrain laterals must be placed with minimum 1% positive gravity drainage to the collector manifold.
 - c. The collector manifold must have a minimum 1% grade toward the discharge joint.
 - d. Lateral spacing of collection or distribution pipes must not exceed 10'.
 - e. All laterals and collector manifolds must have cleanouts installed, accessible from the surface without removing or disturbing filter media.
 - f. Outlet to approved discharge point must be protected from soil, gravel, or sand displacement with filter fabric or equivalent.
7. Drain Rock and Sand Depth:
 - a. 8" of 3/4" washed drain rock as base.
 - b. 30" of washed sand per chapter 2.
 - c. 8" top layer of 3/4" washed drain rock over sand.
8. Separation between drain rock and sand: Use filter fabric or a gravel lens (3/4 - 1/4 inch washed, crushed rock 2 to 3 inches deep) or approved equivalent.
9. Waterproof Liner: Must be 30 mil EPDM, HDPE or equivalent for facilities when lining is required.
10. Inspections: Call BDS IVR Inspection Line, (503) 823-7000, for appropriate inspections.

- DRAWING NOT TO SCALE -

STORMWATER MANAGEMENT TYPICAL DETAILS

- Performance Design Approach -
Subsurface Sand Filter

NUMBER

SW-291
7-1-16



Bureau of Environmental Services



2.3.5 Green Street Typical Details

Table of Contents

SWALES

- SW-300 - Plan View
- SW-301 - Section View
- SW-302 - (Removed)
- SW-303 - Landscape Planting Templates
- SW-304 - Meter & Hydrant Locations

PLANTERS

- SW-310 - Plan View without Parking
- SW-311A - Plan View with Parking (2.5' Step-out)
- SW-311B - Plan View with Parking (1' Step-out)
- SW-312A - Section Views
- SW-312B - Section View (2.5' Step-out)
- SW-313 - Planter Wall Details
- SW-314 - (Removed)
- SW-315 - Landscape Planting Templates
- SW-316A - Meter & Hydrant Locations
- SW-316B - Meter & Hydrant Locations

CURB EXTENSIONS

- SW-320 - In-Street Plan View
- SW-321 - In-Planting-Strip Plan View
- SW-322 - Section Views
- SW-323 - Landscape Planting Templates
- SW-324 - Meter & Hydrant Locations

CURB INLETS

- SW-330 - Concrete Inlet with Wingwalls
- SW-331 - Concrete Inlet
- SW-332 - Metal Inlet
- SW-333 - Inlet & Outlet for Curb Extensions
- SW-334 - Modified Metal Inlet Assembly
- SW-335A - Channel & Grate Details
- SW-335B - Inlet, Channel & Grate Details (Step-Out)
- SW-336 - Grate & Frame Details

CHECK DAMS

- SW-340 - (Removed)
- SW-341 - Wooden Check Dam for Swales
- SW-342 - Wooden Check Dam for Planters
- SW-343 - Concrete Check Dam for Planters

OVErM RFLOW INLETS

- SW-350 - Beehive Inlet Grate
- SW-351 - Overflow Drain

ADDITIONAL DETAILS

- SW-360 - Liner Attachment & Pipe Boot Details
- SW-361 - Tree Well Detail Without Rock Storage
- SW-362 - Tree Well Detail With Rock Storage
- SW-363 - Herbaceous Plants, Groundcovers & Shrubs
- SW-364 - Facility Overflow Configurations

STORMWATER MANAGEMENT MANUAL TYPICAL DETAILS

- Green Streets - Table of Contents



Bureau of Environmental Services



NUMBER

TOC

7-1-2016

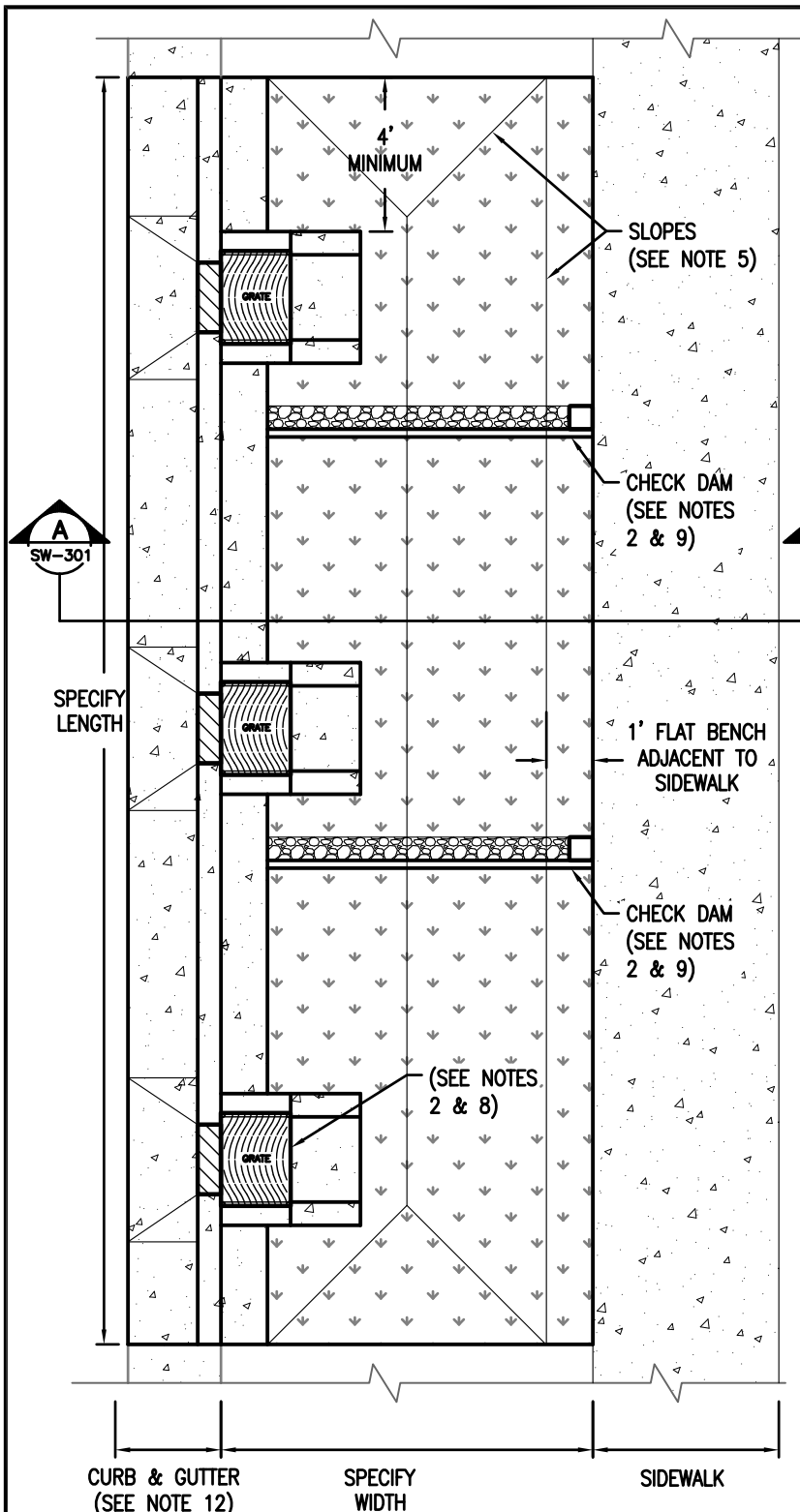

PLAN VIEW

(Swale with Parking shown here)

- DRAWING NOT TO SCALE -

DESIGNER INFORMATION:

1. Adapt this plan view example to your engineered design. Maximize surface storage.
2. Provide beginning and ending stations for each facility. Provide stationing and/or dimensions and elevations at each inlet, outlet and check dam.
3. Sidewalk elevation must be set above check dam and inlet elevations to allow overflow to drain to street before sidewalk.
4. Proposed utility lines to be located out of facility.
5. Slopes 3:1. See swale sections on SW-301, unless otherwise specified.
6. Longitudinal slope of swale matches the road.
7. Area and Depth of facility are based upon engineering calculations and right-of-way constraints. See chapter 2 of the City of Portland Stormwater Management Manual (SWMM).

RELATED DETAILS AND RESOURCES:

8. Inlet and Grate details SW-332, SW-335B and SW-336.
9. Check Dam details SW-341 and SW-342.
10. Special requirements for water lines, meters, and fire hydrants. (see SW-304)
11. Swale Planting Template. (see SW-303)
12. Curb and Gutter per PBOT standard drawing P-540.
13. Stormwater facility construction and blended soil requirements see City of Portland Standard Construction Specifications, sections 00415 and 01040.14(d).

IMPORTANT: Utility conflicts and existing conditions can create major design variables. Locate utilities and survey existing conditions prior to beginning design work and include information on design drawings.

The Portland Bureau of Transportation (PBOT), Portland Water Bureau (PWB), and Bureau of Environmental Services (BES) are responsible for the review and approval of Stormwater Swales in the public right of way. Stormwater facilities in Wellhead Protection Areas may require special containment measures as required by City Code 21.35.

For more information contact:

PBOT (503) 823-7884 BES (503) 823-7761
 PWB (503) 823-7368 Urban Forestry (503) 823-4489

STORMWATER MANAGEMENT MANUAL TYPICAL DETAILS

- Green Streets -
 Plan View
 Swale



Bureau of Environmental Services



NUMBER

SW-300

7-1-2016

- PARKING -

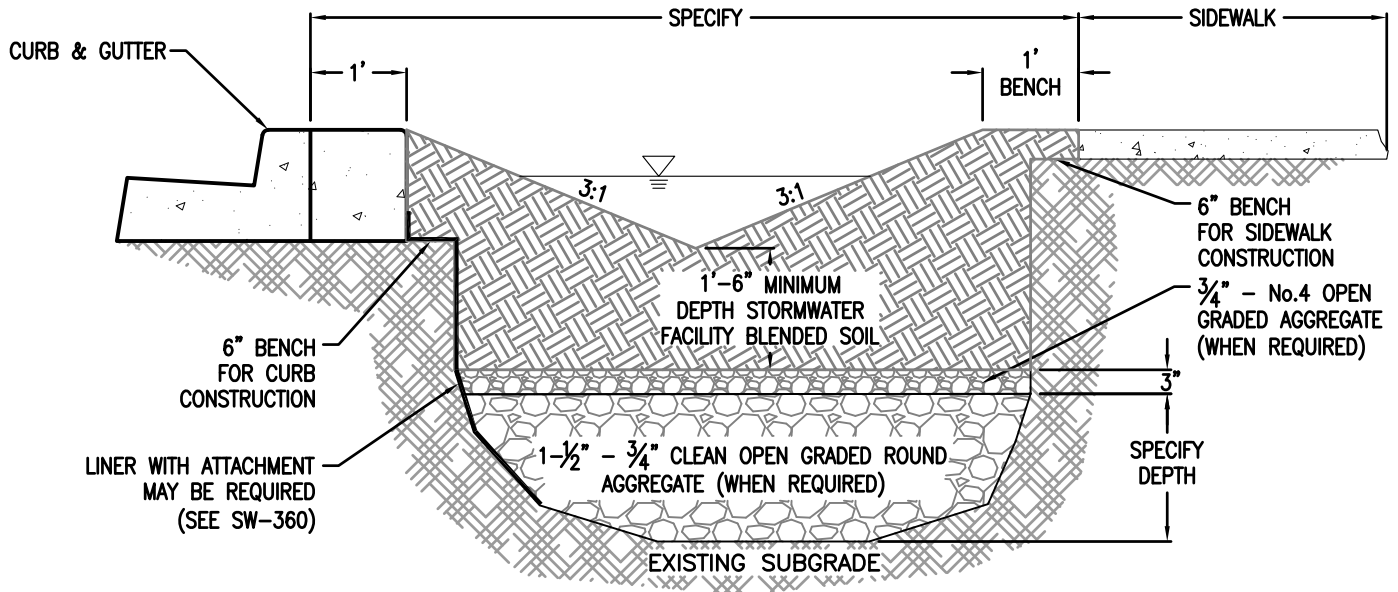

SECTION A-A
SWALE

DESIGNER INFORMATION:

1. Show liner and perf-pipe in the Section view if they are required
2. Typical facility width is 8' from back of curb to sidewalk

CONSTRUCTION NOTE:

In facilities that are unlined, fracture and loosen soil to a depth of 12" below grade before installing blended soil or aggregate. Do not till.

- DRAWING NOT TO SCALE -

FOR PLAN VIEW
SEE SW-300

STORMWATER MANAGEMENT MANUAL TYPICAL DETAILS



Bureau of Environmental Services

- Green Streets -
Section View
Swale



NUMBER

SW-301

7-1-2016

TEMPLATE 1

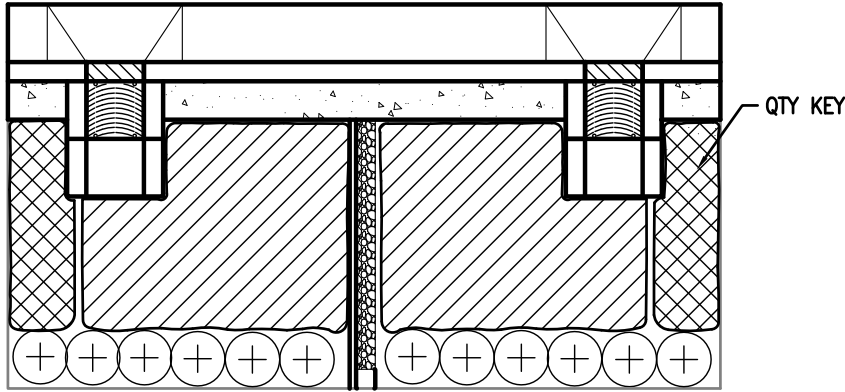

Key	Recommended Plants
ZONE A	
	<i>Carex obnupta</i> Slough Sedge <i>Juncus patens</i> Spreading rush
ZONE B	
	<i>Mahonia repens</i> Creeping oregon grape <i>Spiraea x bumalda 'Goldflame'</i> Goldflame spiraea
	<i>Rubus calycinoides</i> Creeping raspberry

TEMPLATE 2

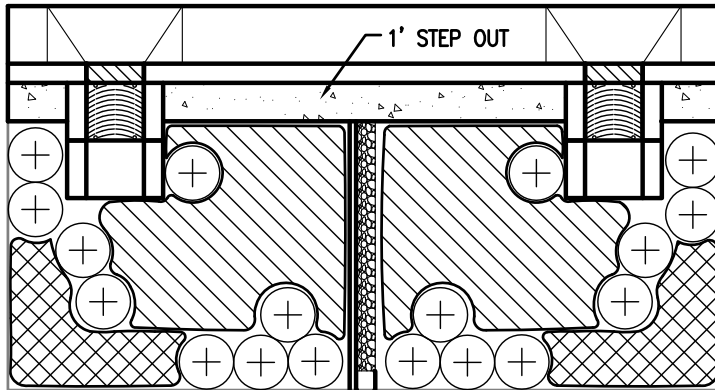

Key	Recommended Plants
ZONE A	
	<i>Carex obnupta</i> Slough Sedge <i>Juncus patens</i> Spreading rush
ZONE B	
	<i>Cornus sericea 'Kelsey'</i> Dwarf Red-Twig Dogwood <i>Spiraea x bumalda 'Goldmound'</i> Goldmound spiraea
	<i>Fragaria chiloensis</i> Coastal Strawberry

SAMPLE PLANT LEGEND

SYMBOL	BOTANIC NAME	COMMON NAME	SIZE	SQ. FOOT AREA		
				SPACING	QTY. ZONE A	QTY. ZONE B
	Xxxxx xxxxx	xxxxx	X	X	X	X
	Xxxxx xxxxx	xxxxx	X	X	X	X

INSTRUCTIONS

1. Choose a template and alter it to design. These are examples of approved planting templates. Other planting plans may be approved.
2. Plant lists and on-center spacing requirements are found in Section 2.4.1 of the City of Portland Stormwater Management Manual.
3. Planting legend required. State plant species, spacing, and quantities per Zone A and Zone B and per facility. Include the square footage of Zone A and B.
4. Planting Plans shall include labels for each plant group identifying the plant species and quantity in the group.
5. See detail SW-363 for plant spacing.

- DRAWING NOT TO SCALE -

STORMWATER MANAGEMENT MANUAL TYPICAL DETAILS



Bureau of Environmental Services

- Green Streets -
Landscape Planting Templates
Swales



NUMBER

SW-303

7-1-2016

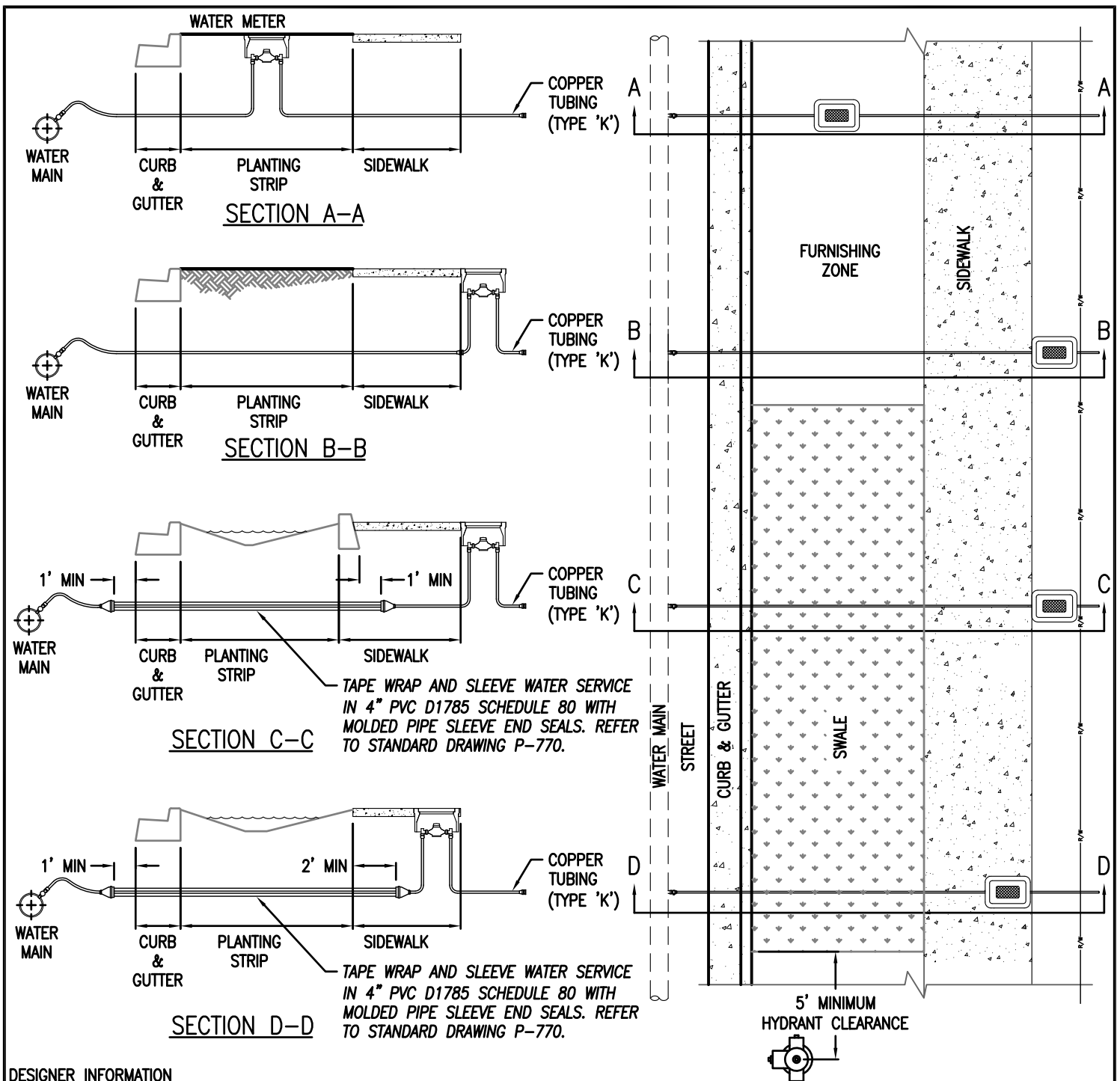

DESIGNER INFORMATION

1. Refer to Fire Hydrant Assembly Standard Drawing P-700. Center of hydrants must have min 5 ft clearance to the outside edge of stormwater facility.
2. Standard meter location is Option A. Option B or C can be used only if a minimum of 3' is available between back of sidewalk and the Right-of-Way line. Option D can only be used for an existing service when other options are infeasible, where a minimum of 1' is available between the back of sidewalk and the Right-of-Way line, and it requires a Design Exception from PBOT, to be obtained by the project owner.
3. Refer to 1" Service Assembly Standard Drawing P-780. For larger services or other appurtenances, contact PWB development services at (503) 823-7368. Water service line must be 2 ft min. from bottom of stormwater facility blended soil.
4. Maintain 2 ft skin-to-skin separation distance between the face of gutter pan and the water main. If water main is < 2 ft from face of gutter pan, the water main must be relocated unless otherwise approved by PWB. Verification of water main depth is required prior to PWB approval.
5. Cross-section views are not required on construction plans.

- DRAWING NOT TO SCALE -

STORMWATER MANAGEMENT MANUAL TYPICAL DETAILS



Bureau of Environmental Services

- Green Streets -
Meter & Hydrant Locations
Swales



NUMBER

SW-304

7-1-2016

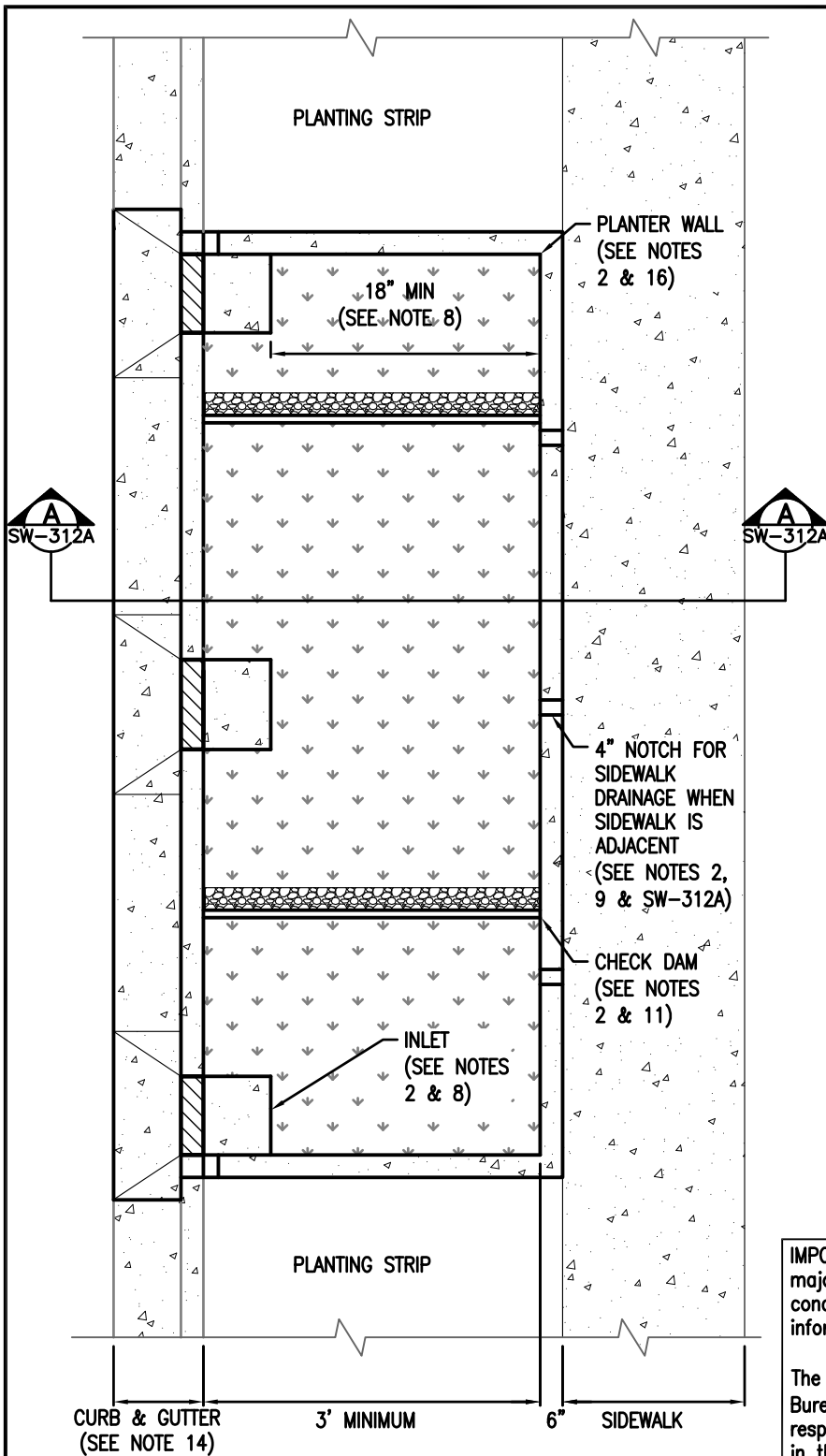

PLAN VIEW

- DRAWING NOT TO SCALE -

DESIGNER INFORMATION:

1. Adapt this plan view example to your engineered design. Maximize surface storage.
2. Provide beginning and ending stations for each facility. Provide stationing and/or dimensions and elevations at each inlet, outlet, check dam, planter corner and sidewalk notches.
3. Sidewalk elevation must be set above check dam and inlet elevations to allow overflow to drain to street before sidewalk.
4. Proposed utility lines to be located out of facility.
5. Longitudinal slope of planter matches the road, unless otherwise specified.
6. Area and Depth of facility are based upon engineering calculations and right-of-way constraints. See Chapter 2 of the City of Portland Stormwater Management Manual (SWMM).
7. Minimum interior planter width is 3ft. A minimum of 4 feet is required for planters with street trees.
8. If less than 18" between splash pad and planter wall, extend pad to wall.
9. Place one notch at low point of sidewalk. Space additional notches approximately 6ft apart.

RELATED DETAILS AND RESOURCES:

10. Inlet details SW-331 and SW-332
11. Check Dam details SW-342 and SW-343
12. Special requirements for water lines, meters, and fire hydrants (see SW-316B)
13. Planter Planting Template (see SW-315)
14. Curb and Gutter per PBOT standard drawing P-540
15. Stormwater facility construction and blended soil requirements see City of Portland Standard Construction Specifications, sections 00415 and 01040.14(d)
16. Planter wall detail (see SW-313)

IMPORTANT: Utility conflicts and existing conditions can create major design variables. Locate utilities and survey existing conditions prior to beginning design work and include information on design drawings.

The Portland Bureau of Transportation (PBOT), Portland Water Bureau (PWB), and Bureau of Environmental Services (BES) are responsible for the review and approval of Stormwater Swales in the public right of way. Stormwater facilities in Wellhead Protection Areas may require special containment measures as required by City Code 21.35.

For more information contact:

PBOT (503) 823-7884 BES (503) 823-7761
PWB (503) 823-7368 Urban Forestry (503) 823-4489

STORMWATER MANAGEMENT MANUAL TYPICAL DETAILS



Bureau of Environmental Services

- Green Streets -
Plan View without Parking
Planters



NUMBER

SW-310

7-1-2016

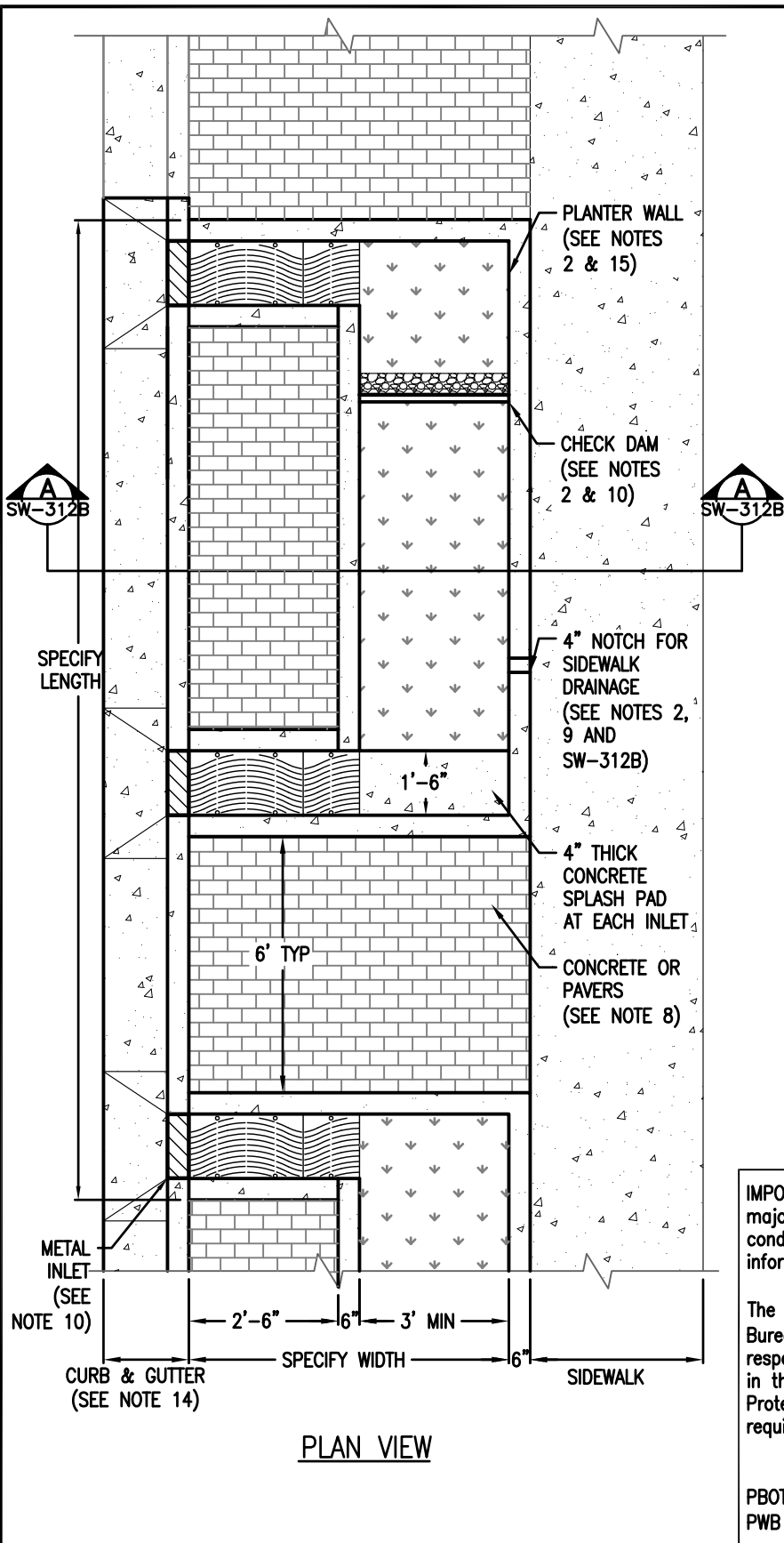

DESIGNER INFORMATION:

1. Adapt this plan view example to your engineered design. Maximize surface storage.
2. Provide beginning and ending stations for each facility. Provide stationing and/or dimensions and elevations at each inlet, outlet, check dam, planter corner and sidewalk notches.
3. Sidewalk elevation must be set above check dam and inlet elevations to allow overflow to drain to street before sidewalk.
4. Proposed utility lines to be located out of facility.
5. Longitudinal slope of planter matches the road, unless otherwise specified.
6. Area and Depth of facility are based upon engineering calculations and right-of-way constraints. See Chapter 2 of the City of Portland Stormwater Management Manual (SMMM).
7. Minimum interior planter width is 3 feet. A minimum of 4 feet is required for planters with street trees.
8. May use concrete or pavers per City Standards.
9. Place one notch at low point of sidewalk. Space additional notches approximately 6ft. apart.

RELATED DETAILS AND RESOURCES:

10. Metal Inlet details SW-335A and SW-336
11. Check Dam details SW-342 and SW-343
12. Special requirements for water lines, meters, and fire hydrants (see SW-316A)
13. Planter Planting Template (see SW-315)
14. Curb and Gutter per PBOT standard drawing P-540
15. Stormwater facility construction and blended soil requirements see City of Portland Standard Construction Specifications, sections 00415 and 01040.14(d)
16. Planter wall detail (see SW-313)

IMPORTANT: Utility conflicts and existing conditions can create major design variables. Locate utilities and survey existing conditions prior to beginning design work and include information on design drawings.

The Portland Bureau of Transportation (PBOT), Portland Water Bureau (PWB), and Bureau of Environmental Services (BES) are responsible for the review and approval of Stormwater Swales in the public right of way. Stormwater facilities in Wellhead Protection Areas may require special containment measures as required by City Code 21.35.

For more information contact:

PBOT (503) 823-7884 BES (503) 823-7761
PWB (503) 823-7368 Urban Forestry (503) 823-4489

STORMWATER MANAGEMENT MANUAL TYPICAL DETAILS

- Green Streets -

Plan View with Parking (2.5' Step-out)
Planters



Bureau of Environmental Services



NUMBER

SW-311A

7-1-2016

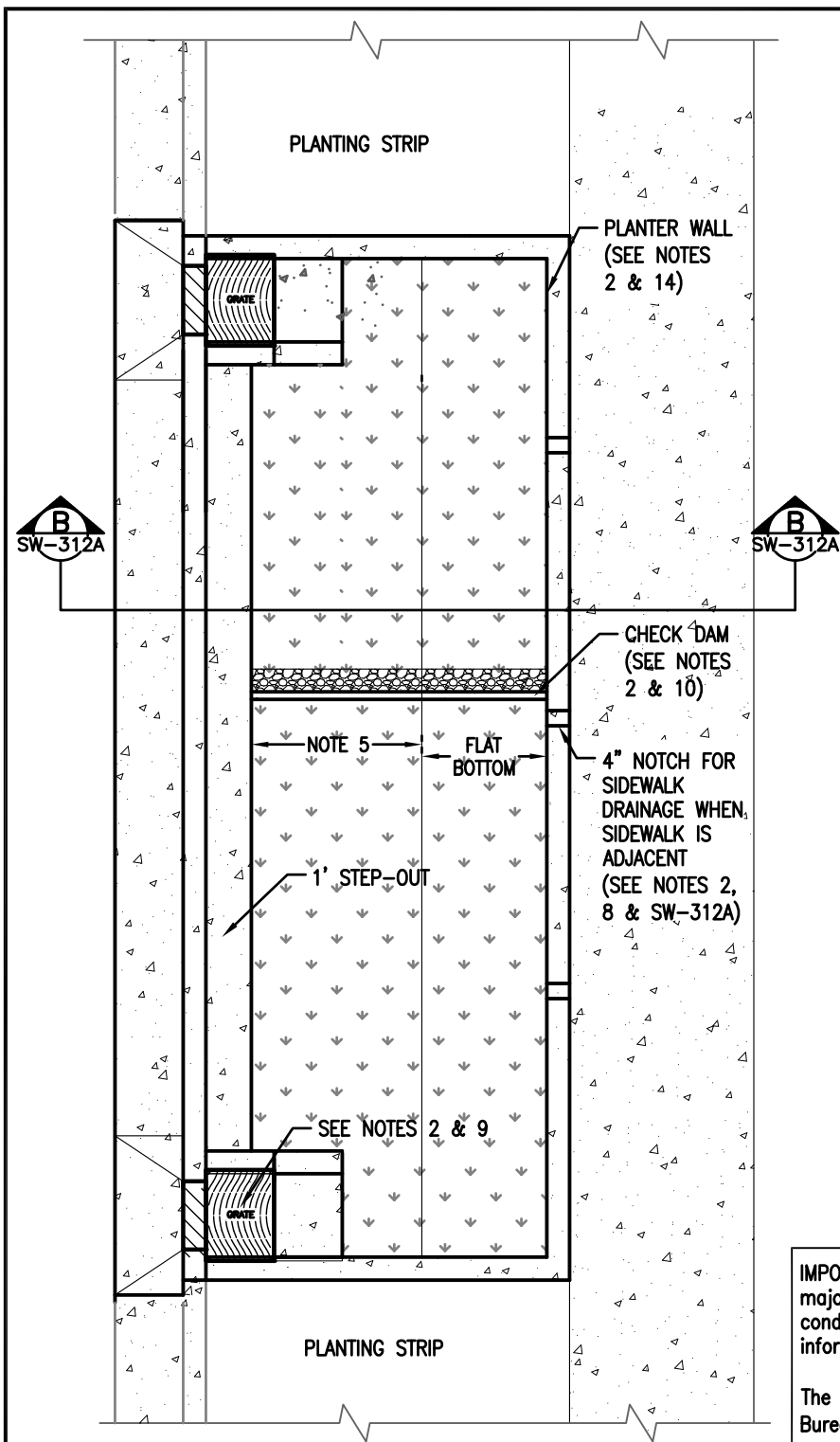

PLANTING STRIP

PLANTER WALL
(SEE NOTES
2 & 14)

CHECK DAM
(SEE NOTES
2 & 10)

NOTE 5

FLAT
BOTTOM

4" NOTCH FOR
SIDEWALK
DRAINAGE WHEN
SIDEWALK IS
ADJACENT
(SEE NOTES 2,
8 & SW-312A)

1' STEP-OUT

SEE NOTES 2 & 9

PLANTING STRIP

PLAN VIEW

DESIGNER INFORMATION:

1. Adapt this plan view example to your engineered design. Maximize surface storage.
2. Provide beginning and ending stations for each facility. Provide stationing and/or dimensions and elevations at each inlet, outlet, check dam, notch and wall corner.
3. Sidewalk elevation must be set above check dam and inlet elevations to allow overflow to drain to street before sidewalk.
4. Existing utility lines must be sleeved or relocated. Proposed utility lines to be located out of facility.
5. Slope 3:1. See section on SW-312A.
6. Longitudinal slope of planter matches the road, unless otherwise specified.
7. Area and Depth of facility are based upon engineering calculations and right-of-way constraints. See Chapter 2 of the City of Portland Stormwater Management Manual (SWMM)
8. Place one notch at low point of sidewalk. Space additional notches approximately 6ft. apart.

RELATED DETAILS AND RESOURCES:

9. Inlet and grate details SW-332, SW-335B and SW-336
10. Check Dam details SW-342 and SW-343
11. Special requirements for water lines, meters, and fire hydrants (see SW-316B)
12. Planting Template (see SW-315)
13. Curb and Gutter per PBOT standard drawing P-540.
14. Stormwater facility construction and blended soil requirements see City of Portland Standard Construction Specifications, sections 00415 and 01040.14(d)
15. Planter Wall Detail (See SW-313)

IMPORTANT: Utility conflicts and existing conditions can create major design variables. Locate utilities and survey existing conditions prior to beginning design work and include information on design drawings.

The Portland Bureau of Transportation (PBOT), Portland Water Bureau (PWB), and Bureau of Environmental Services (BES) are responsible for the review and approval of Stormwater Swales in the public right of way. Stormwater facilities in Wellhead Protection Areas may require special containment measures as required by City Code 21.35.

For more information contact:

PBOT (503) 823-7884 BES (503) 823-7761
PWB (503) 823-7368 Urban Forestry (503) 823-4489

- DRAWING NOT TO SCALE -

STORMWATER MANAGEMENT MANUAL TYPICAL DETAILS

- Green Streets -

Plan View with Parking (1' Step-Out)
Planters



Bureau of Environmental Services



NUMBER

SW-311B

7-1-2016

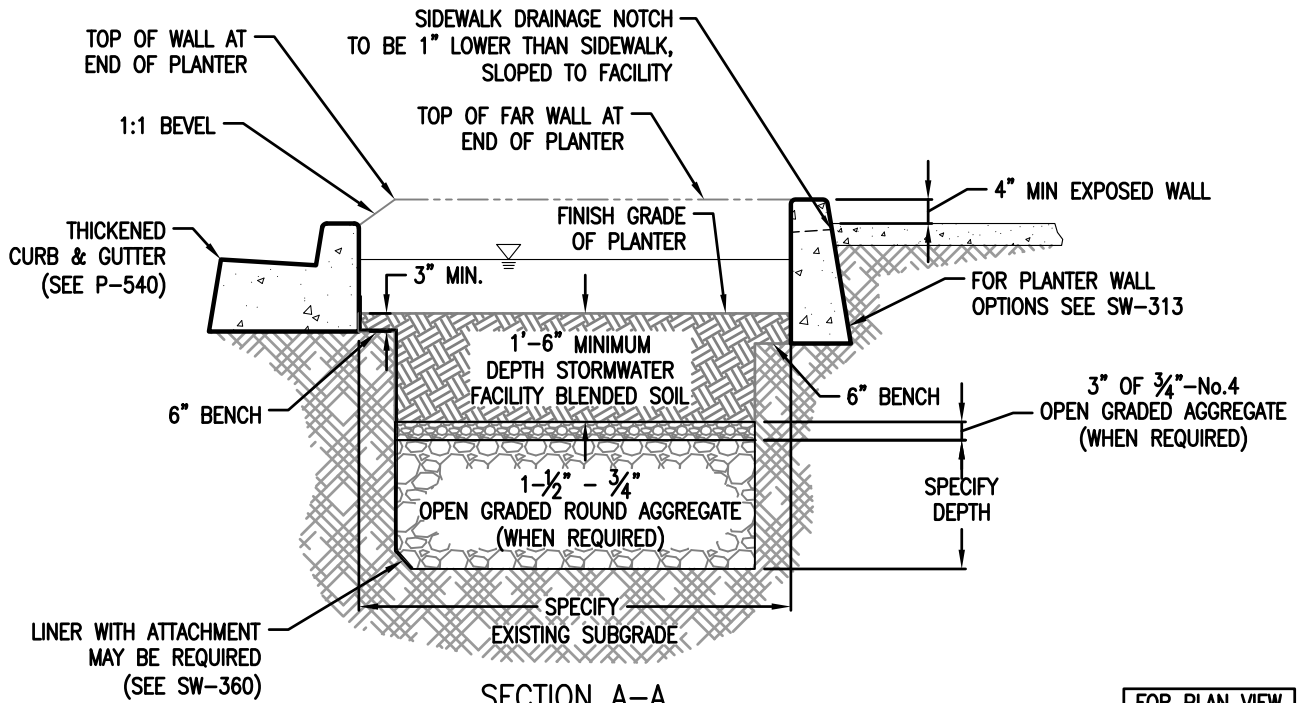

SECTION A-A
PLANTER WITHOUT PARKING

FOR PLAN VIEW
SEE SW-310

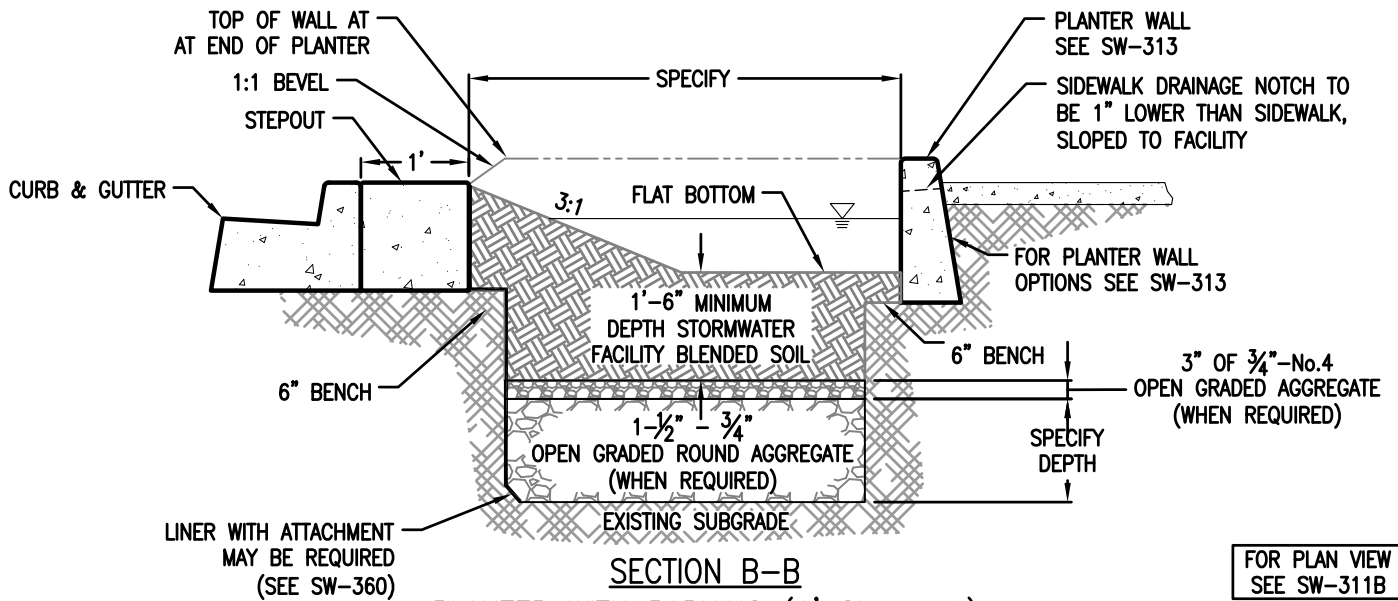

SECTION B-B
PLANTER WITH PARKING (1' Step-out)

FOR PLAN VIEW
SEE SW-311B

DESIGNER INFORMATION

1. Show liner and perf-pipe in the Section view if they are required.
2. Maximize 9" of surface storage.
3. Minimum facility width is 30" from back of curb to face of planter wall.
4. Top of curb and top of sidewalk at approximately same elevation, unless stormwater facility retrofit.

CONSTRUCTION NOTE

In facilities that are unlined, fracture and loosen soil to a depth of 12" below grade before installing blended soil or aggregate. Do not till.

- DRAWING NOT TO SCALE -

STORMWATER MANAGEMENT MANUAL TYPICAL DETAILS



Bureau of Environmental Services

- Green Streets -
Section Views
Planters



NUMBER

SW-312A

7-1-2016

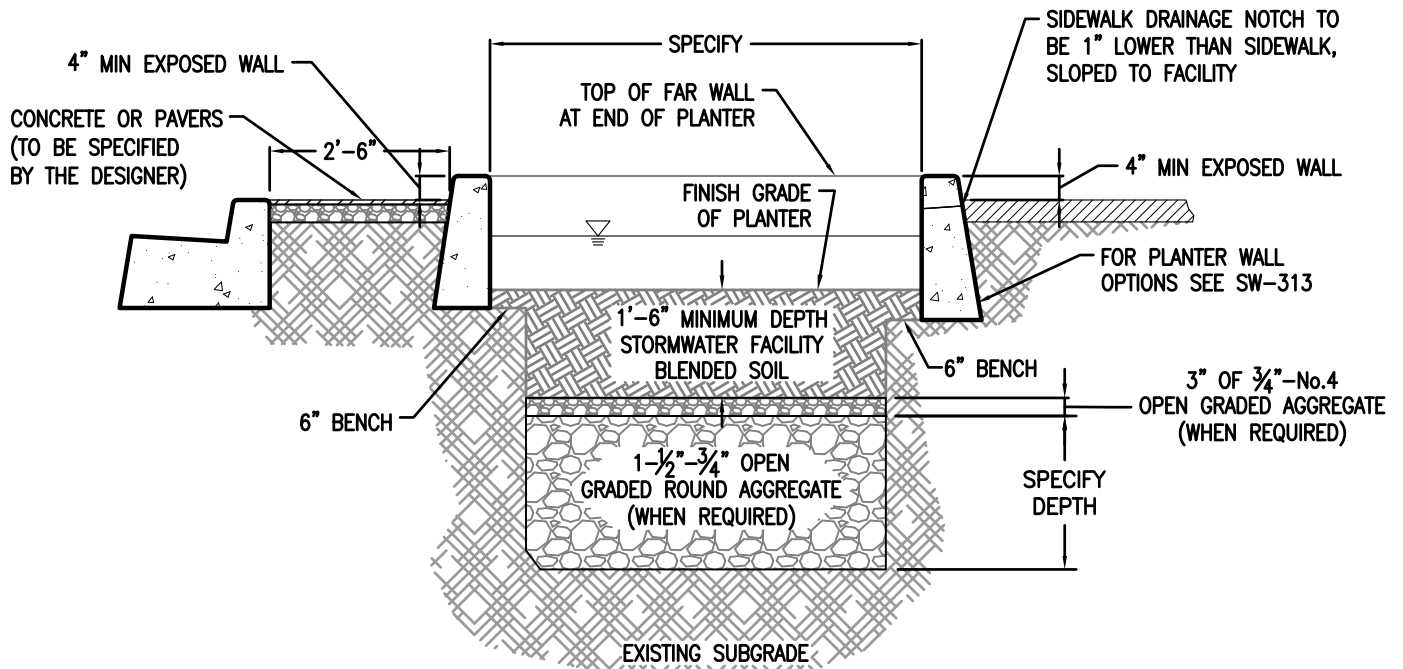

SECTION A-A
 PLANTER WITH PARKING (2.5' STEP-OUT)

FOR PLAN VIEW
 SEE SW-311A

DESIGNER INFORMATION

1. Show liner and perf-pipe in the Section view if they are required.
2. Maximize 9" of surface storage.
3. Typical facility width is 8' from back of curb to sidewalk.
4. Top of curb and top of sidewalk at approximately same elevation, unless stormwater facility retrofit.

CONSTRUCTION NOTE

In facilities that are unlined, fracture and loosen soil to a depth of 12" below grade before installing blended soil or aggregate. Do not till.

- DRAWING NOT TO SCALE -

STORMWATER MANAGEMENT MANUAL TYPICAL DETAILS



Bureau of Environmental Services

- Green Streets -
 Section View (2.5' Step-out)
 Planters



NUMBER

SW-312B

7-1-2016

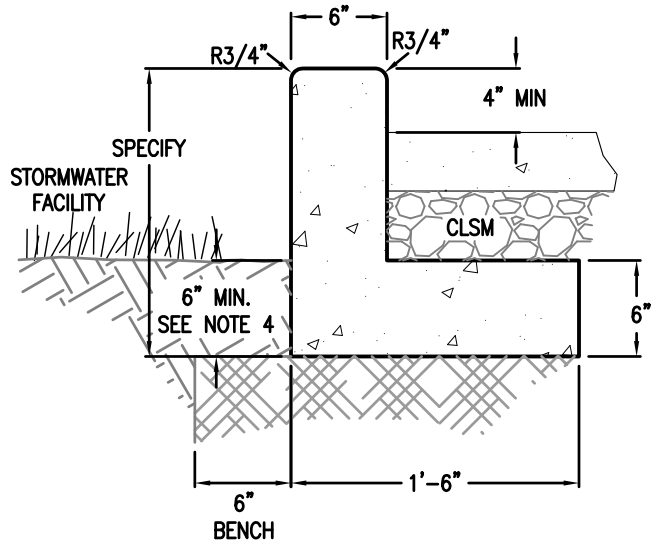
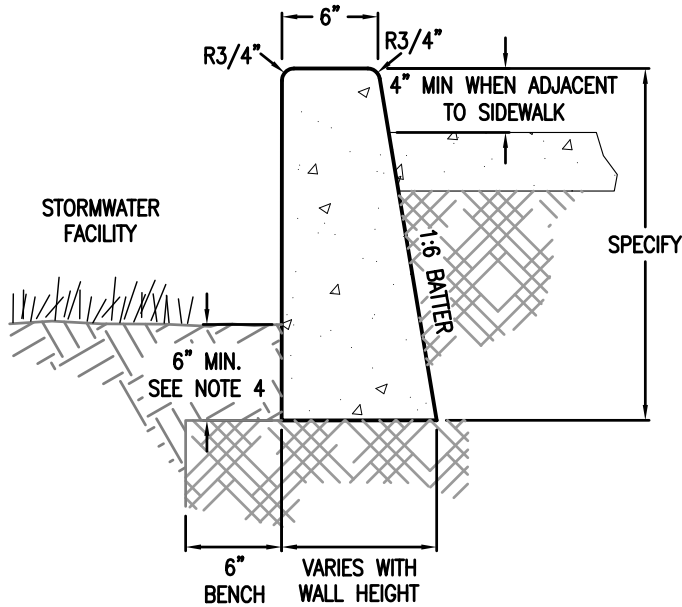

DESIGNER INFORMATION

1. Special design considerations or structural review may be required for longer planter wall spans. Steel reinforcement or additional concrete check dams may be needed for stability.
2. Specify one of the above planter wall options based on site conditions.
3. Maintain 1:6 batter for walls and 4" minimum from top of wall to top of sidewalk.
4. If a liner is used, See SW-360.

CONSTRUCTION NOTE

Finish all exposed concrete surfaces. See Specs.

- DRAWING NOT TO SCALE -

STORMWATER MANAGEMENT MANUAL TYPICAL DETAILS



Bureau of Environmental Services

- Green Streets -
Planter Wall Details
Planters



NUMBER



SW-313

7-1-2016

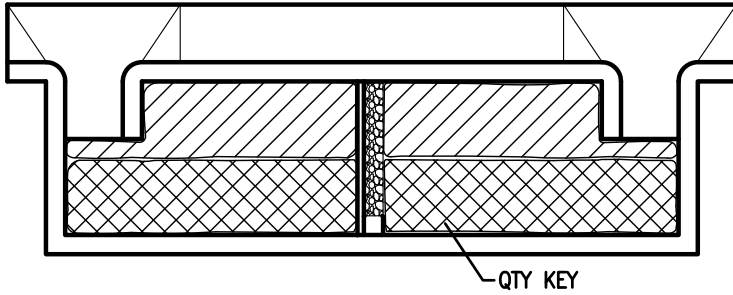
TEMPLATE 1



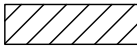

PLANT LEGEND 1

Symbol	Botanical Name	Common Name
	<i>Juncus patens</i>	Spreading rush
	<i>Carex obnupta</i>	Slough sedge

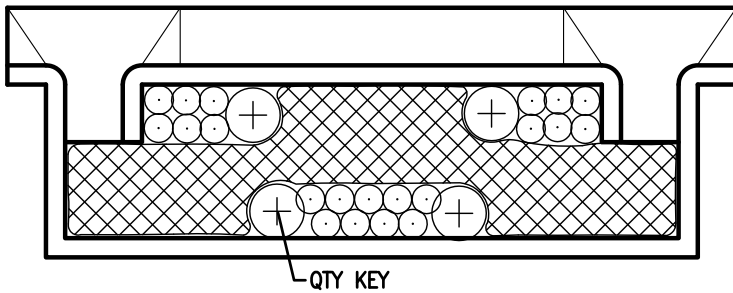

TEMPLATE 2



PLANT LEGEND 2

Symbol	Botanical Name	Common Name
	<i>Carex obnupta</i>	Slough sedge
	<i>Liriope muscari</i> "Big Blue"	Big blue lily turf
	<i>Cornus sericea</i> "Kelsey"	Kelsey dogwood

SAMPLE PLANT LEGEND

SYMBOL	BOTANIC NAME	COMMON NAME	SIZE	SQ. FOOT AREA – ZONE A	
				SPACING	QTY. ZONE A
	Xxxxx xxxxx	xxxxx	X	X	X
	Xxxxx xxxxx	xxxxx	X	X	X

INSTRUCTIONS

1. Choose a template and alter it to design. These are examples of approved planting templates. Other planting plans may be approved.
2. Plant lists and on-center spacing requirements are found in Section 2.4.1 of the City of Portland Stormwater Management Manual.
3. Planting legend required. State plant species, spacing, and quantities per Zone A and Zone B and per facility. Include the square footage of Zone A and B.
4. Planting Plans shall include labels for each plant group identifying the plant species and quantity in the group.
5. See detail SW-363 for plant spacing.

- DRAWING NOT TO SCALE -

STORMWATER MANAGEMENT MANUAL TYPICAL DETAILS



Bureau of Environmental Services

- Green Streets -
Landscape Planting Templates
Planters



NUMBER

SW-315

7-1-2016

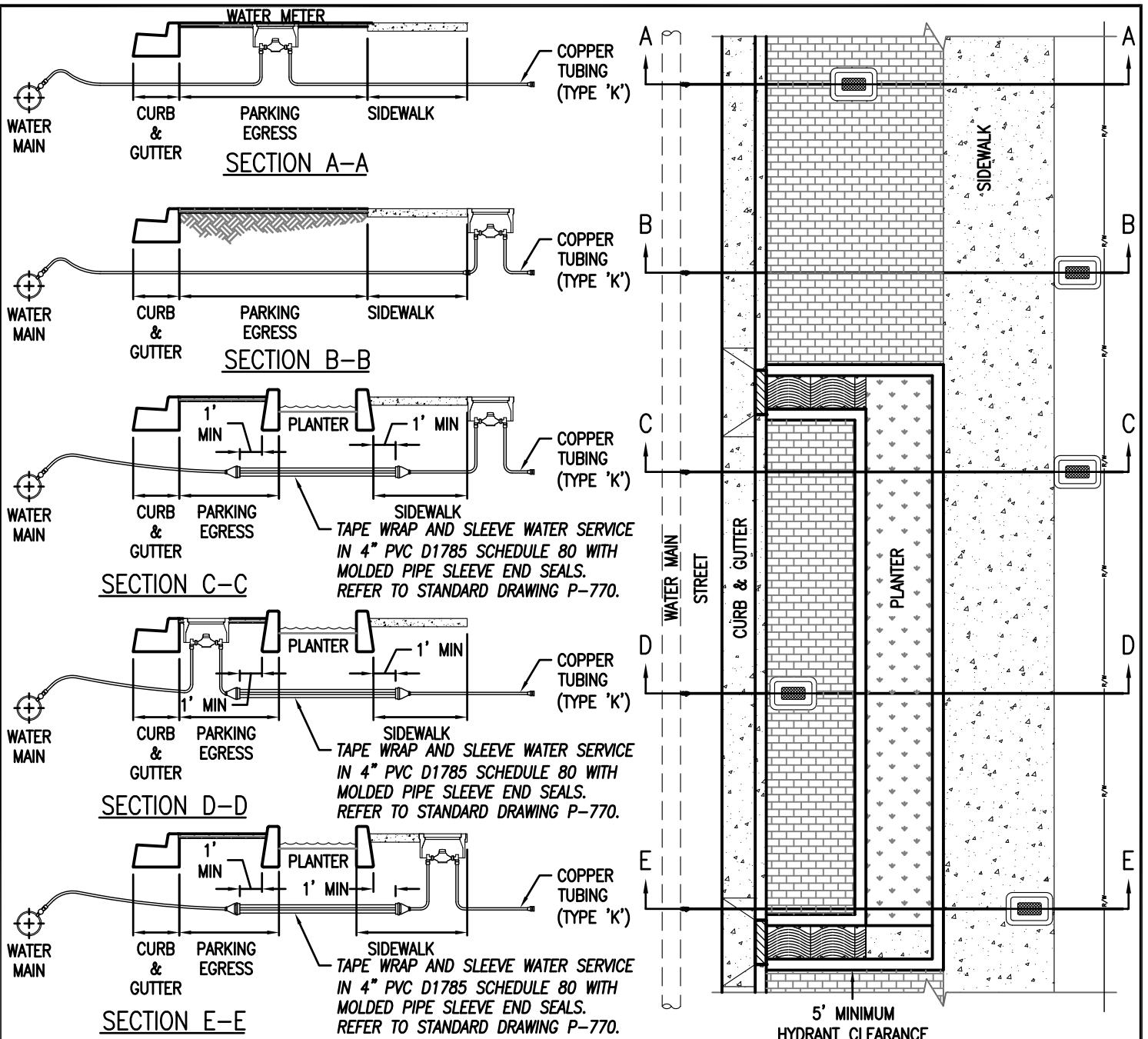

DESIGNER INFORMATION

1. Refer to Fire Hydrant Assembly Standard Drawing P-700. Center of hydrants must have min 5 ft clearance to the outside edge of stormwater facility.
2. Standard meter location is Option A. Option B or C can be used only if a minimum of 3' is available between the back of sidewalk and the Right-of-Way line. Option D and E can only be used for an existing service and when other options are infeasible, where a minimum of 1' is available between the back of sidewalk and the Right-of-Way line, and it requires a Design Exception from PBOT to be obtained by the project owner. In addition, for Option D, 3' minimum parking egress area is required for placement of 1" or smaller water meter, and 5' minimum for placement of 1.5" and 2" water meter.
3. Refer to 1" Service Assembly Standard Drawing P-780. For larger services or other appurtenances, contact PWB development services at (503) 823-7368. Water service line must be 2 ft min. from bottom of stormwater facility blended soil.
4. Maintain 2 ft skin-to-skin separation distance between the face of gutter pan and the water main. If water main is < 2 ft from face of gutter pan, the water main must be relocated unless otherwise approved by PWB. Verification of water main depth is required prior to PWB approval.
5. Cross-section views are not required on construction plans.

- DRAWING NOT TO SCALE -

STORMWATER MANAGEMENT MANUAL TYPICAL DETAILS

- Green Streets -
Meter & Hydrant Locations
Planters



Bureau of Environmental Services



NUMBER

SW-316A

7-1-2016

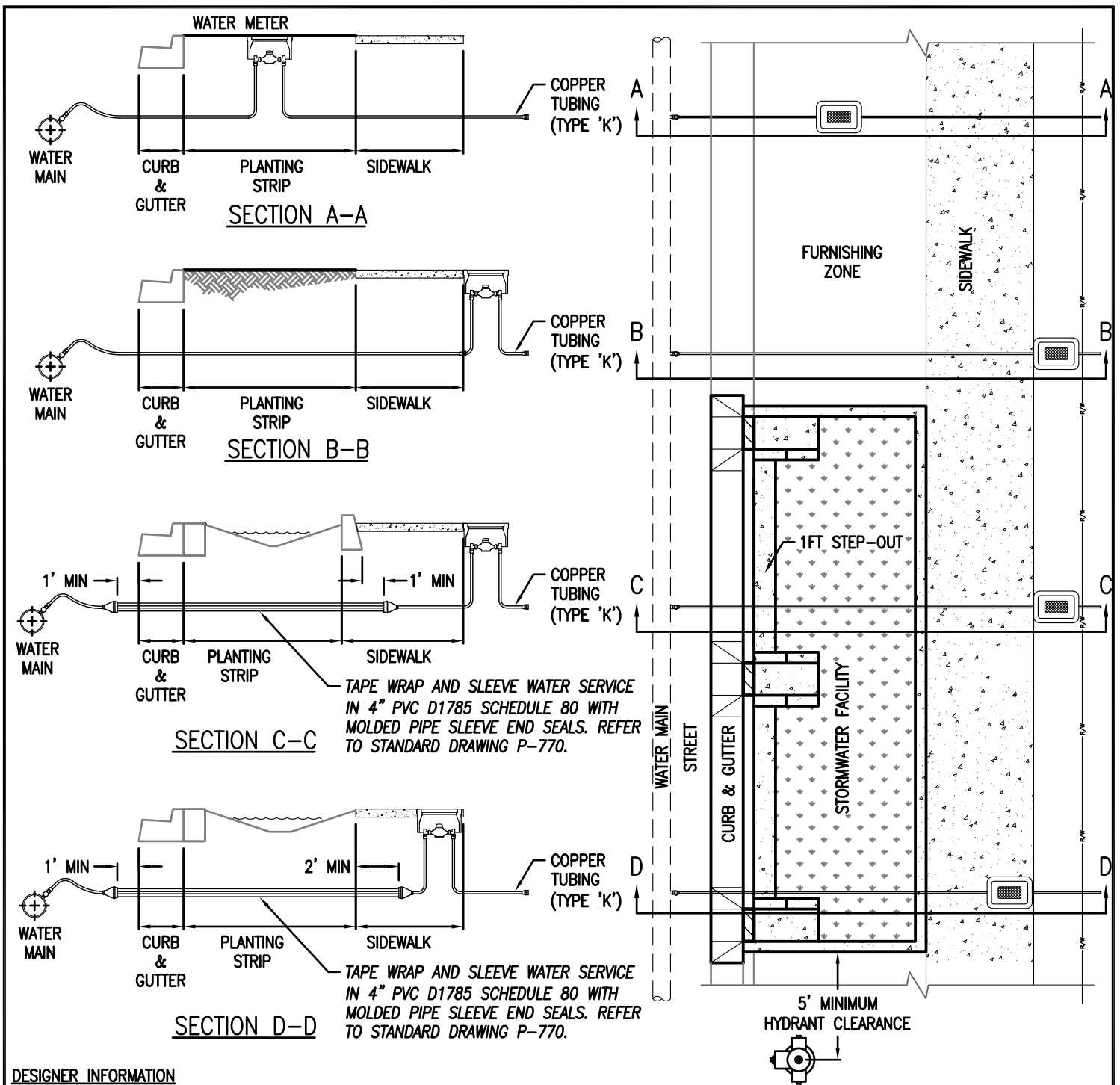

DESIGNER INFORMATION

1. Refer to Fire Hydrant Assembly Standard Drawing P-700. Center of hydrants must have min 5 ft clearance to the outside edge of stormwater facility.
2. Standard meter location is Option A. Option B or C can be used only if a minimum of 3' is available between back of sidewalk and the Right-of-Way line. Option D can only be used for an existing service when other options are infeasible, where a minimum of 1' is available between the back of sidewalk and the Right-of-Way line, and it requires a Design Exception from PBOT, to be obtained by the project owner.
3. Refer to 1" Service Assembly Standard Drawing P-780. For larger services or other appurtenances, contact PWB development services at (503) 823-7368. Water service line must be 2 ft min. from bottom of stormwater facility blended soil.
4. Maintain 2 ft skin-to-skin separation distance between the face of gutter pan and the water main. If water main is < 2 ft from face of gutter pan, the water main must be relocated unless otherwise approved by PWB. Verification of water main depth is required prior to PWB approval.
5. Cross-section views are not required on construction plans.

- DRAWING NOT TO SCALE -

STORMWATER MANAGEMENT MANUAL TYPICAL DETAILS



Bureau of Environmental Services

- Green Streets -
Meter & Hydrant Locations
 Planter with 1' Step-out



NUMBER

SW-316B

7-1-2016

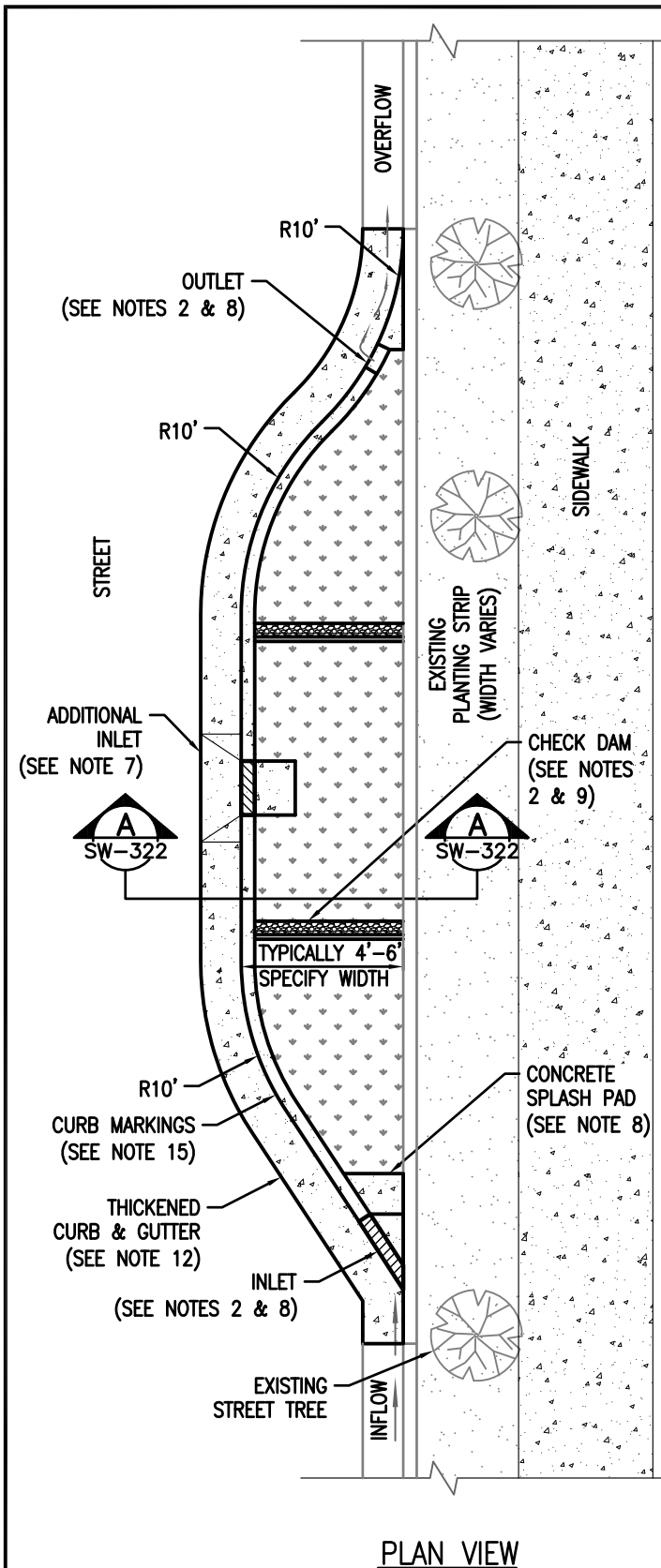

- DRAWING NOT TO SCALE -

DESIGNER INFORMATION:

1. Adapt this plan view example to your engineered design. Maximize surface storage.
2. Provide beginning and ending stations for each facility. Provide stationing and/or dimensions and elevations at each inlet, outlet, check dam, planter corner and sidewalk notches.
3. Sidewalk elevation must be set above check dam and inlet elevations to allow overflow to drain to street before sidewalk.
4. Proposed utility lines to be located out of facility.
5. Longitudinal slope of planter matches the road.
6. Area and Depth of facility are based upon engineering calculations and right-of-way constraints. See Chapter 2 of the City of Portland Stormwater Management Manual (SWMM).
7. Additional inlets in facilities over 25 feet in length per BES or site-specific requirements.

RELATED DETAILS AND RESOURCES:

8. Inlet and outlet details SW-331, SW-332, SW-333 and SW-334
9. Check Dam details SW-342 and SW-343
10. Special requirements for water lines, meters, and fire hydrants (see SW-316)
11. Planter Planting Template (see SW-323)
12. Thickened Curb and Gutter (see PBOT standard drawing P-540)
13. Stormwater facility construction and blended soil requirements see City of Portland Standard Construction Specifications, sections 00415 and 01040.14(d)
14. Planter wall detail (see SW-313)
15. Pavement markings see PBOT standard drawing P-434

IMPORTANT: Utility conflicts and existing conditions can create major design variables. Locate utilities and survey existing conditions prior to beginning design work and include information on design drawings.

The Portland Bureau of Transportation (PBOT), Portland Water Bureau (PWB), and Bureau of Environmental Services (BES) are responsible for the review and approval of Stormwater Swales in the public right of way. Stormwater facilities in Wellhead Protection Areas may require special containment measures as required by City Code 21.35.

For more information contact:

PBOT	(503) 823-7884	BES	(503) 823-7761
PWB	(503) 823-7368	Urban Forestry	(503) 823-4489

STORMWATER MANAGEMENT MANUAL TYPICAL DETAILS



Bureau of Environmental Services

- Green Streets -
In-Street Plan View
Curb Extensions



NUMBER

SW-320

7-1-2016

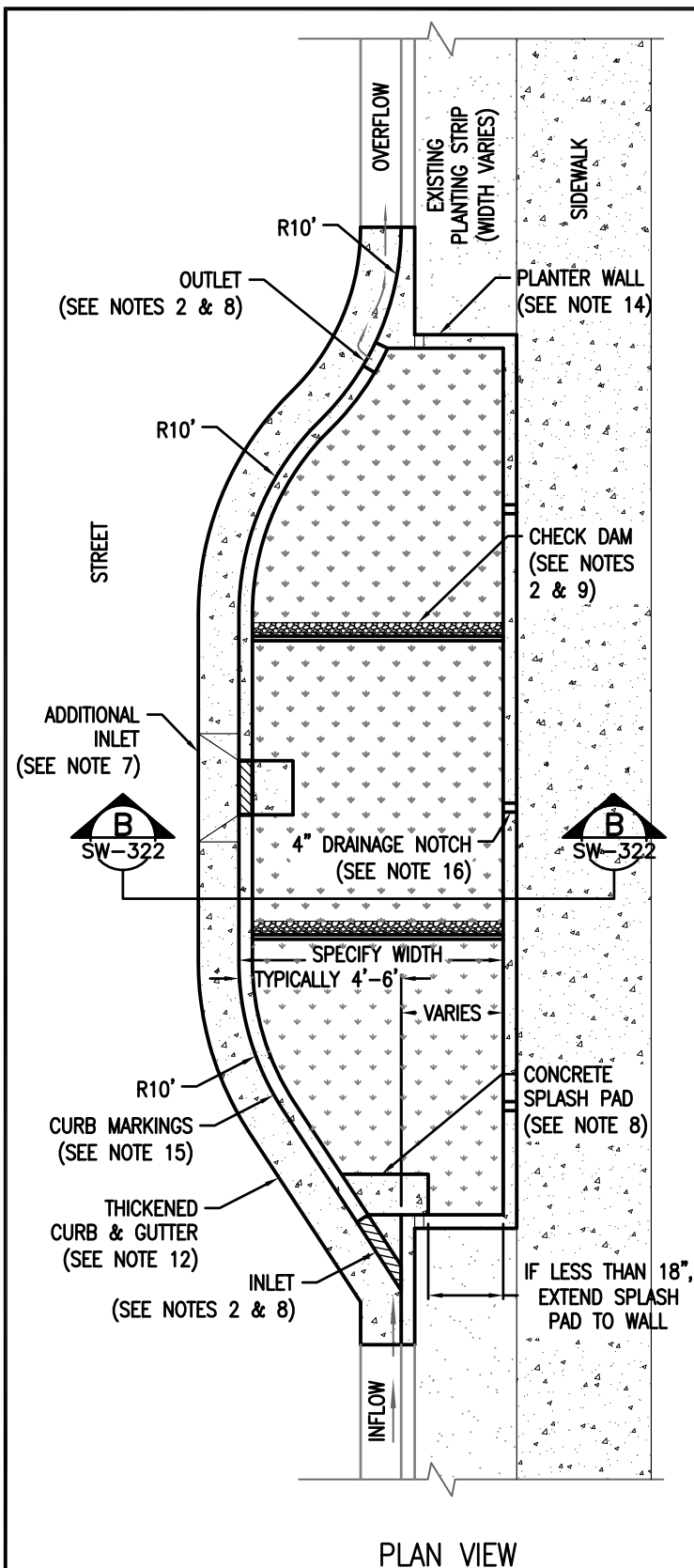

PLAN VIEW

DESIGNER INFORMATION:

1. Adapt this plan view example to your engineered design. Maximize surface storage.
2. Provide beginning and ending stations for each facility. Provide stationing and/or dimensions and elevations at each inlet, outlet, check dam, planter corner and sidewalk notches.
3. Sidewalk elevation must be set above check dam and inlet elevations to allow overflow to drain to street before sidewalk.
4. Existing utility lines must be sleeved or relocated. Proposed utility lines to be located out of facility.
5. Longitudinal slope of planter matches the road.
6. Area and depth of facility are based upon engineering calculations and right-of-way constraints. See Chapter 2 of the City of Portland Stormwater Management Manual (SWMM).
7. Additional inlets in facilities over 25 feet in length per BES or site-specific requirements.

RELATED DETAILS AND RESOURCES:

8. Inlet and outlet details SW-331, SW-332, SW-333 and SW-334
9. Check Dam details SW-342 and SW-343
10. Special requirements for water lines, meters, and fire hydrants (see SW-324)
11. Planter Planting Template (see SW-323)
12. Thickened Curb and Gutter per PBOT standard drawing P-540
13. Stormwater facility construction and blended soil requirements see City of Portland Standard Construction Specifications, sections 00415 and 01040.14(d)
14. Planter wall detail (see SW-313)
15. Pavement Markings (see PBOT standard drawing P-434)
16. 4" Sidewalk-Drainage Notch (see SW-322): Place one notch at the low point of the sidewalk and place additional notched approximately 6' apart.

IMPORTANT: Utility conflicts and existing conditions can create major design variables. Locate utilities and survey existing conditions prior to beginning design work and include information on design drawings.

The Portland Bureau of Transportation (PBOT), Portland Water Bureau (PWB), and Bureau of Environmental Services (BES) are responsible for the review and approval of Stormwater Swales in the public right of way. Stormwater facilities in Wellhead Protection Areas may require special containment measures as required by City Code 21.35.

For more information contact:
 PBOT (503) 823-7884 BES (503) 823-7761
 PWB (503) 823-7368 Urban Forestry (503) 823-4489

- DRAWING NOT TO SCALE -

STORMWATER MANAGEMENT MANUAL TYPICAL DETAILS



- Green Streets -
 In-Planting-Strip Plan View
 Curb Extensions



NUMBER
 SW-321
 7-1-2016

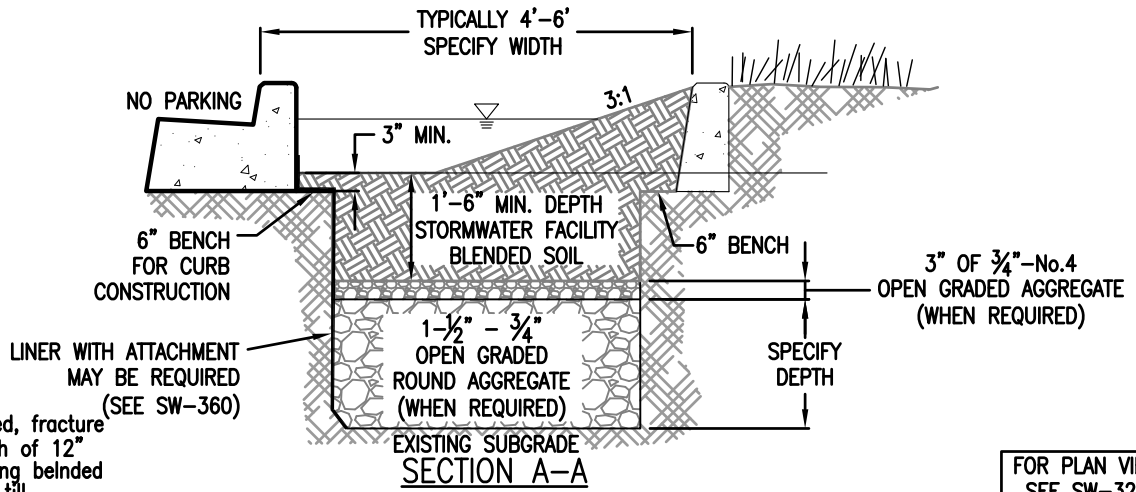

CONSTRUCTION NOTE

In facilities that are unlined, fracture and loosen soil to a depth of 12" below grade before installing belnded soil or aggregate. Do not till.

FOR PLAN VIEW
SEE SW-320

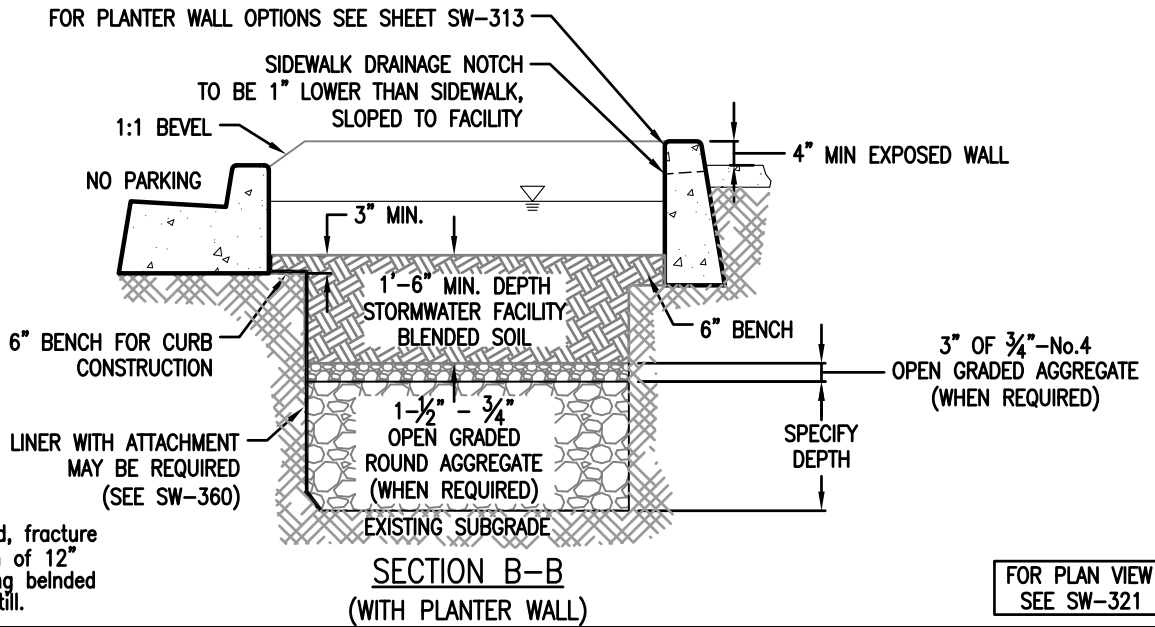

CONSTRUCTION NOTE

In facilities that are unlined, fracture and loosen soil to a depth of 12" below grade before installing belnded soil or aggregate. Do not till.

FOR PLAN VIEW
SEE SW-321

NOTES:

1. See SW-330 and SW-332 for inlet.
2. Show liner and perforated pipe in section, if required.
3. Maximum 10" of surface storage.

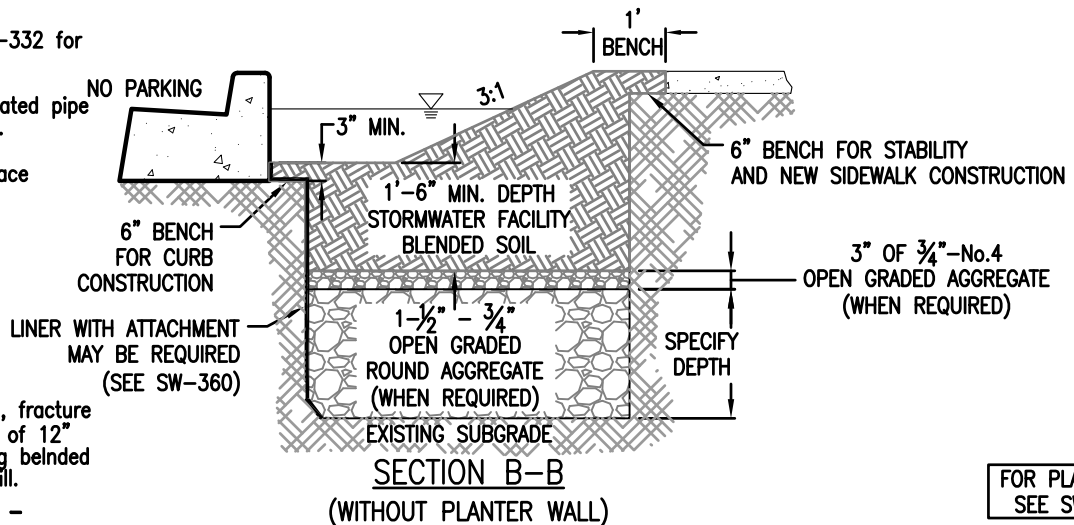

CONSTRUCTION NOTE

In facilities that are unlined, fracture and loosen soil to a depth of 12" below grade before installing belnded soil or aggregate. Do not till.

- DRAWING NOT TO SCALE -

FOR PLAN VIEW
SEE SW-321

STORMWATER MANAGEMENT MANUAL TYPICAL DETAILS

- Green Streets -
Section Views
Curb Extensions



Bureau of Environmental Services



NUMBER

SW-322

7-1-2016

TEMPLATE 1

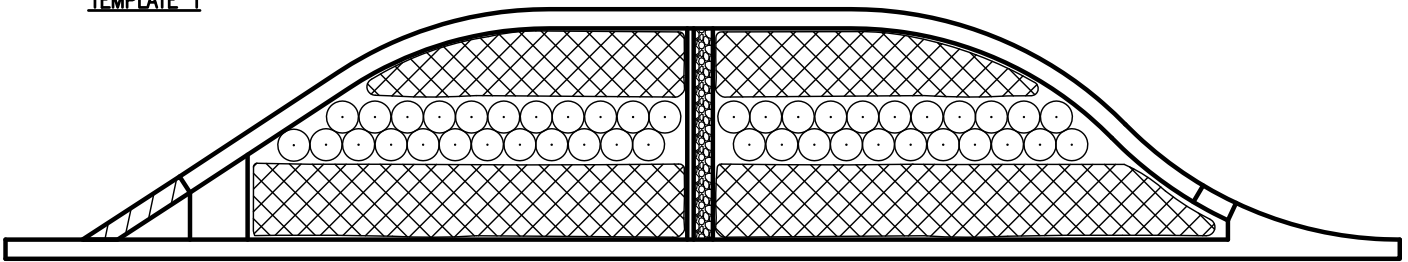

PLANT LEGEND 1

Symbol	Botanical Name Common Name
	<i>Carex obnupta</i> Slough sedge

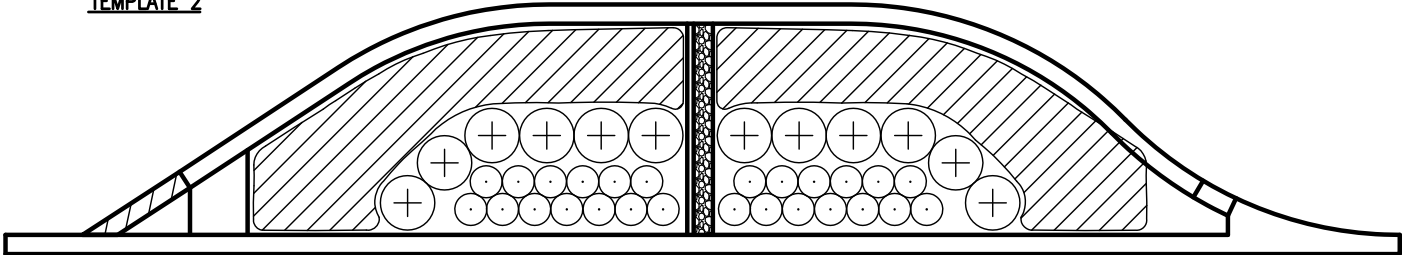

	<i>Juncus patens</i> Spreading rush
---	--

TEMPLATE 2





PLANT LEGEND 2

Symbol	Botanical Name Common Name
	<i>Juncus patens</i> Spreading Rush

	<i>Carex morrowii</i> 'Ice Dance' Ice Dance Sedge
	<i>Spiraea x bumalda</i> 'Goldflame' Goldflame spirea

SAMPLE PLANT LEGEND

SYMBOL	BOTANIC NAME	COMMON NAME	SIZE	SQ. FOOT AREA – ZONE A	
				SPACING	X QTY. ZONE A
	Xxxxx xxxxx	xxxxx	X	X	X
	Xxxxx xxxxx	xxxxx	X	X	X

INSTRUCTIONS

1. Choose a template and alter it to design. These are examples of approved planting templates. Other planting plans may be approved.
2. Plant lists and on-center spacing requirements are found in Section 2.4.1 of the City of Portland Stormwater Management Manual.
3. Planting legend required. State plant species, spacing, and quantities per Zone A and Zone B and per facility. Include the square footage of Zone A and B.
4. Planting Plans shall include labels for each plant group identifying the plant species and quantity in the group.
5. See detail SW-363 for plant spacing.

- DRAWING NOT TO SCALE -

STORMWATER MANAGEMENT MANUAL TYPICAL DETAILS



Bureau of Environmental Services

- Green Streets -
Landscape Planting Templates
Curb Extensions



NUMBER

SW-323

7-1-2016

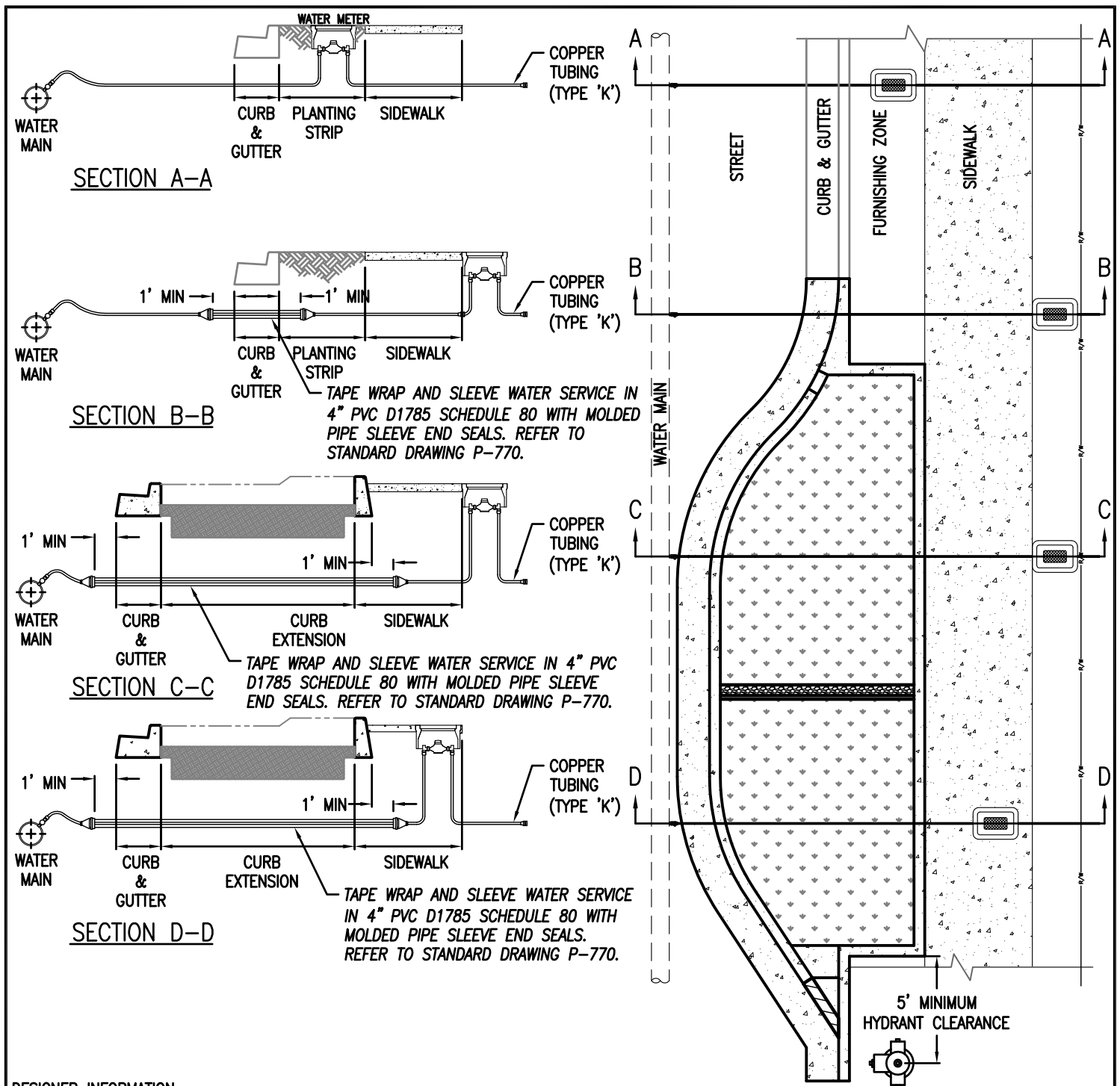

DESIGNER INFORMATION

1. Refer to Fire Hydrant Assembly Standard Drawing P-700. Center of hydrants must have min 5 ft clearance to the outside edge of stormwater facility.
2. Standard meter location is Option A, if Furnishing Zone is a minimum of 3' wide. Option B or C can be used only if a minimum of 3' is available between the back of sidewalk and the Right-of-Way line. Option D can only be used for an existing service when other options are infeasible, where a minimum of 1' is available between the back of sidewalk and the Right-of-Way line, and it requires a Design Exception from PDOT to be obtained by Project Engineer.
3. Refer to 1" Service Assembly Standard Drawing P-780. For larger services or other appurtenances, contact PWB development services at (503) 823-7368. Water service line must be 2 ft min. from bottom of stormwater facility imported soil blend.
4. Maintain 2 ft skin-to-skin separation distance between the face of gutter pan and the water main. If water main is < 2 ft from face of gutter pan, the water main must be relocated unless otherwise approved by PWB. Verification of water main depth is required prior to PWB approval.
5. Cross-section views are not required on construction plans.

- DRAWING NOT TO SCALE -

STORMWATER MANAGEMENT MANUAL TYPICAL DETAILS



Bureau of Environmental Services

- Green Streets -
Meter & Hydrant Locations
Curb Extensions



NUMBER

SW-324

7-1-2016

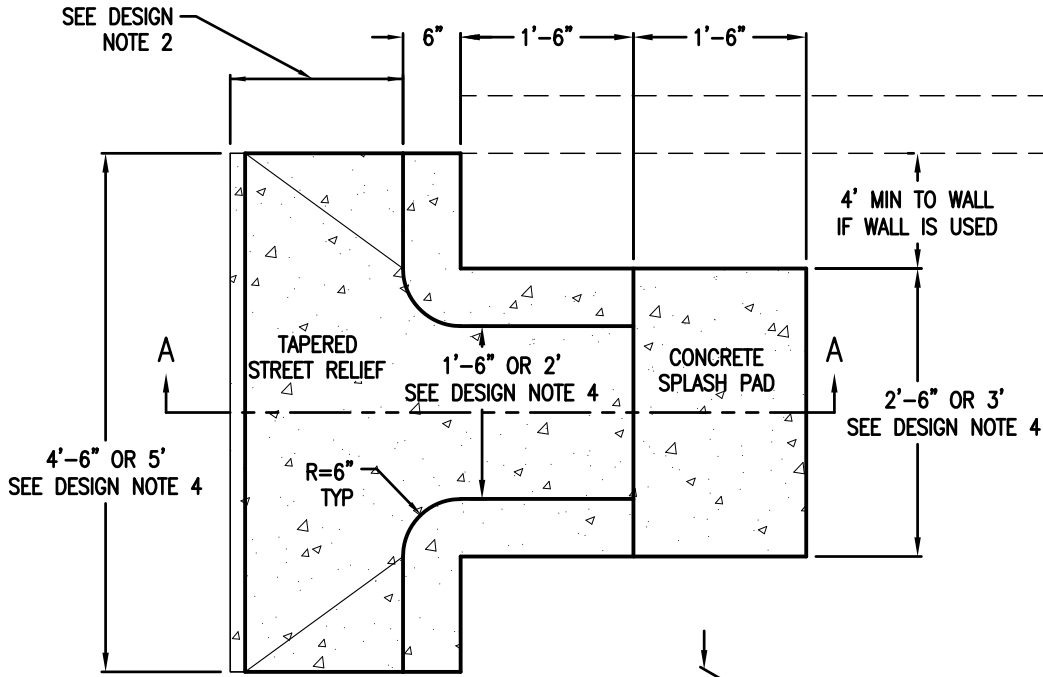

PLAN

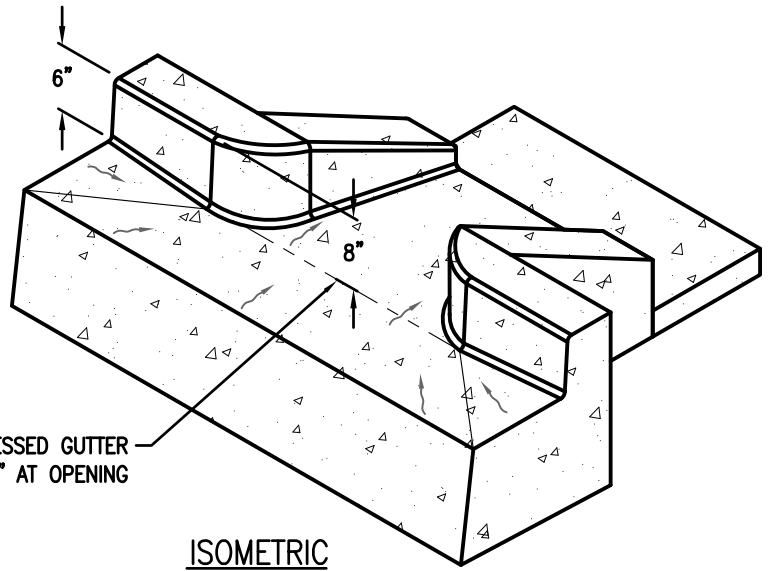

ISOMETRIC

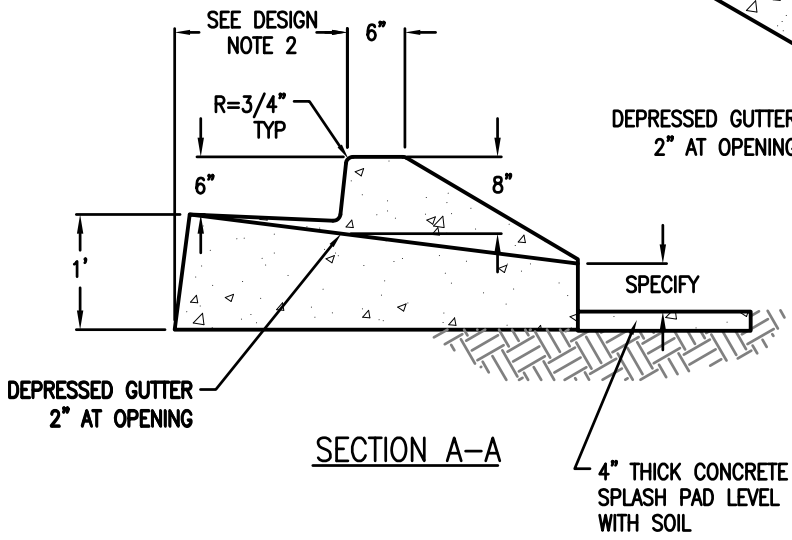

SECTION A-A

DESIGNER INFORMATION

1. For use with stormwater facilities with side slopes.
2. Refer to Standard Drawing P-540. Match gutter pan of adjacent curb and gutter.
3. Metal Inlet assembly, SW-332, required on high traffic streets.
4. Inlets on slopes greater than 5% may require 2 foot wide throat.

- DRAWING NOT TO SCALE -

STORMWATER MANAGEMENT MANUAL TYPICAL DETAILS



Bureau of Environmental Services

- Green Streets -
Concrete Inlet with Wingwalls
Curb Inlets



NUMBER

SW-330

7-1-2016

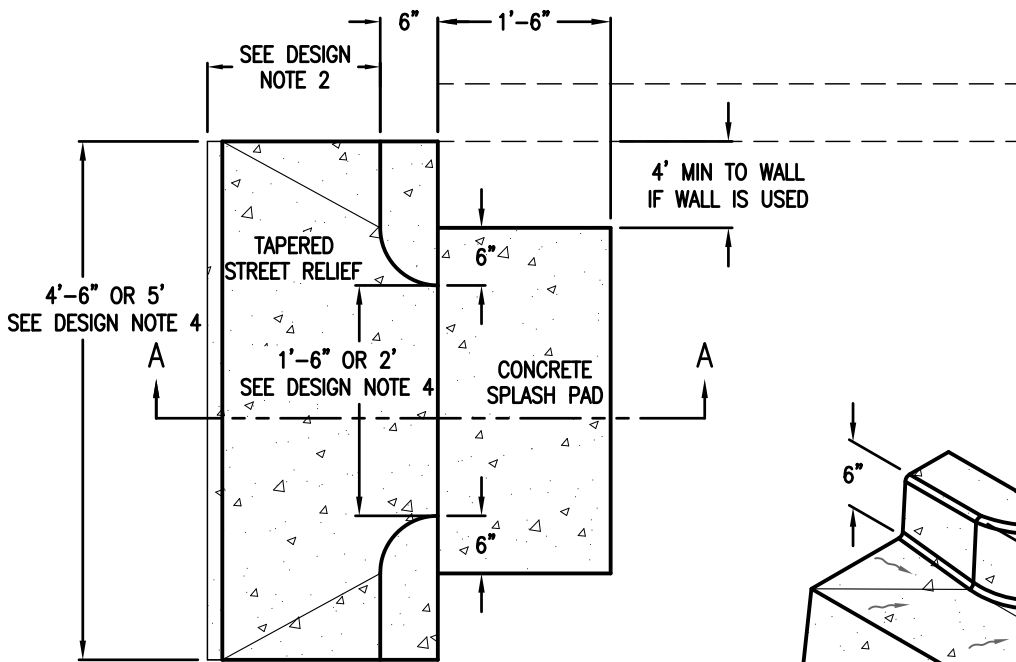

PLAN

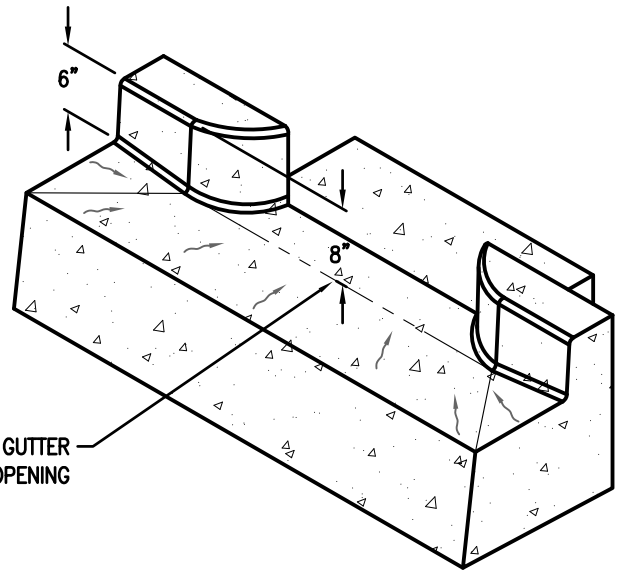

ISOMETRIC

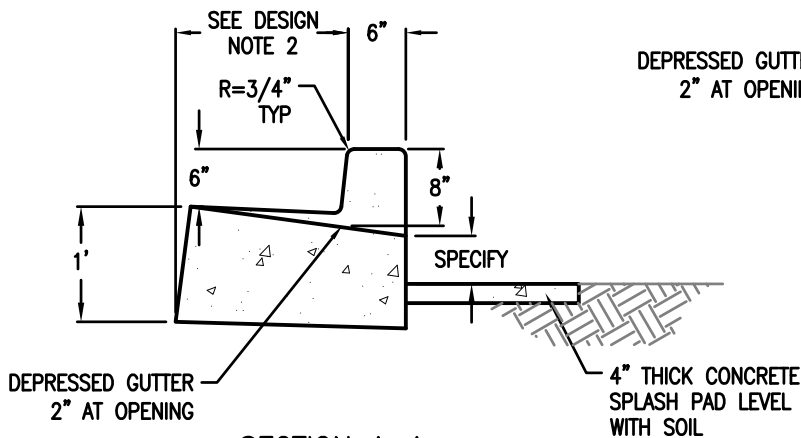

SECTION A-A

CONSTRUCTION NOTES

1. Concrete splash pad elevation shall be level with soil inside planter.
2. Splash pad shall be six inches wider than inlet opening on both sides.

DESIGNER INFORMATION

1. For use with planters. If planter inlet is adjacent to planter wall, then include wall in detail.
2. Refer to Standard Drawing P-540. Match gutter pan of adjacent curb and gutter.
3. Metal Inlet assembly, SW-332, required on high traffic streets.
4. Inlets on slopes greater than 5% may require 2 foot wide throat.
5. If there is a drop from inlet to splash pad, Metal Inlet Assembly, SW-332, is required

- DRAWING NOT TO SCALE -

STORMWATER MANAGEMENT MANUAL TYPICAL DETAILS



Bureau of Environmental Services

- Green Streets -
Concrete Inlet
Curb Inlets



NUMBER

SW-331

7-1-2016

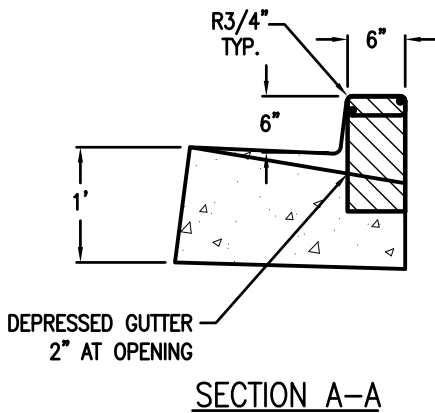
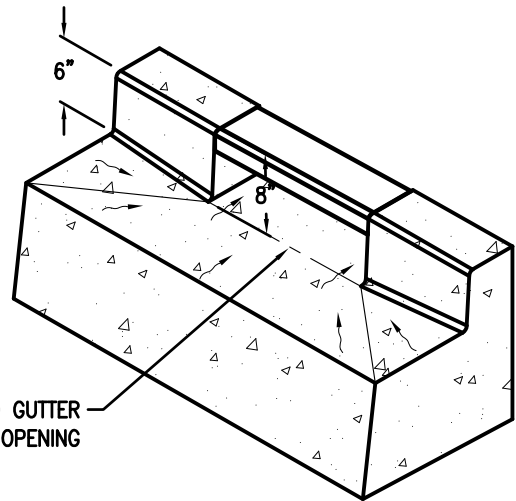
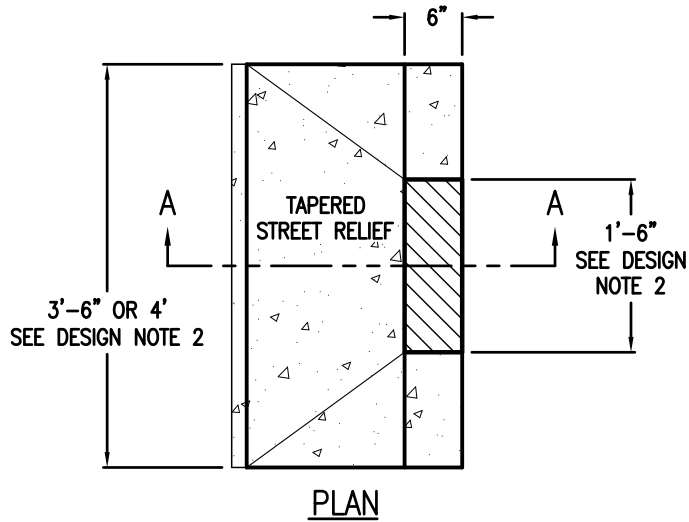

CONSTRUCTION NOTES:

1. Headed concrete anchors shall meet the requirements of ASTM A-108.
2. HSS 6 x 2 x 1/8 tube shall meet the requirements of ASTM A-500 Grade B.
3. End Plates shall meet the requirements of ASTM A-36.
4. Entire assembly shall be Hot-Dip Galvanized in accordance with ASTM A-123.

DESIGNER INFORMATION:

1. Refer to Standard Drawing p-540. Match gutter of adjacent curb and gutter.
2. Metal inlet width can be modified to 2' if site conditions require a 2' interior inlet width.

METAL INLET ASSEMBLY

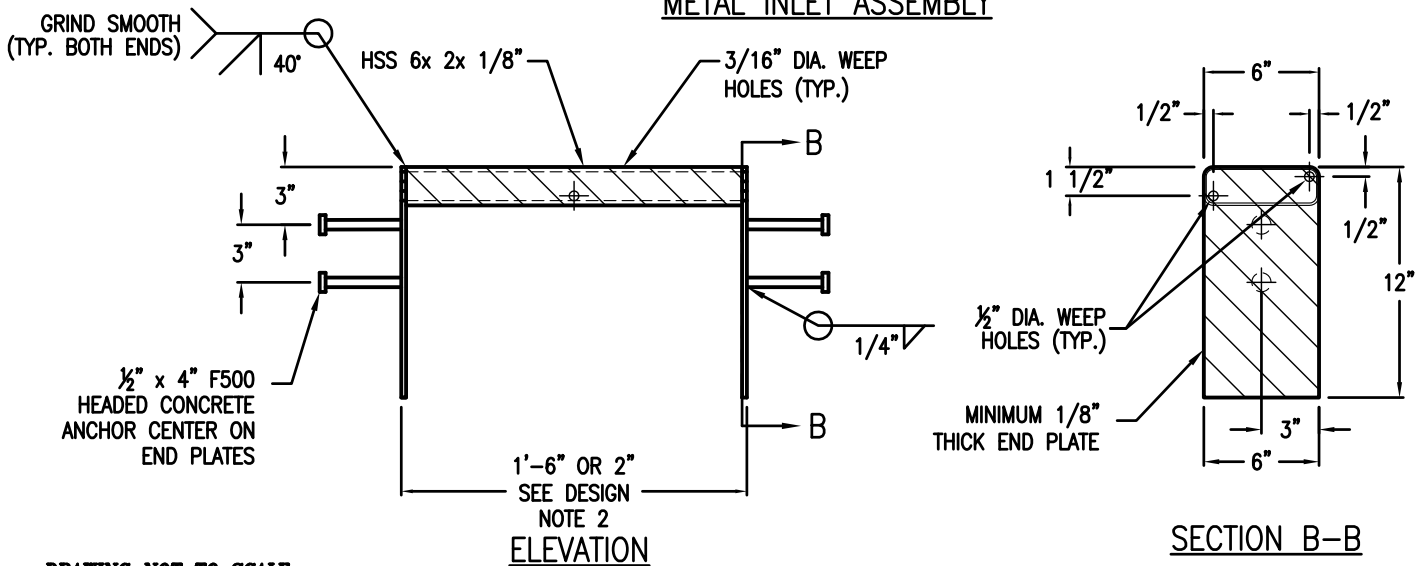

- DRAWING NOT TO SCALE -

STORMWATER MANAGEMENT MANUAL TYPICAL DETAILS

- Green Streets -
Metal Inlet
Curb Inlets



Bureau of Environmental Services



NUMBER

SW-332

7-1-2016

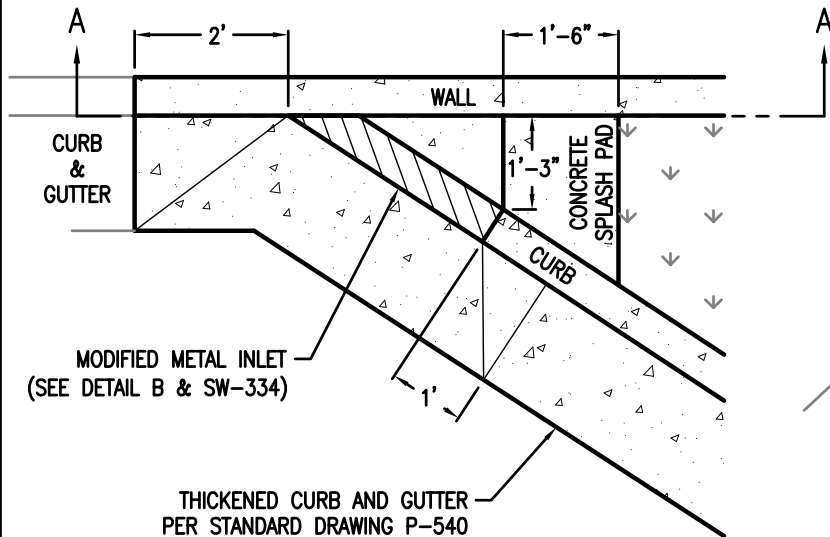

DETAIL A - INLET PLAN

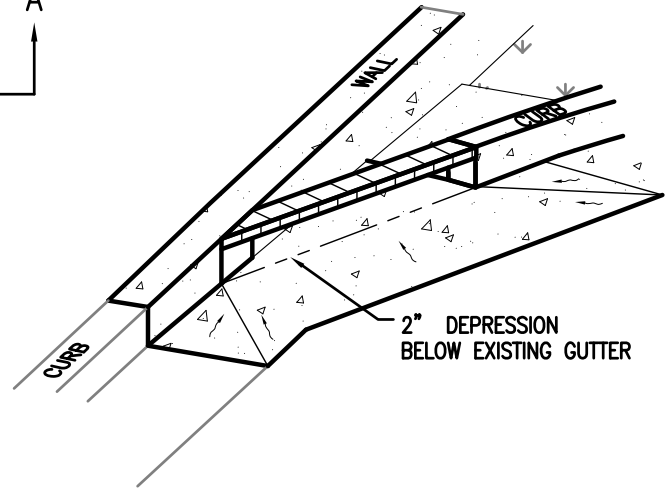

DETAIL B - INLET PERSPECTIVE

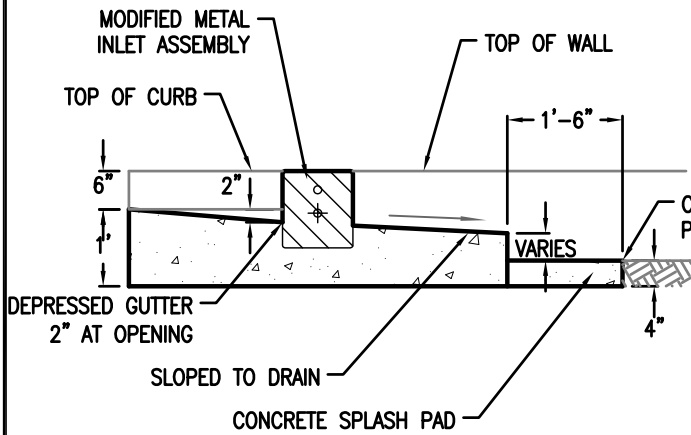

SECTION A-A

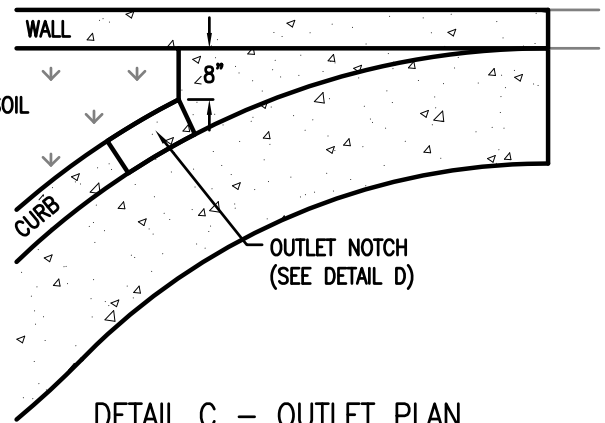

DETAIL C - OUTLET PLAN

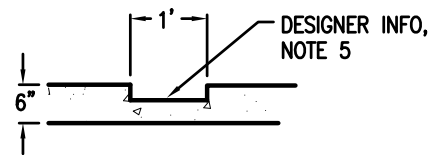

DETAIL D - OUTLET NOTCH

DESIGNER INFORMATION:

1. Additional concrete inlets, SW-331, can be added if necessary (preferably immediately downstream of each check dam to minimize potential backflow).
2. Sawcut beyond facility and transition existing curb to new curb and gutter at 1" per foot as necessary.
3. Inlet may be modified to maximize flow entry to stormwater facility.
4. Modify inlet and outlet design as needed for site.
5. Ensure outlet notch elevation is 2" below lowest inlets and sidewalk notches.
6. Concrete splash pad required at all inlets.

- DRAWING NOT TO SCALE -

STORMWATER MANAGEMENT MANUAL TYPICAL DETAILS



Bureau of Environmental Services

- Green Streets -
Inlet & Outlet for Curb Extensions
Curb Inlets



NUMBER

SW-333

7-1-2016

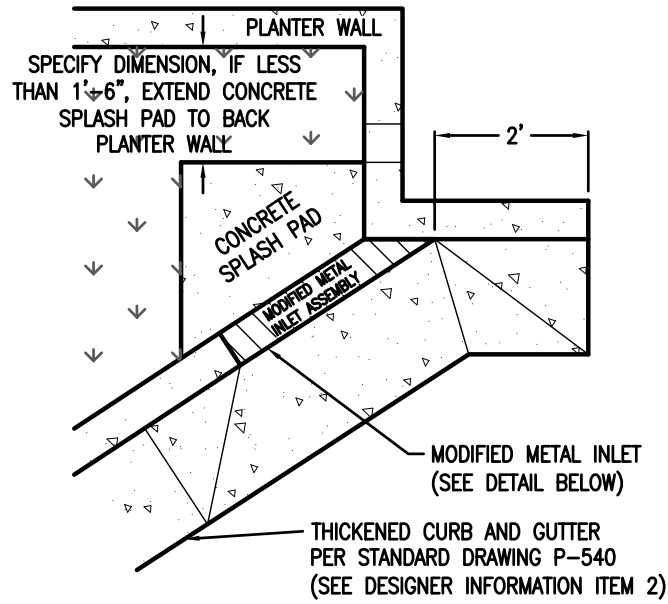

PLAN

DESIGNER INFORMATION:

1. Splash pad is required at all inlets.
2. Refer to Standard Drawing P-540. Match gutter pan of adjacent curb and gutter.
3. Design vertical wheel load is 8.5kips (1/2 of tandem axle weight specified in FHWA-HOP-06-105).

CONSTRUCTION NOTES:

1. Headed concrete anchors shall meet the requirements of ASTM A-108.
2. HSS 6 x 2 x 1/4 Tube Channel shall meet the requirements of ASTM A-500 Grade B.
3. End Plates shall meet the requirements of ASTM A-36.
4. Entire assembly shall be Hot-Dip Galvanized in accordance with ASTM A-123.

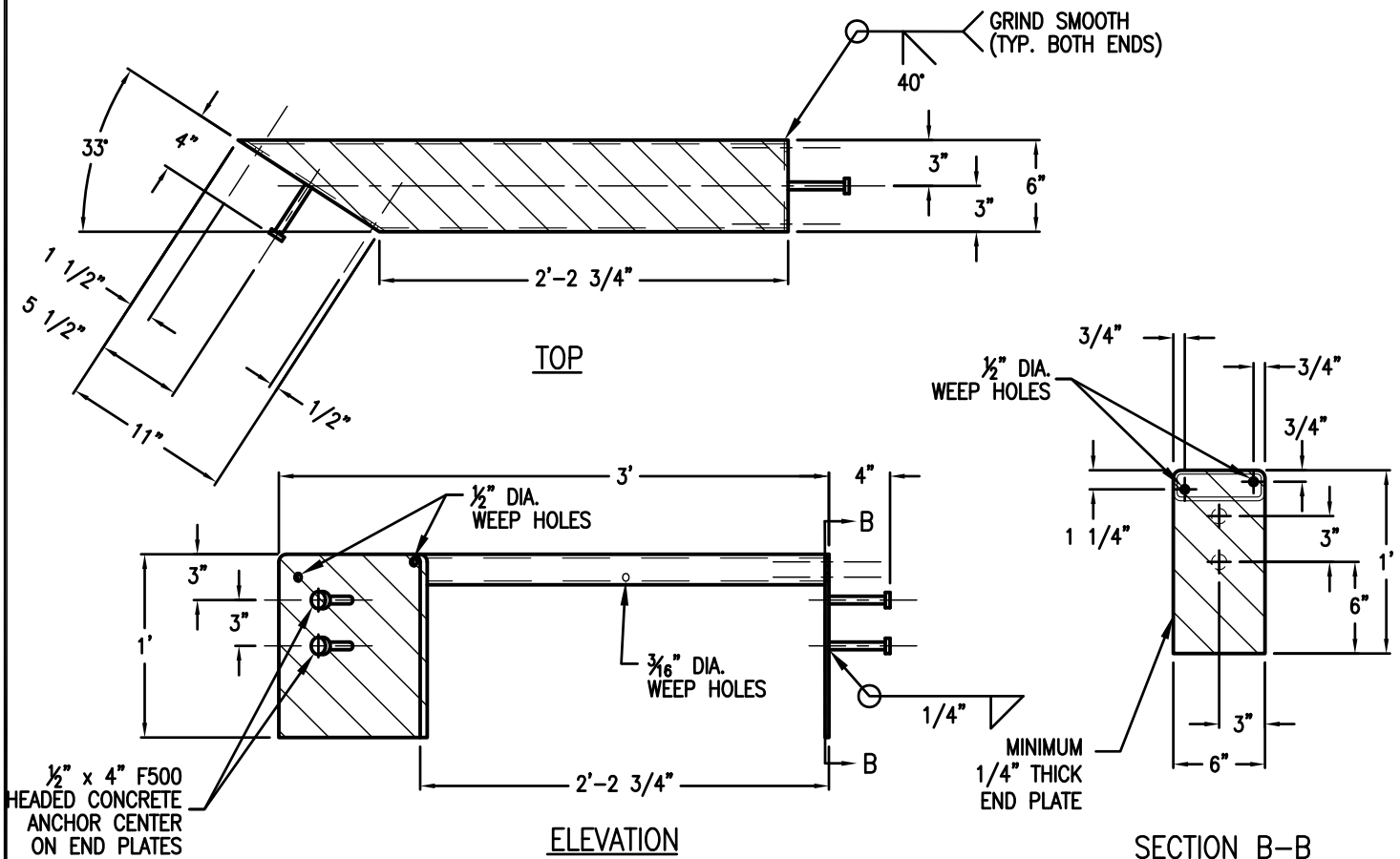

- DRAWING NOT TO SCALE -

STORMWATER MANAGEMENT MANUAL TYPICAL DETAILS



Bureau of Environmental Services

- Green Streets -
Modified Metal Inlet Assembly
Curb Inlets



NUMBER

SW-334

7-1-2016

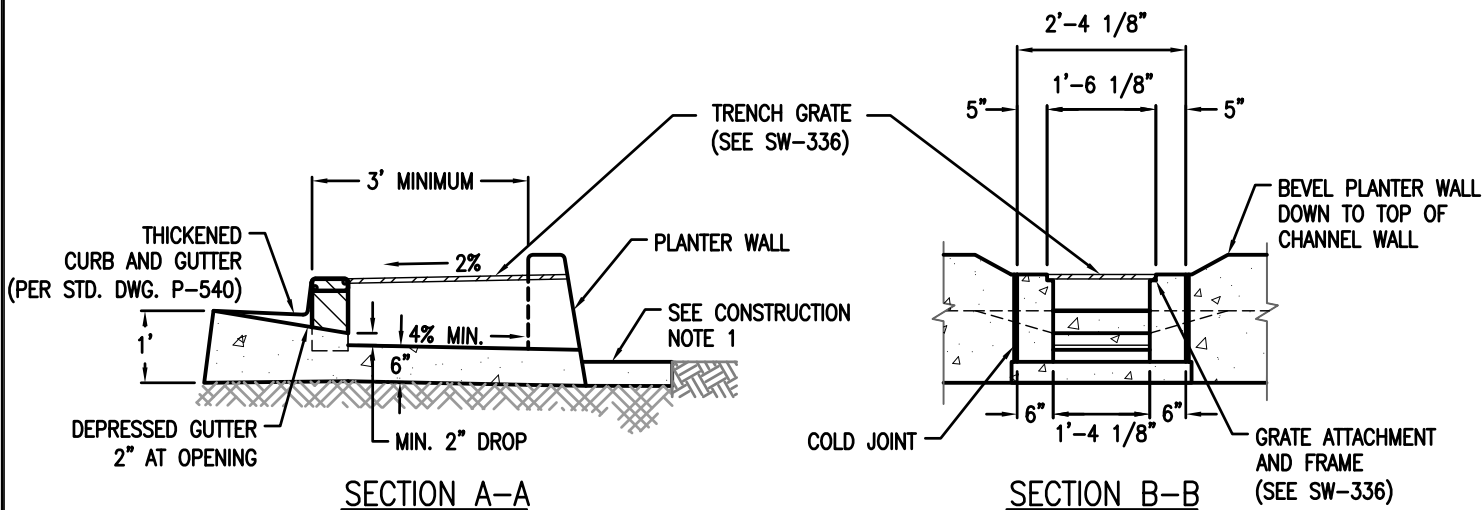
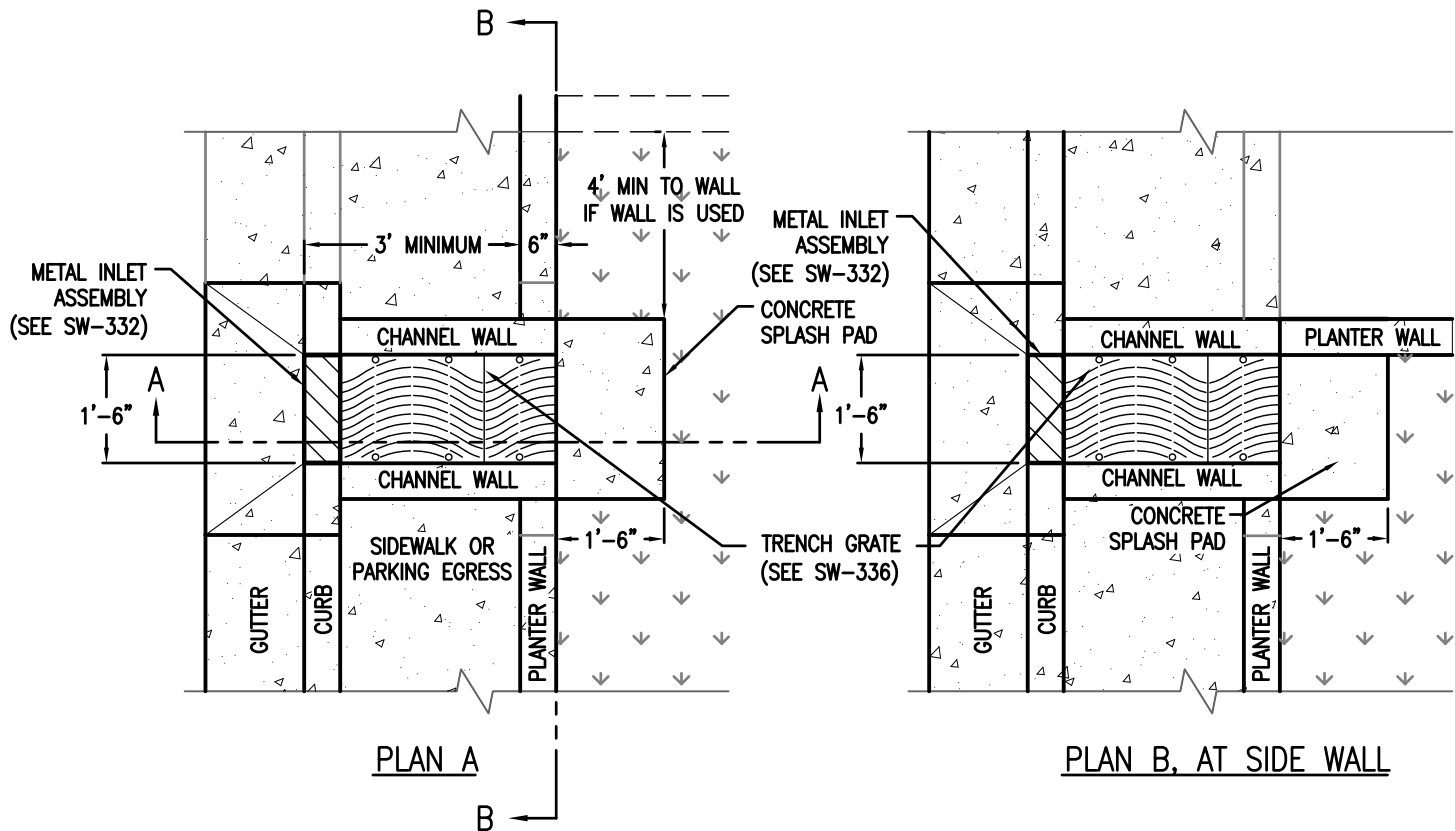

DESIGNER NOTES:

1. Inlet channel slope may vary where appropriate. Steeper slopes are better for keeping inlet free of debris.

CONSTRUCTION NOTES:

1. 4" thick concrete splash pad elevation shall be level with soil inside planter.
2. Concrete splash pad shall be 6" wider than channel opening on both sides.

- DRAWING NOT TO SCALE -

STORMWATER MANAGEMENT MANUAL TYPICAL DETAILS



Bureau of Environmental Services

- Green Streets -
Channel & Grate Details
Curb Inlets



NUMBER

SW-335A

7-1-2016

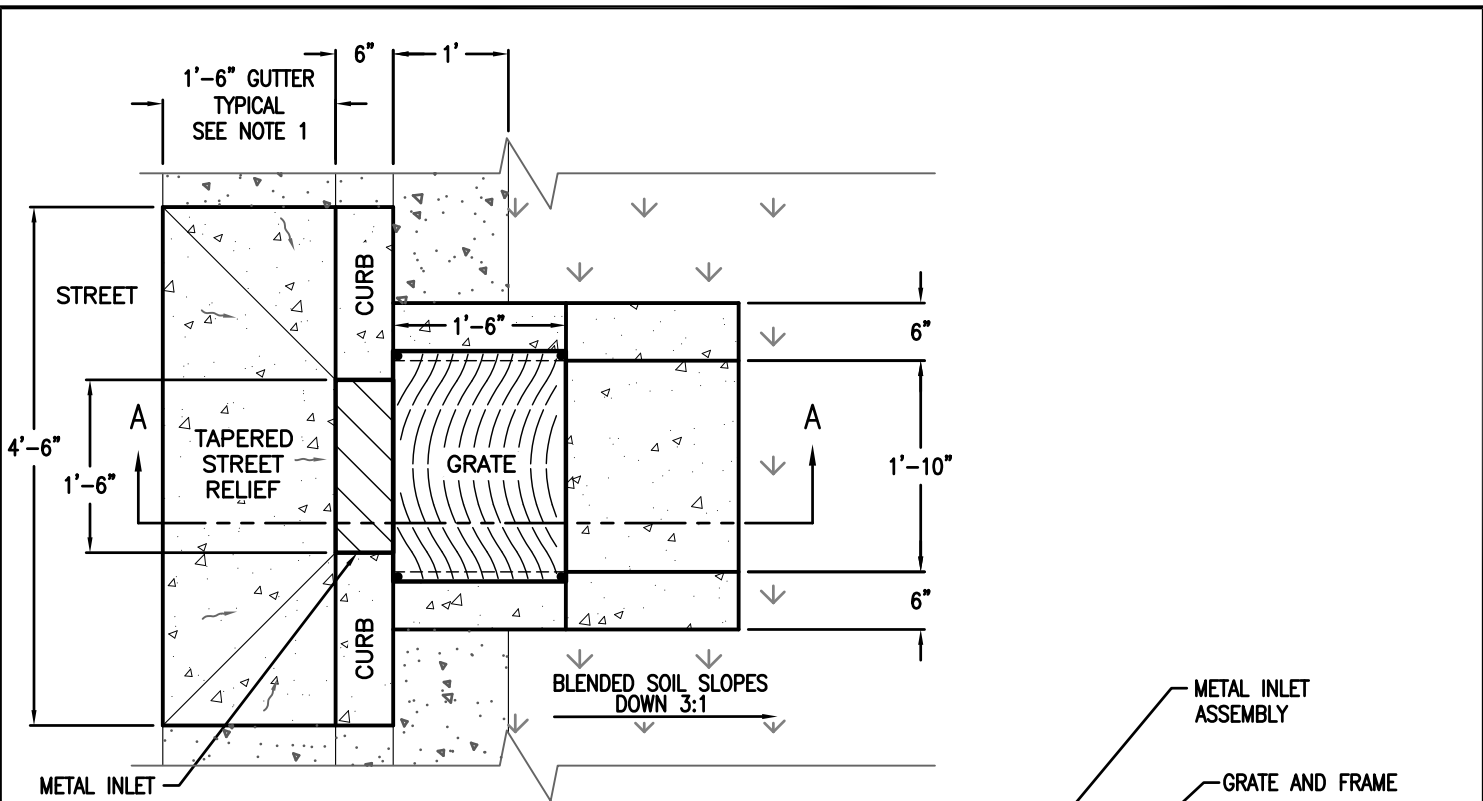

PLAN VIEW

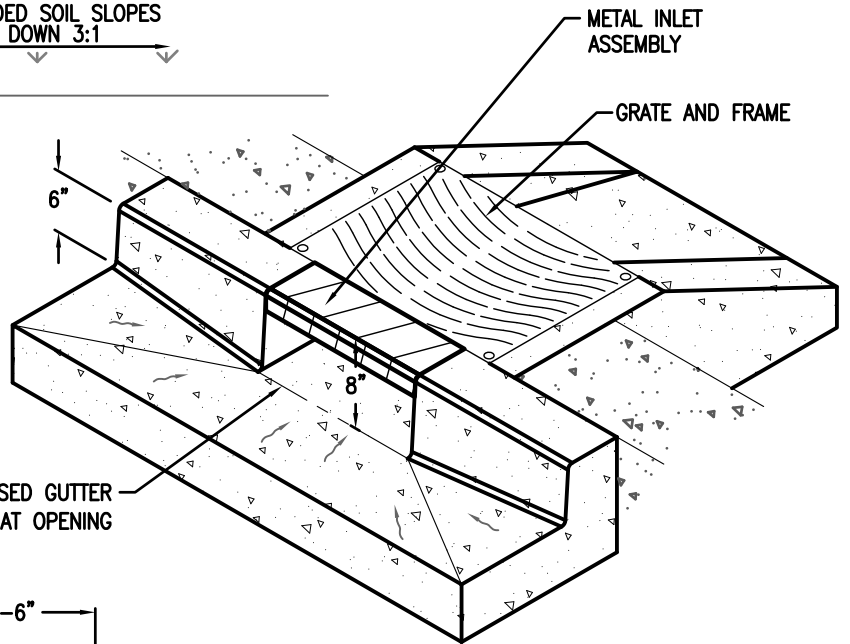

ISOMETRIC

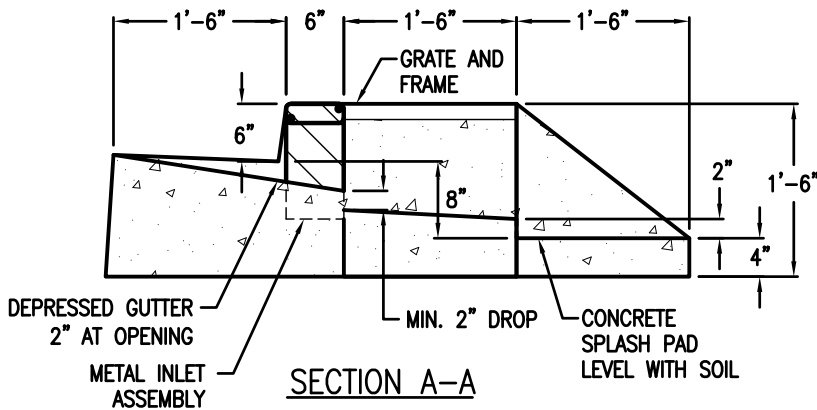

SECTION A-A

CONSTRUCTION NOTES:

- 1. Reference Standard Drawing P-540.

DESIGNER INFORMATION:

- 1. If Inlet used with swale stormwater facility modify plan and isometric views

- DRAWING NOT TO SCALE -

STORMWATER MANAGEMENT MANUAL TYPICAL DETAILS



Bureau of Environmental Services

- Green Streets -
 Inlet, Channel & Grate Details (Step-Out)
 Curb Inlets



NUMBER

SW-335B

7-1-2016

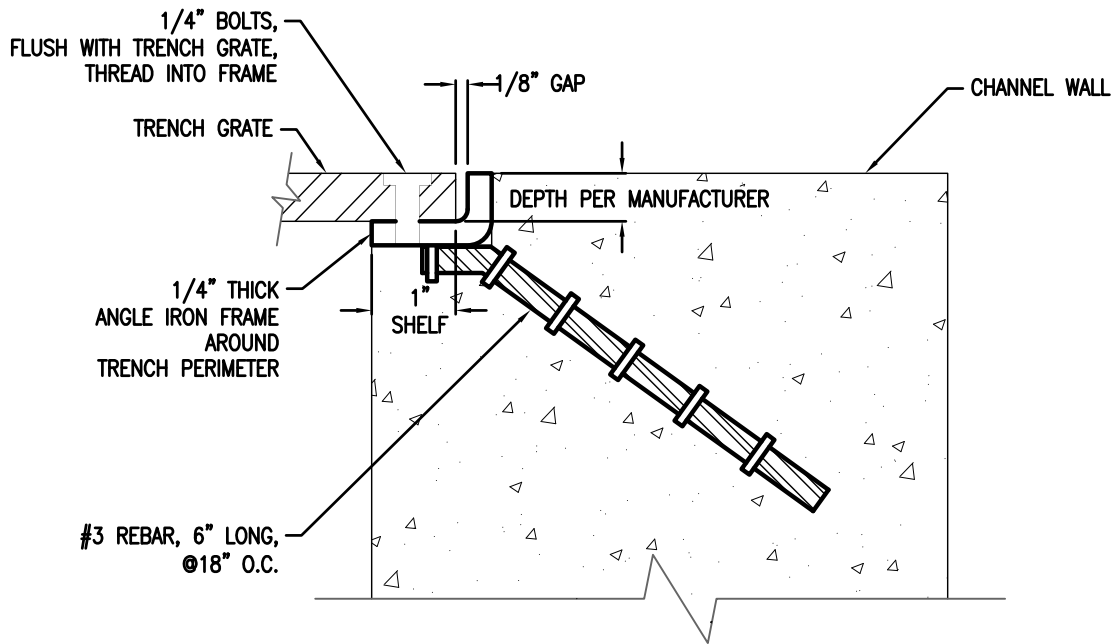

FRAME AND GRATE ATTACHMENT DETAIL

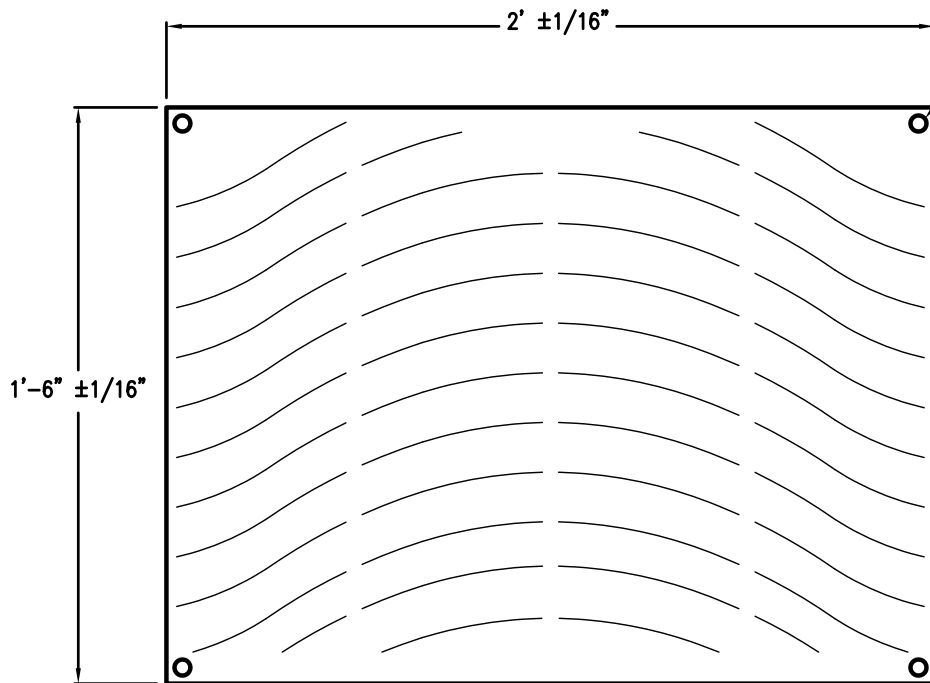

(4) 1/4" TAMPER-RESISTANT BOLTS PER GRATE, SEE GRATE ATTACHMENT DETAIL ABOVE

CONSTRUCTION NOTES:

1. Cast iron, natural finish.
2. No opening greater than 3/8".
3. Protect threaded holes in frame from clogging during frame installation.
4. Grate to be rated for H-20 loading, with a non-slip surface having a static coefficient of friction between 0.60 and 1.0 per ASTM C1020. Grates on inclines greater than 4% shall have a coefficient of 0.80 to 1.0.
5. Grate to be ADA compliant.

TRENCH GRATE

- DRAWING NOT TO SCALE -

STORMWATER MANAGEMENT MANUAL TYPICAL DETAILS

- Green Streets -

Grate & Frame Details
Check Dams



Bureau of Environmental Services



NUMBER

SW-336

7-1-2016

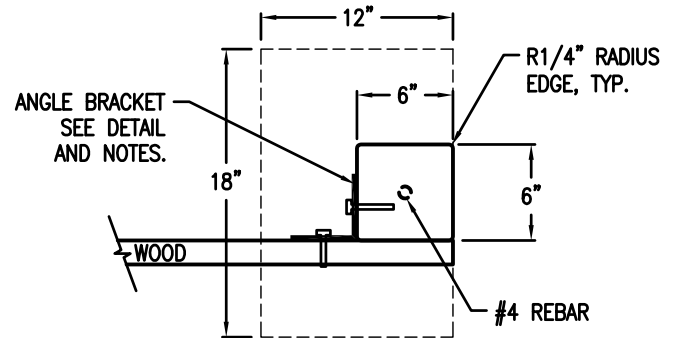
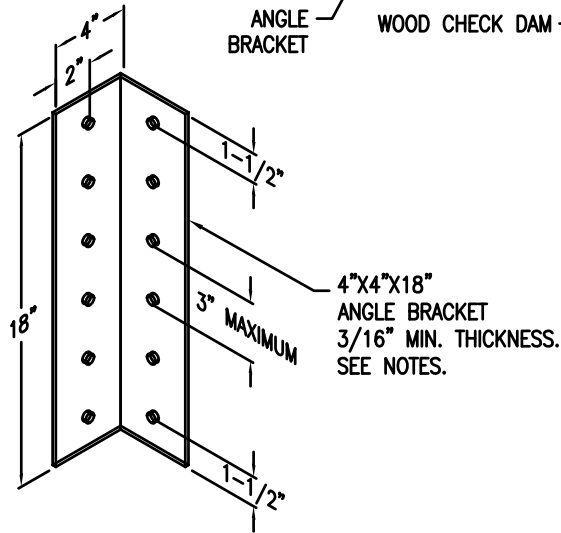
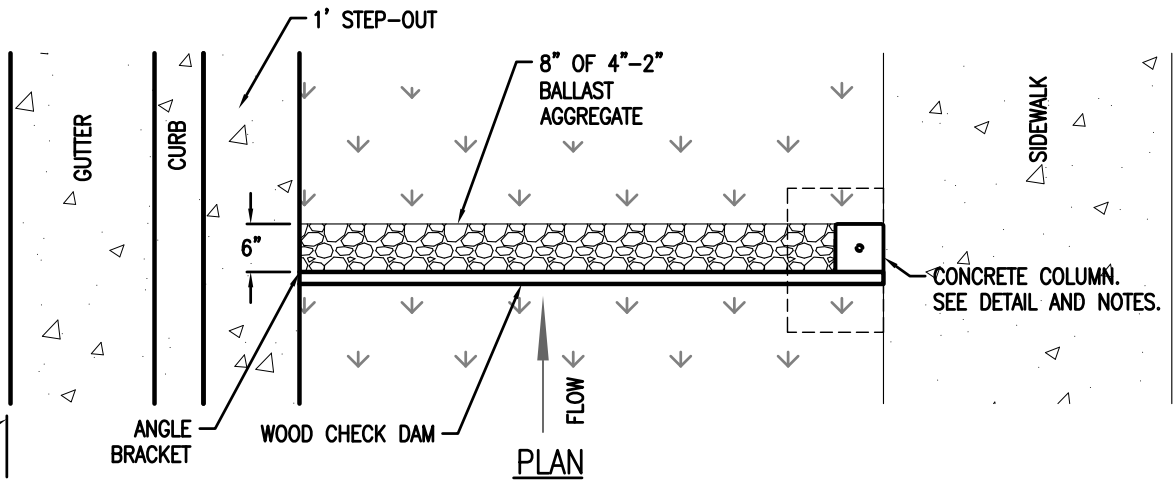
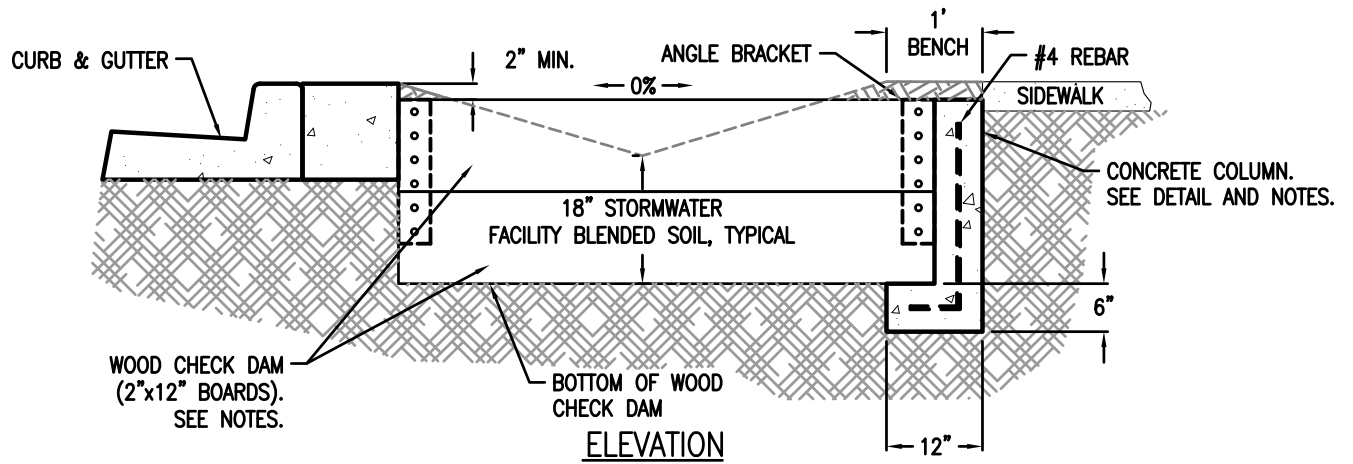

CONSTRUCTION NOTES

1. Concrete to be 3000 psi.
2. Lumber to be a naturally rot-resistant wood (e.g. cedar). Manufactured products can be used with approval. No chemically treated wood will be allowed. Boards shall be free from holes or loose knots and cut to fit width of facility without gaps.
3. All fasteners and bracket to be stainless steel or aluminum.
4. Top of bracket to be no higher than top of check dam.
5. Minimum 5/16" dia. bolts, 3 bolts/bracket into concrete and 4 bolts/bracket into wood (2 bolts into each board).
6. Use clear silicone caulk or other approved product between check dam boards and along brackets as watertight seal.

ANGLE BRACKET DETAIL

DESIGNER INFORMATION

1. Provide elevations and stationing and/or dimensioning for check dams, where applicable.
2. Ensure that check dam elevations do not cause stormwater to overflow to sidewalk or back in roadway.

- DRAWING NOT TO SCALE -

STORMWATER MANAGEMENT MANUAL TYPICAL DETAILS



Bureau of Environmental Services

- Green Streets -
Wood Check Dam for Swales
Check Dams



NUMBER

SW-341

7-1-2016

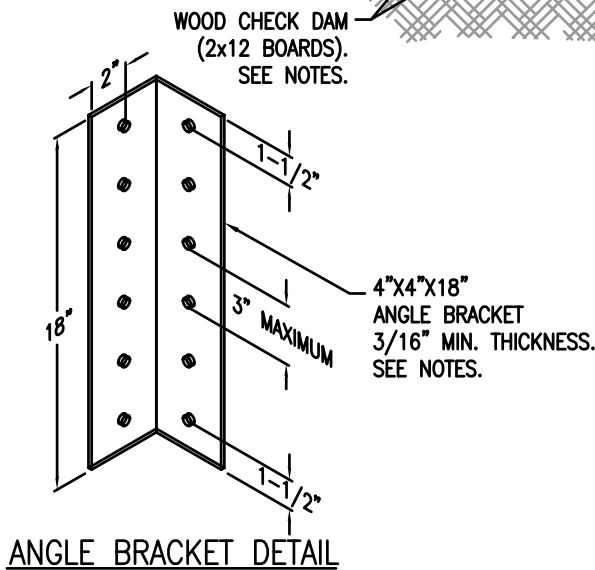
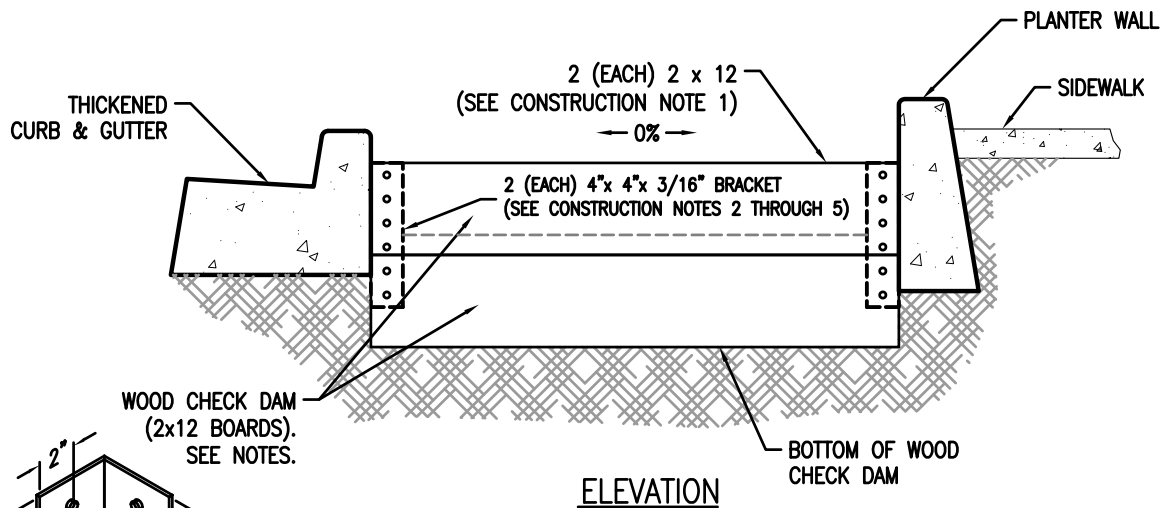
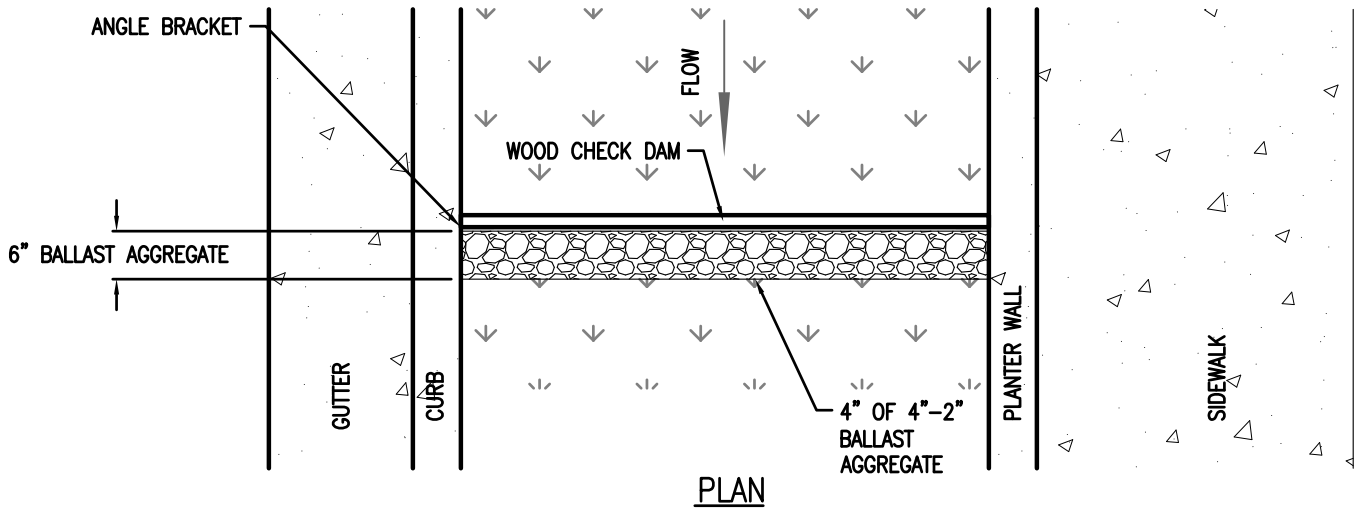

DESIGNER INFORMATION

1. Provide elevations and stationing and/or dimensioning for check dams.
2. Top of checkdam (tcd) elevation to be whichever is lowest: 1" below the elevation of the upstream inlet elevation of the facility; 2" below the elevation of the sidewalk adjacent to the check dam; or 2" below the elevation of the top of curb (toc) adjacent to the check dam.
3. Ensure that check dam elevations do not cause stormwater to overflow to sidewalk.
4. Provide 1' curb-side step-out if planter is adjacent to parking, modify detail as needed.

CONSTRUCTION NOTES

1. Lumber to be a naturally rot-resistant wood (e.g. cedar). Manufactured products can be used with approval. No chemically treated wood will be allowed.
2. All fasteners to be stainless steel or aluminum.
3. 4"x 4"x 18" angle bracket, minimum 3/16" thick, stainless steel, or aluminum.
4. Top of bracket to be no higher than top of check dam.
5. Minimum 5/16" dia. bolts, 3 bolts into concrete, 2 bolts into each board

- DRAWING NOT TO SCALE -

STORMWATER MANAGEMENT MANUAL TYPICAL DETAILS

- Green Streets -

Wood Check Dam for Planters
Check Dams



Bureau of Environmental Services



NUMBER

SW-342

7-1-2016

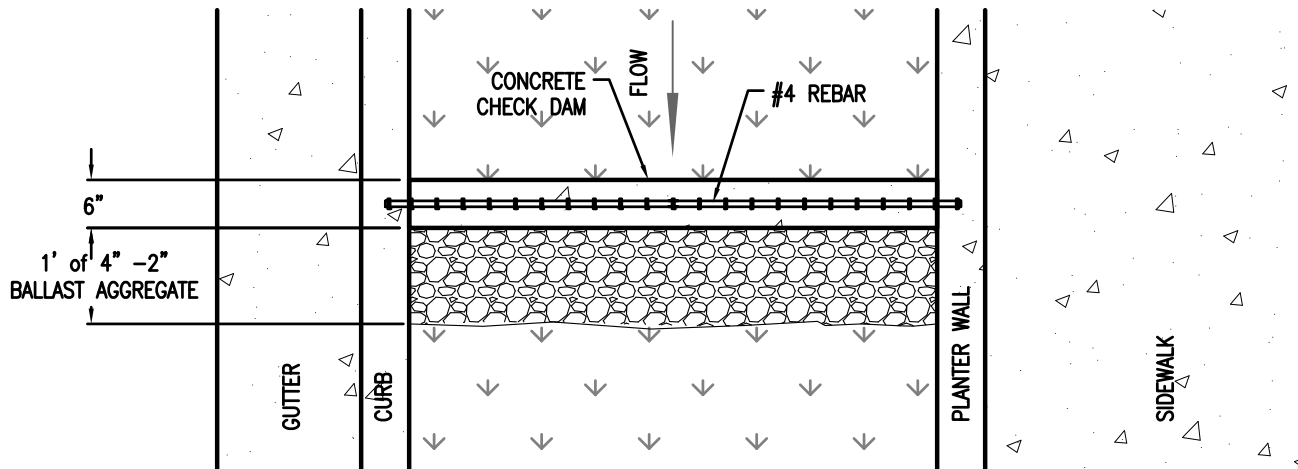

PLAN

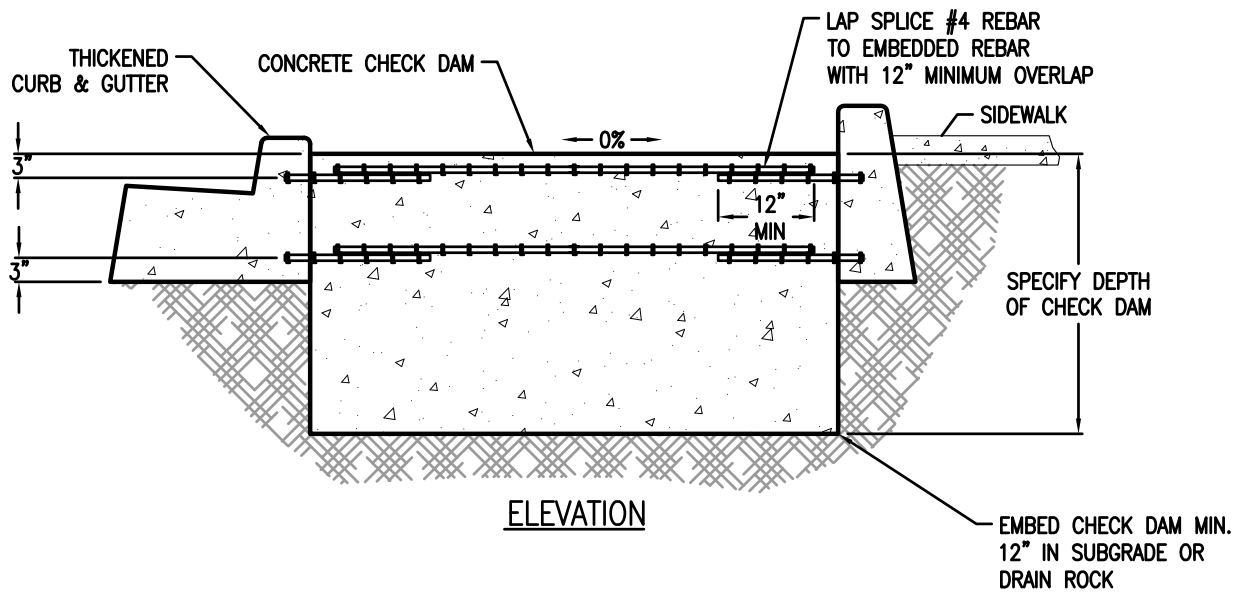

ELEVATION

DESIGNER INFORMATION

1. Provide elevations and stationing and/or dimensioning for check dams.
2. Top of checkdam (tcd) elevation to be whichever is lowest: 1" below the elevation of the upstream inlet elevation of the facility; 2" below the elevation of the sidewalk adjacent to the check dam; or 2" below the elevation of the top of curb (toc) adjacent to the check dam.
3. Ensure that check dam elevations do not cause stormwater to overflow to sidewalk.
4. Provide 1' curb-side step-out if planter is adjacent to parking, modify detail as needed.

CONSTRUCTION NOTE

1. Concrete to be 3,000 psi.
2. Embed #4 rebar 3" into curb and planter wall.

- DRAWING NOT TO SCALE -

STORMWATER MANAGEMENT MANUAL TYPICAL DETAILS

- Green Streets -

Concrete Check Dam for Planters
Check Dams



Bureau of Environmental Services



NUMBER

SW-343

7-1-2016

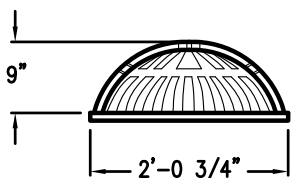
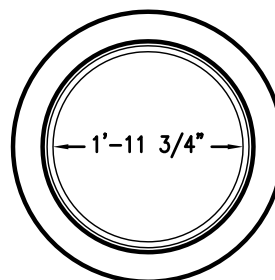
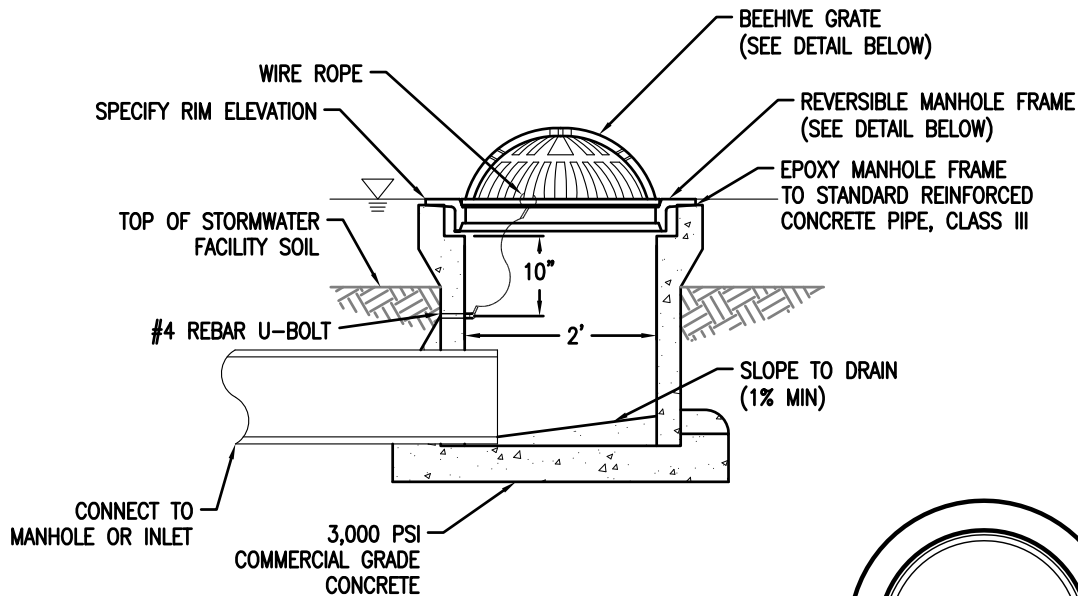

BEEHIVE GRATE

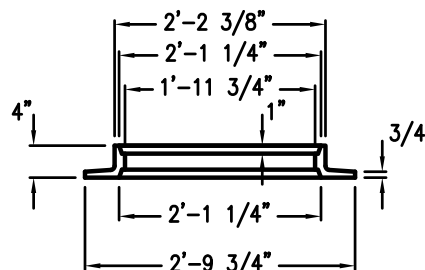

24"x4" REVERSIBLE MANHOLE FRAME

DESIGNER INFORMATION

1. If connecting to a combination sewer manhole installation of a "swing-check type backwater valve" or approved equal is required to prevent odor emissions.
2. Size inlet based on calculated flows & manufacturers recommendations.

CONSTRUCTION NOTES

1. Secure grate in place with 54" of wire rope. Loop ends of wire rope around U-bolt and grate. Crimp each end of wire rope with ferrule.
2. Drill 2" deep holes into pipe and epoxy #4 rebar U-bolt (2"x 4") in holes.
3. Grate to be cast iron, ASTM A48 CL30.
4. Beehive rim elevation to be 1" lower than sidewalk notches, top of planter wall, top of slope, outlet 'notch or upstream notch, whichever is lowest.
5. Wire rope between 1/8"-3/16" diameter, stainless steel, 7 strands of 19 wires.

- DRAWING NOT TO SCALE -

STORMWATER MANAGEMENT MANUAL TYPICAL DETAILS



Bureau of Environmental Services

- Green Streets -
Beehive Inlet Grate
Overflow Inlets



NUMBER

SW-350

7-1-2016

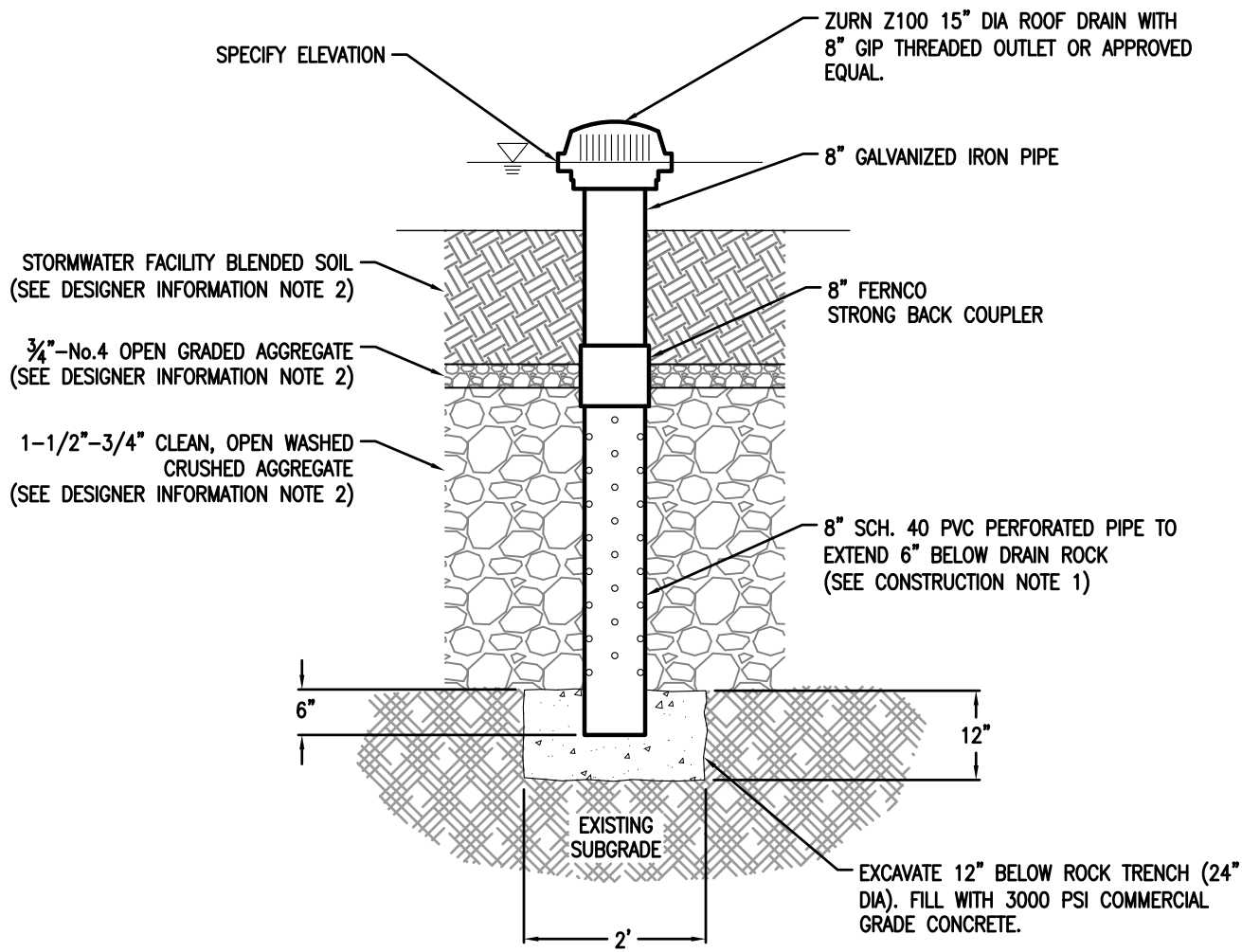

DESIGNER INFORMATION

1. Show overflow drain in swale, planter or curb extension section. Separate swale, planter or curb extension section views may not be needed.
2. Dimension stormwater facility blended soil and rock layers per your design.

CONSTRUCTION NOTE

1. Perforate 8" Schedule 40 PVC with 1/2" holes, 90 degrees around pipe, rows 2" apart. Offset holes in rows by 45'.

- DRAWING NOT TO SCALE -

STORMWATER MANAGEMENT MANUAL TYPICAL DETAILS



Bureau of Environmental Services

- Green Streets -
 Overflow Drain
 Overflow Inlets



NUMBER

SW-351

7-1-2016

CONSTRUCTION NOTES

1. Adhere liner to concrete w/sealant recommended by liner manufacture.
2. Secure liner to concrete with 2" aluminum flat bar, placed as directed (curb side or entire facility).
3. Attach flat bar with concrete hit anchors, 24" o.c.
4. Trim excess liner to the top of the flat bar.
5. On clean concrete surface, add silicone sealer to top 1/2" of liner.
6. Start attaching liner in the middle of the facility first. Working toward the ends to minimize wrinkles, corners should be cut to fit without wrinkles.

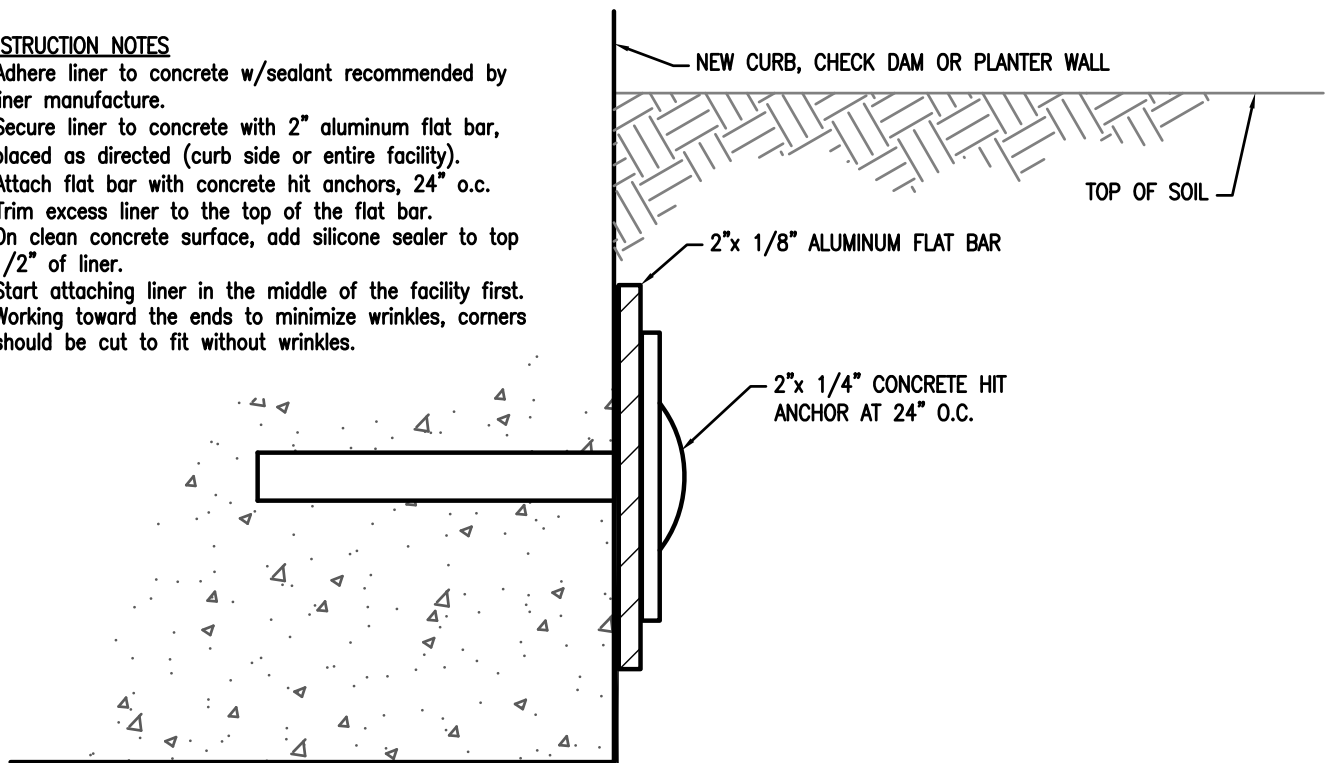

LINER ATTACHMENT

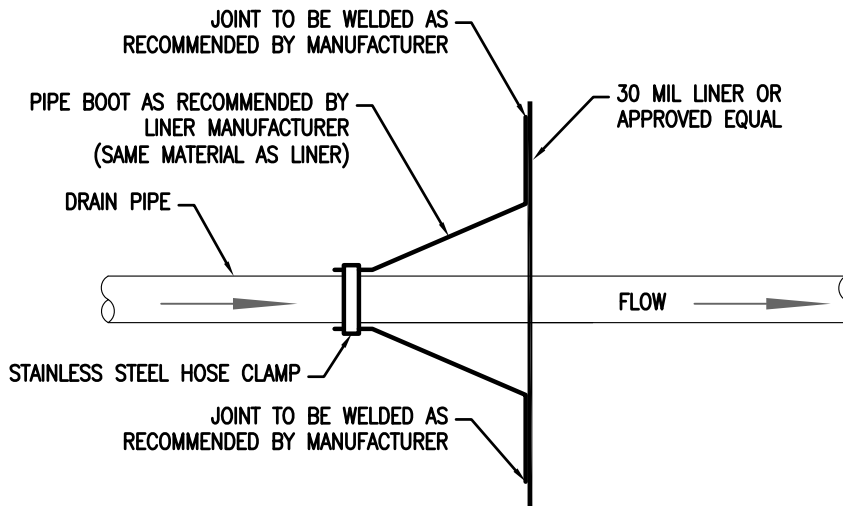

PIPE BOOT

DESIGNER INFORMATION

1. Liner materials to be HDPE. Liner to extend from top of blended soil to the bottom of excavation.
2. 3" of concrete is required on all sides of attachment. Adjust sidewalk depth as necessary.
3. Liner required when face of new curb is less than 2' from OD of adjacent water main.
4. Liner required on neighborhood collectors and higher street classifications.
5. Liner may be required on local streets with transit routes, higher traffic volumes, or when a facility is adjacent to travel lane at the discretion of the City Engineer.
6. In the Columbia South Shore Well Field Wellhead Protection Area or areas with contaminated soils the facility must be completely lined with a 40 mil liner unless facility's bottom and sides are monolithic concrete.
7. Liners may be required near basements or other underground structures.
8. Trees allowed in lined facilities only at the discretion of City of Portland staff.

- DRAWING NOT TO SCALE -

STORMWATER MANAGEMENT MANUAL TYPICAL DETAILS



Bureau of Environmental Services

- Green Streets -
Liner Attachment & Pipe Boot Detail
Additional Details



NUMBER

SW-360

7-1-2016

DESIGNER INFORMATION:

1. Refer to Standard Drawing P-581 for tree planting instructions.
2. Distance between trees varies: 20ft-30ft on center per Urban Forestry requirements.
3. Stormwater facility construction and blended soil requirements, see City of Portland Standard Construction Specifications sections 00415 and 01040.14(d).
4. All proposed tree species must be approved by Urban Forestry (503-823-8733).
5. Include Tree Well and Street Tree views on plans.
6. Include liner and call-out if used, see Swale Section SW-301.
7. Trees shall be centered in the planting zone/tree well.
8. Planting zone/tree well shall be located to align new tree trunk with street trees in adjacent planting strip, unless otherwise shown on plan and approved by BES and Urban Forestry.

CONSTRUCTION NOTES:

1. Contact Urban Forestry for tree installation assistance and permitting at (503) 823-8733.
2. To the maximum extent possible set root ball on "pedestal" of native/undisturbed soil to avoid settling.
3. Set trunk flare two inches above the finished soil surface.
4. Remove all twine, wire, root bags, burlap, and all other nursery materials from tree prior to backfilling.

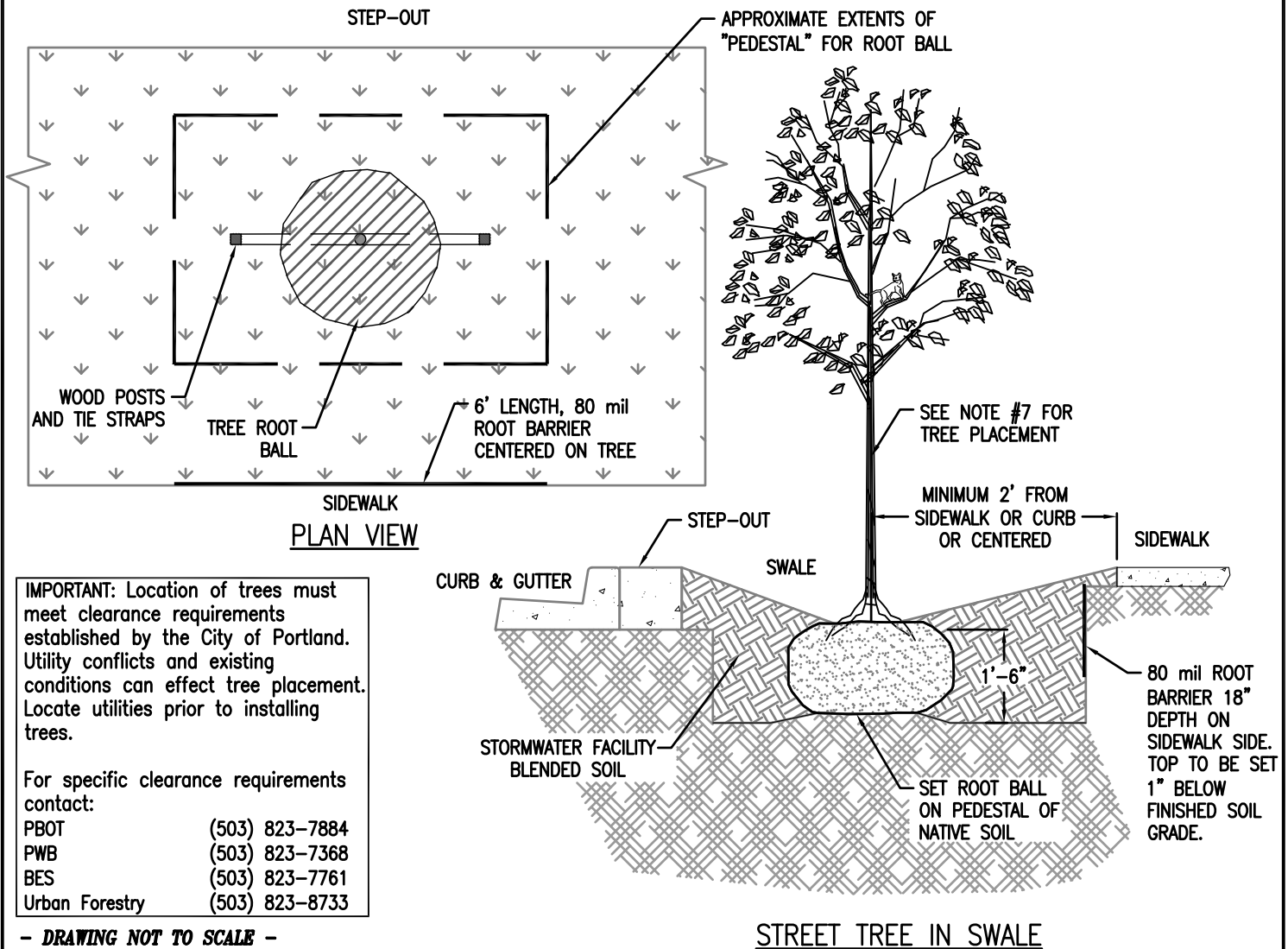

IMPORTANT: Location of trees must meet clearance requirements established by the City of Portland. Utility conflicts and existing conditions can effect tree placement. Locate utilities prior to installing trees.

For specific clearance requirements contact:

PBOT	(503) 823-7884
PWB	(503) 823-7368
BES	(503) 823-7761
Urban Forestry	(503) 823-8733

- DRAWING NOT TO SCALE -

STORMWATER MANAGEMENT MANUAL TYPICAL DETAILS

- Green Streets -
Tree Well Detail
 Without Rock Storage



Bureau of Environmental Services



NUMBER
SW-361
 7-1-2016

DESIGNER INFORMATION:

1. Refer to Standard Drawing P-581 for tree planting instructions.
2. Distance between trees varies: 20ft-30ft on center per Urban Forestry requirements.
3. Stormwater facility construction and blended soil requirements, see City of Portland Standard Construction Specifications sections 00415 and 01040.14(d).
4. All proposed tree species must be approved by Urban Forestry (503-823-8733).
5. Include Tree Well and Street Tree views on plans.
6. Include liner and call-out if used, see Swale Section SW-301.
7. Trees shall be centered in the planting zone/tree well.
8. Planting zone/tree well shall be located to align new tree trunk with street trees in adjacent planting strip, unless otherwise shown on plan and approved by BES and Urban Forestry.
9. Tree well required when tree is located over rock storage.

CONSTRUCTION NOTES:

1. Contact Urban Forestry for tree installation assistance and permitting at (503) 823-8733.
2. Set trunk flare two inches above soil surface.
3. Remove all twine, wire, root bags, burlap, and all other nursery materials from tree prior to backfilling.

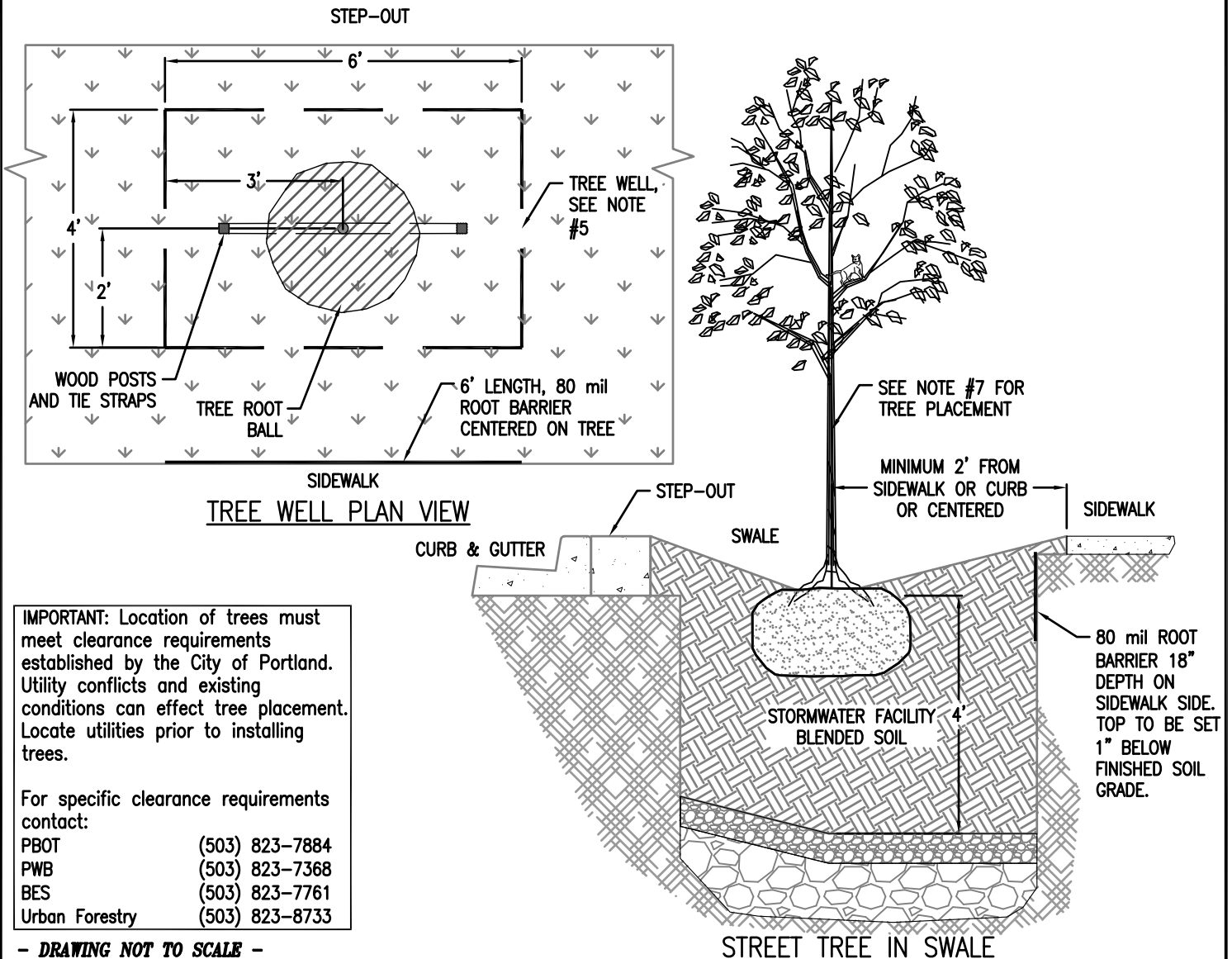

IMPORTANT: Location of trees must meet clearance requirements established by the City of Portland. Utility conflicts and existing conditions can effect tree placement. Locate utilities prior to installing trees.

For specific clearance requirements contact:

PBOT	(503) 823-7884
PWB	(503) 823-7368
BES	(503) 823-7761
Urban Forestry	(503) 823-8733

- DRAWING NOT TO SCALE -

STORMWATER MANAGEMENT MANUAL TYPICAL DETAILS

- Green Streets -
Tree Well Detail
With Rock Storage



Bureau of Environmental Services



NUMBER

SW-362

7-1-2016

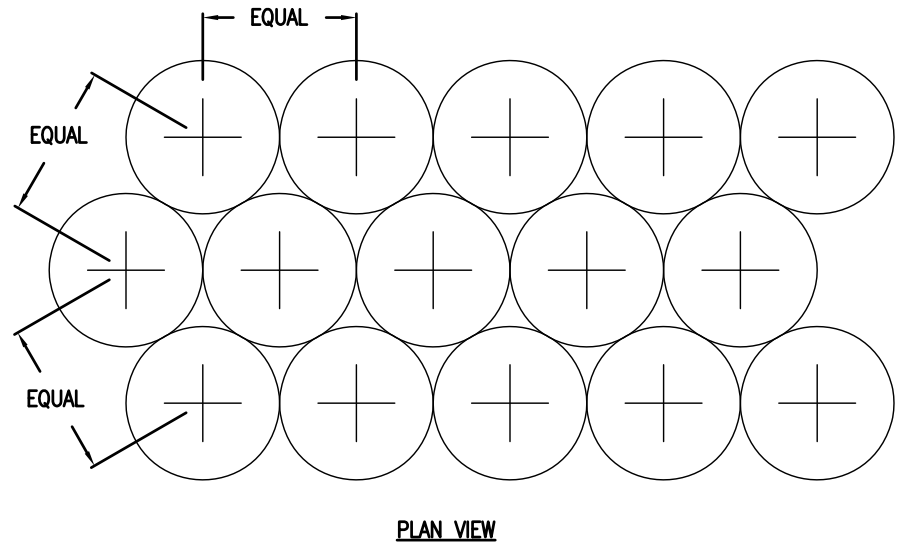
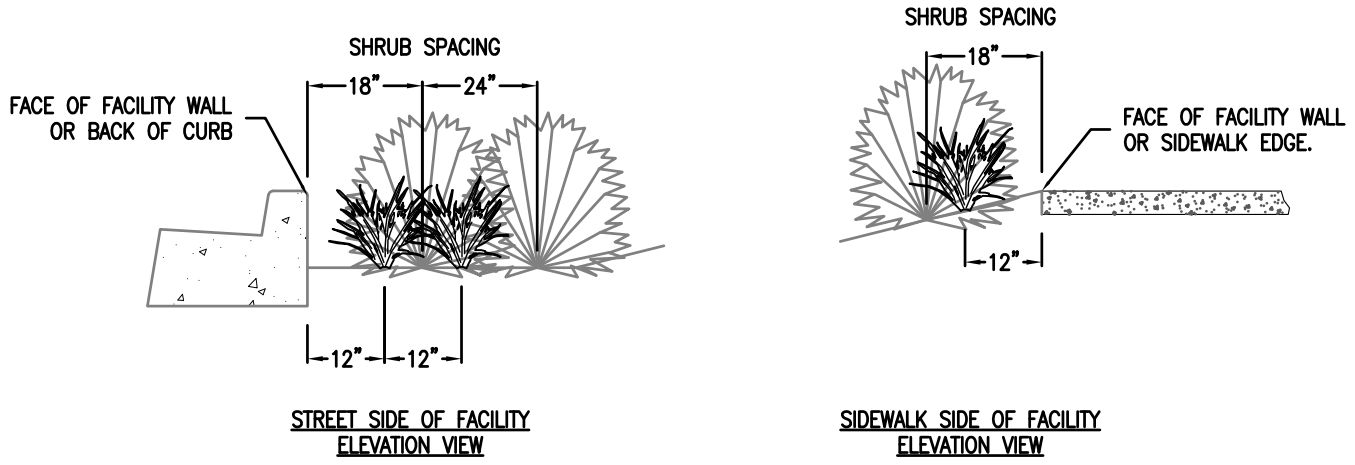

HERBACEOUS AND GROUNDCOVER SPACING

DESIGNER INSTRUCTIONS

1. All plants shall be planted at equal triangular spacing on center (O.C.) per spacing specified on the planting legend.
2. Plants shall be located set back from facility edges as follows:
 - a. Herbaceous plants and groundcovers: 12" from center of plant to face of facility wall, back of curb or sidewalk edge.
 - b. Shrubs: 18" from center of plant to face of facility wall, back of curb or sidewalk edge.
3. Interior plant spacing may be slightly adjusted to achieve desired edge setbacks.

- DRAWING NOT TO SCALE -

STORMWATER MANAGEMENT MANUAL TYPICAL DETAILS



Bureau of Environmental Services

- Green Streets -
Herbaceous Plants, Groundcovers & Shrubs
Plant Spacing



NUMBER
SW-363
7-1-2016

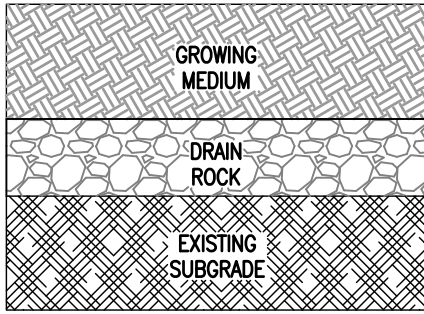

INFILTRATION
STORMWATER HIERARCHY CATEGORY 1

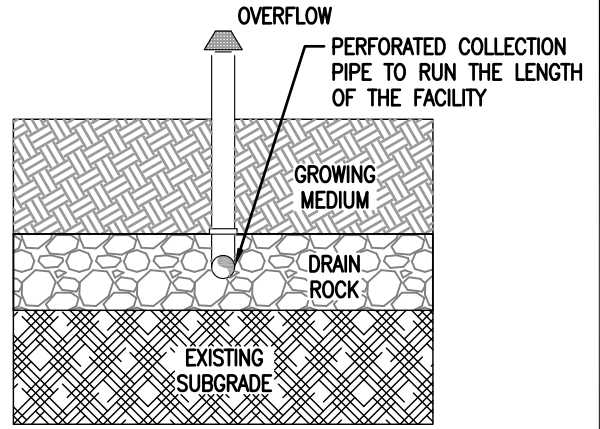

HYBRID
STORMWATER HIERARCHY CATEGORY 2
OVERFLOW DIRECTED TO DRAIN ROCK.

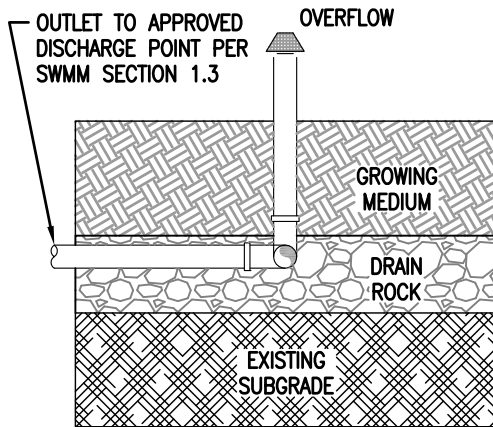

PARTIAL INFILTRATION
STORMWATER HIERARCHY CATEGORY 3 or 4
OVERFLOW AND UNDERDRAIN REQUIRED.
SET UNDERDRAIN WITHIN DRAIN ROCK

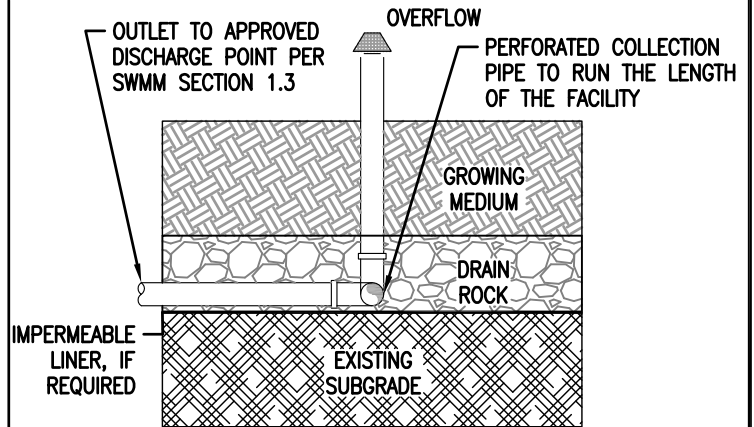

LINED
STORMWATER HIERARCHY CATEGORY 3 or 4
OVERFLOW AND UNDERDRAIN REQUIRED.
SET UNDERDRAIN AT BASE OF DRAIN ROCK LINER.

NOTE: Hybrid facilities must be registered as a UIC designed under the presumptive approach.

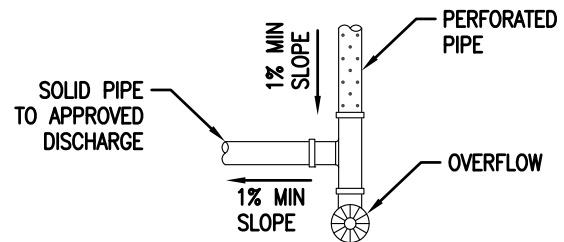

PLAN VIEW
PIPE W/ UNDERDRAIN & DISCHARGE POINT

- DRAWING NOT TO SCALE -

STORMWATER MANAGEMENT MANUAL TYPICAL DETAILS

- Green Streets -
Facility Overflow Configurations



Bureau of Environmental Services



NUMBER

SW-364

7-1-2016

2.3.6 Infiltration and Soil Requirements

This section presents information about depth to groundwater investigations, infiltration testing, and the specification for the blended soil used in vegetated stormwater facilities.

Depth to Groundwater Investigation

Several areas within the City of Portland have known shallow groundwater. Within areas of known or suspected shallow groundwater, additional information about the depth to groundwater (DTW) may be required to ensure that a proposed underground injection control (UIC) system meets minimum separation distances between the bottom of a UIC and seasonal high groundwater. Minimum separation distances are required by Oregon Department of Environmental Quality (DEQ) under UIC requirements. The minimum separation distance between the bottom of the UIC and seasonal high groundwater is 5 feet.

When a public or private UIC is proposed within areas of known or suspected shallow groundwater, a site specific investigation may be required to determine the seasonal high depth to groundwater. A DTW investigation may be required for areas where the estimated depth to seasonal high groundwater is estimated to be less than 50 feet of ground surface. To identify areas of shallow groundwater within the City please consult the map which the City of Portland derived from the [Estimation of Depth to Ground Water and Configuration of the Water Table in the Portland, Oregon Area](#), prepared by the United States Geological Survey (USGS). This map is available online in two locations:

- Through www.PortlandMaps.com.
- Through USGS mapping at http://or.water.usgs.gov/projs_dir/puz/.

Depth to Groundwater Investigation Requirements

The DTW investigation requires sufficient time to plan for and perform the necessary steps to collect a reliable measurement, including obtaining permits, performing utility locates, borings, piezometer/well installation, collection of water level measurements, and decommissioning of the monitoring well. The DTW investigation, including design, installation oversight, water measurements, and decommissioning, must be performed by an Oregon licensed registered geologist (RG), certified engineering geologist (CEG), or professional engineer (PE) with experience in hydrogeologic investigations and well design and installation; the investigation may include either the installation of a temporary piezometer(s) or

groundwater monitoring well(s). The qualified professional is responsible for developing an appropriate scope of work to document the DTW, including:

- Determining the number and location(s) of the DTW measurements needed to address project objectives. It is recommended, but not required, to have each piezometer or well location surveyed to a datum.
- Determining the appropriate method for obtaining DTW measurements (e.g., piezometer or monitoring well).
- Determining the appropriate depth of the boring(s). Boring depth must be a minimum of 20 feet deeper than the proposed UIC depth.
- Observing and describing soils encountered during drilling.
- Developing an appropriate well or piezometer design.
- Ensuring that construction and abandonment of piezometer or monitoring well complies with Oregon Administration Rules 690-240.
- Obtaining depth to groundwater measurements (see Figure 2-32 for an illustration of the process). If groundwater is not encountered (e.g. saturated conditions are not observed, no water seeps are observed) within 20 feet of the proposed bottom of the UIC, a piezometer or monitoring well does not need to be installed.
- Estimating the measured DTW to be representative of the “groundwater seasonal high,” based on available data and best professional judgment.
- Documenting the procedures used and the results of the DTW investigation.
- Submitting a signed and stamped DTW investigation report.

To the extent practicable, DTW measurements should be obtained in the immediate vicinity (less than or equal to 75 feet) of the proposed UIC. If high-quality shallow groundwater level data is available (e.g., piezometer, monitoring well, drinking water well, irrigation well) within 200 feet of the proposed UIC location, this data may be considered in lieu of site-specific data.

Figure 2-32. Depth to Groundwater Investigation

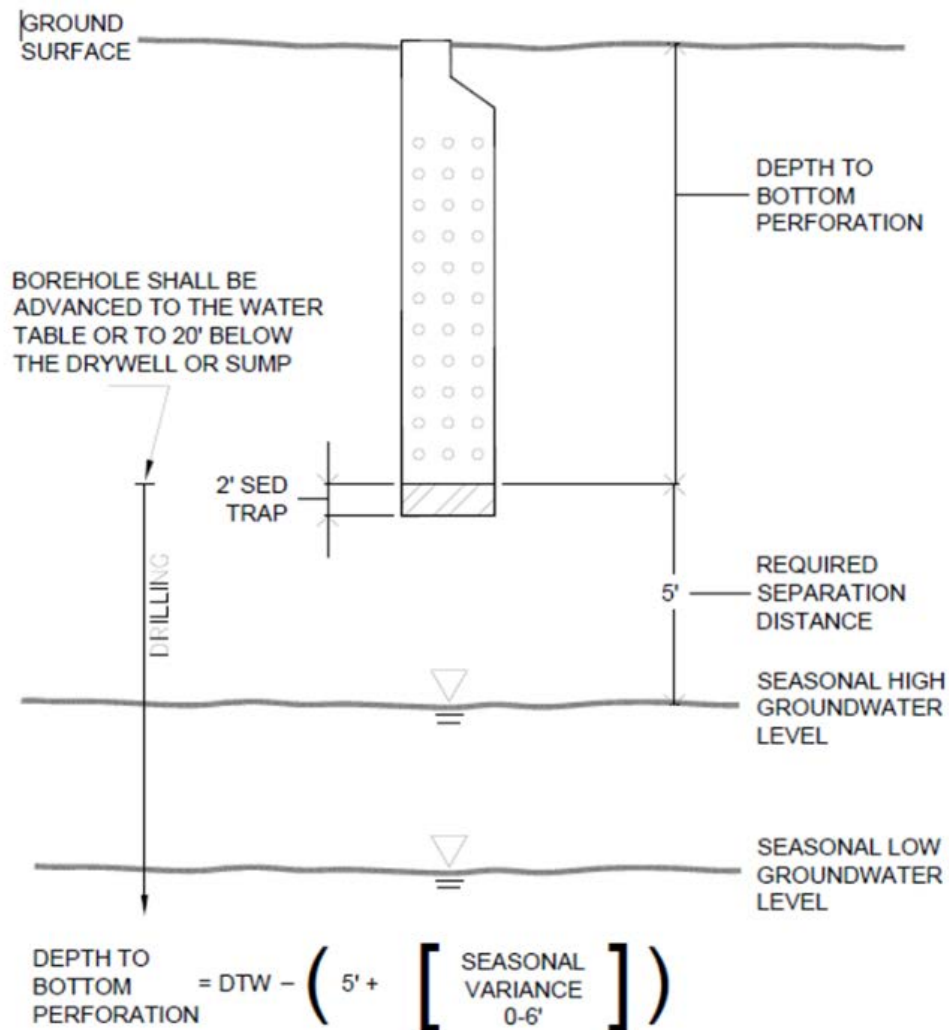

Piezometer/Well Borehole Drilling and Installation

Continuous soil sampling is recommended to allow detailed characterization of subsurface soil and identification of groundwater depth. The RG, CEG, or PE must prepare and submit a detailed boring log of subsurface conditions. Soil boring logs should be in accordance with the *Standard Practice for Description and Identification of Soils* (Visual-Manual Procedure) (ASTM D2488-00). Borings must be advanced to the groundwater level, or to a minimum of 20 feet below the proposed total depth of the UIC or 10 feet below a proposed UIC of 5 feet or less. If water is encountered in the boring, it must be noted on the drilling log.

The appropriate drilling method should be selected by the RG, CEG, or PE in conjunction with the driller, based on anticipated site-specific geologic and hydrogeologic conditions, anticipated boring depth, site accessibility, availability of equipment, and piezometer/well design. All equipment placed into the boreholes must be properly decontaminated prior to use.

Any investigation-derived material (e.g., soil cutting, water, personal protective gear) generated during drilling activities must be properly contained, characterized, and disposed in accordance with applicable state and federal regulations. Soil and water disposal must be documented.

Depth to Water Measurements

Following piezometer/well installation, water levels must be allowed to equilibrate for a minimum of 24 hours in fine-grained soils. After the water level has stabilized, an electronic water level indicator or a weighed tape should be used to measure the depth to water. Measurements should be made relative to ground surface and to the nearest 1/8 inch (~0.01 feet). The observer must make at a minimum two measurements over a period of about 15 minutes to show the results are static.

Estimating Depth to Seasonal High Groundwater

The site-specific DTW measurement must be used to estimate the depth to seasonal high groundwater. Seasonal water-table fluctuations were evaluated in the [*Estimation of Depth to Ground Water and Configuration of the Water Table in the Portland, Oregon Area*](#) report, prepared by the USGS and used to determine the seasonal correction factor (SCF). The SCF represents a long-term measurement of the seasonal water-table fluctuations. The SCF was set at 6 feet, using the USGS estimated mean of observed seasonal water table fluctuations for the unconsolidated sedimentary aquifer. To correct for seasonal variation, the SCF used to estimate depth to seasonal high groundwater is applied during periods of seasonal groundwater lows (late fall) and water level transition (summer and winter months). In March through May (seasonal high groundwater), no correction is added.

To correct site-specific DTW measurements to seasonal high DTW estimates, the following correction should be made:

$$DTW_{SH} = DTW_{SS} - SCF$$

Where:

- DTW_{SH} = Estimated seasonal high depth to groundwater (feet)
- DTW_{SS} = Measured site-specific depth to groundwater (time specific)
- SCF = Seasonal correction factor
 - 6 feet for measurements June through February
 - 0 feet for measurements in March through May

If water is not encountered in the soil boring, advanced 20 feet below the proposed UIC completion depth, it must be documented on the boring log and in the investigation report. In this case, the depth to water is assumed to be outside the range of seasonal fluctuation; the minimum required separation distance for the proposed bottom of the UIC to seasonal high groundwater is therefore met by default. The borehole may be decommissioned immediately, in accordance with OAR 690-240.

Decommissioning

Borings, piezometers, temporary wells, and wells must be abandoned in accordance with OAR 690-240. Specific decommissioning procedures must be determined by a licensed driller and the registered geologist or professional engineer.

Minimum Requirements for DTW Investigation Report

The DTW Investigation report must contain, but is not limited to:

- A copy of the State of Oregon Monitoring Well Log Report or Geotechnical Hole Report, as appropriate.
- A map showing the final location of each well or piezometer and tax lot boundaries.
- Latitude and longitude of each well or piezometer.
- Description of field procedures (drilling method, sampling method, development method, depth to groundwater measurements, etc.).
- Measured water level to the nearest hundredth of a foot.
- Detailed soils log prepared by, or under the direct supervision of, the RG, CEG, or PE.

- Construction diagram for each well/piezometer.
- Summary of groundwater depth measurements (depth measured, elevation, date, time).
- Discussion/basis for estimation of seasonal high depth to groundwater measurement.
- Construction and investigation reports stamped and signed by the RG, CEG, or PE.

Depth to Groundwater Investigation Report Submittal and Usage

Two copies of the OWRD well or piezometer construction report and the signed and stamped DTW investigation report must be submitted with the development permit application to the City and to DEQ with the UIC rule authorization application, which can be obtained at <http://www.deq.state.or.us/wq/uic/forms.htm>.

The corrected site-specific depth to seasonal high groundwater must be used to verify that the proposed UIC will meet the separation distances set by DEQ to obtain rule authorization for private UICs or ensure compliance under the City's WPCF permit. If separation distances cannot be met, an alternative design must be developed that meets separation distance requirements.

Infiltration Testing

To properly size and locate stormwater management facilities, it is necessary to characterize the soil infiltration conditions at the location of the proposed facility. All projects that propose onsite infiltration must evaluate existing site conditions and determine:

- If the infiltration rate is adequate to support the proposed stormwater management facility (satisfied through the Simplified Approach Infiltration Test), or
- The design infiltration rate prior to facility design (satisfied through Presumptive or Performance infiltration testing conducted by a qualified professional).

The following sections provide the approved standard infiltration testing specifications.

Minimum Number of Required Tests

The number of required infiltration tests may vary by type of development proposal or by design approach.

Land Division

- Two infiltration tests are required for a site up to 10,000 square feet in area.
- Each additional 10,000 square feet of site area requires an additional test.
- At least one test for any potential street facility.
- One test for every 100 lineal feet of infiltration facility.
- No more than five tests are required per development (at the discretion of the qualified professional assessing the site, as well as the City of Portland).

Tests performed for a proposed land division can be used at the building permit stage as long as the results of the test are submitted with the separate applications and were conducted within twenty-four months prior to the date the plans were submitted for review.

Building Permits

- The Simplified Approach requires one infiltration test for every proposed facility.
- The Presumptive and Performance Approaches require at least one test for any proposed street facility; require one test for every 100 lineal feet of proposed

infiltration facility; and the number of tests is at the discretion of the qualified professional assessing the site, as well as the City of Portland.

Where multiple types of facilities are used, it is likely that multiple tests will be necessary, since an infiltration test can test only a single location. It is highly recommended to conduct an infiltration test at each stratum used. BES staff may require additional testing. If additional testing is required during plan review, the applicant must provide 24-hour notice to BES staff and specify the time and location that the test will take place.

Simplified Approach Infiltration Test Requirements

The Simplified Approach provides a design approach that can be used by a nonprofessional for design of simple stormwater systems on small projects. This method, the Simplified Approach Infiltration Test, is applicable only to projects on private property with less than 10,000 square feet of new or redeveloped impervious area (see [Section 2.2.1](#)). The results of infiltration testing must be documented on the Simplified Approach Form (see [Section 2.4.3](#)).

On a site with steep slopes or shallow groundwater, BES may require a geotechnical report in order to evaluate the suitability of the proposed facility and its location. BES staff may also require an encased falling head or a double-ring infiltrometer infiltration test (see below for instructions) in order to verify that the facilities designed under the Simplified Approach are appropriate.

The Simplified Approach Infiltration Test cannot be used to find a design infiltration rate. The intent of the Simplified Approach Infiltration Test is to determine whether or not the local infiltration rate is adequate (2 inches/hour or greater) for the predesigned stormwater facilities described in [Section 2.3](#) (infiltration swales, basins, planters, drywells, and trenches). The Simplified Approach Infiltration Test does not need to be conducted by a licensed professional.

Simplified Approach Infiltration Test Procedure

1. A Simplified Approach Infiltration Test is required at the location of where the facility is proposed or within the immediate vicinity. The test must be conducted in the twenty-four months prior to the date the plans are submitted for review.
2. Excavate a test hole to the depth of the bottom of the infiltration system. The test hole can be excavated with small excavation equipment or by hand using a shovel, auger, or post hole digger. If a layer hard enough to prevent further excavation is encountered, or if noticeable moisture/water is encountered in the

soil, stop and measure this depth from the surface and record it on the Simplified Approach Form. Proceed with the test at this depth.

3. Fill the hole with water to a height of about 6 inches from the bottom of the hole, and record the exact time it takes for the water to draw down to the bottom of the test pit. Check the water level at regular intervals (every 1 minute for fast-draining soils to every 10 minutes for slower-draining soils) for a minimum of 1 hour or until all of the water has infiltrated. Record the distance the water has dropped from the top edge of the hole for each time interval.
4. Repeat this process two more times, for a total of three rounds of testing. These tests should be performed as close together as possible to accurately portray the soil's ability to infiltrate at different levels of saturation. The third test provides the best measure of the infiltration rate at saturated conditions.
5. For each test pit required, submit all three testing results with the date, duration, drop in water height, and conversion into inches per hour.

If the result from the third round of testing is greater than 2.0 inches per hour, the applicant can proceed with Simplified Approach facility design (where applicable). The Simplified Approach requires one infiltration test for every proposed facility. If the applicant would like to use an infiltration rate for design purposes, a Presumptive or Performance Infiltration Test must be conducted.

Presumptive and Performance Infiltration Test Requirements

The Presumptive Approach ([Section 2.2.2](#)) or Performance Approach ([Section 2.2.3](#)) must be used for all public and private developments where the Simplified Approach is not applicable. The qualified professional must exercise judgment in the selection of the infiltration test method. The three infiltration testing methods used to determine a design infiltration rate are:

- Open pit falling head.
- Encased falling head.
- Double-ring infiltrometer.

Where satisfactory data from adjacent areas using similar infiltration testing methods is available that demonstrates infiltration testing is not necessary, the infiltration testing requirement may be waived by the BES design reviewer. A recommendation for forgoing infiltration testing must be submitted in a report which includes supporting data and is stamped and signed by the project geotechnical engineer or project geologist.

Testing Criteria

- Testing must be conducted or overseen by a qualified professional. This professional must be a Professional Engineer (PE) or Registered Geologist (RG) licensed in the State of Oregon.
- The depth of the test must correspond to the facility depth. If a confining layer, or soil with a greater percentage of fines, is observed during the subsurface investigation to be within 4 feet of the bottom of the planned infiltration system, the testing should be conducted within that confining layer. Based on DEQ requirements and conformance with any required Depth to Groundwater Investigation Requirements, the boring log must be continued to a depth adequate to show separation between the bottom of the infiltration facility and the seasonal high groundwater level. (The boring depth will vary, based on facility depth.)
- Tests must be performed in the immediate vicinity of the proposed facility. Exceptions can be made to the test location provided the qualified professional can support that the strata are consistent from the proposed facility to the test location. The test must be conducted in the twenty-four months prior to the date the plans were submitted for review.
- Infiltration testing should not be conducted in engineered or undocumented fill.

Factors of Safety

Table 2-2 lists the minimum allowable factors of safety applied to field obtained infiltration rates for use in stormwater system design under the Presumptive and Performance design approaches. To obtain the infiltration rate used in design, divide the infiltration rate measured in the field by the factor of safety. The factor of safety used in design should be chosen by collaboration between the geotechnical engineer or geologist overseeing the infiltration testing and the civil engineer designing the stormwater management system. Determination of the factor of safety should include consideration of project specific conditions such as soil variability, testing methods, consequences of system failure, complexity of proposed construction, etc.

Table 2-2. Minimum Allowable Factor of Safety

Test Method	Minimum Required Factor of Safety
Open Pit Falling Head	2
Encased Falling Head	2
Double-Ring Infiltrometer	1

Presumptive and Performance Infiltration Testing Instructions

The following sections provide instructions for completing the open pit falling head infiltration test, the encased falling head infiltration test, and the double-ring infiltrometer infiltration test.

Open Pit Falling Head Procedure

The open pit falling head procedure is performed in an open excavation and therefore is a test of the combination of vertical and lateral infiltration.

- 1) Excavate a hole with bottom dimensions of approximately 2 feet wide by 2 feet deep into the native soil to the elevation of the proposed facility bottom. The test can be conducted in a machine-excavated pit or a hand-dug pit using a shovel, post hole digger, or hand auger. If smooth augering tools or a smooth excavation bucket are used, scratch the sides and bottom of the hole with a sharp pointed instrument, and remove the loose material from the bottom of the test hole.
- 2) Fill the hole with clean water a minimum of 12 inches, and maintain this depth of water for at least 4 hours (or overnight if clay soils are present) to presoak the native material.
- 3) Determine how the water level will be accurately measured. The measurements should be made with reference to a fixed point. A lath placed in the test pit prior to filling or a sturdy beam across the top of the pit are convenient reference points. The tester and excavator should conduct all testing in accordance with OSHA regulations.
- 4) After the presaturation period required by #2 above, refill the hole with water to 12 inches and record the draw-down time. Alternative water head heights may be used for testing provided the presaturation height is adjusted accordingly and the water head height used in infiltration testing is no more than 50 percent of water head height in the proposed stormwater system during the design storm event. Measure the water level to the nearest 0.01 foot ($\frac{1}{8}$ inch) at 10-minute

intervals for a total period of 1 hour (or 20-minute intervals for 2 hours in slower draining soils) or until all of the water has drained. In faster draining soils (sands and gravels), it may be necessary to shorten the measurement interval in order to obtain a well defined infiltration rate curve. Constant head tests may be substituted for falling head tests at the discretion of the professional overseeing the infiltration testing.

- 5) Repeat the infiltration test until the change in measured infiltration rate between two successive trials is no more than 10 percent. The trial should be discounted if the infiltration rate between successive trials increases. At least three trials must be conducted. After each trial, the water level must be readjusted to the 12 inch level. Enter results into the data table (see Table 2-3 for an example infiltration test table and Table 2-4 for a blank table).
- 6) The average infiltration rate over the last trial should be used to calculate the design infiltration rate without a factor of safety applied. Alternatively, the infiltration rate measured over the range of water head applicable to the project stormwater system design may be used at the discretion of the professional overseeing the testing. The final rate must be reported in inches per hour.
- 7) Upon completion of the testing, the excavation must be backfilled.
- 8) For very rapidly-draining soils, it may not be possible to maintain a water head above the bottom of the test pit. If the infiltration rate meets or exceeds the flow of water into the test pit, approximate the area over which the water is infiltrating, measure the rate of water discharging into the test pit (using a water meter, bucket or other device), and calculate the infiltration rate by dividing the rate of discharge (cubic inches per hour) by the area over which it is infiltrating (square inches). A maximum infiltration rate of 20 inches per hour can be used in stormwater system design with this type of infiltration test..

Encased Falling Head Procedure

The encased falling head procedure is performed with a 6-inch diameter casing that is embedded approximately 6 inches into the native soil. The goal of this field test is to evaluate the vertical infiltration rate through a 6-inch plug of soil, without allowing any lateral infiltration. The test is not appropriate in gravelly soils or in other soils where a good seal with the casing cannot be established.

- 1) Embed a solid 6-inch diameter casing into the native soil at the elevation of the proposed facility bottom (see Figure 2-33). Ensure that the embedment provides a good seal around the pipe casing so that percolation will be limited to the 6-

inch plug of the material within the casing. This method can also be used when testing within hollow stem augers, provided the driller and tester are reasonably certain that a good seal has been achieved between the soil and auger.

- 2) Fill the pipe with clean water a minimum of 1 foot above the soil to be tested, and maintain this depth for at least 4 hours (or overnight if clay soils are present) to presoak the native material. Any soil that sloughed into the hole during the soaking period should be removed. In sandy soils with little or no clay or silt, soaking is not necessary. If after filling the hole twice with 12 inches of water, the water seeps completely away in less than 10 minutes, the test can proceed immediately.
- 3) To conduct the first trial of the test, fill the pipe to approximately 12 inches above the soil and measure the water level to the nearest 0.01 foot ($\frac{1}{8}$ inch). Alternative water head heights may be used for testing provided the presaturation height is adjusted accordingly and the water head height used in infiltration testing is 50 percent or less than the water head height in the proposed stormwater system during the design storm event. The level should be measured with a tape or other device with reference to a fixed point. The top of the pipe is often a convenient reference point. Record the exact time.
- 4) Measure the water level to the nearest 0.01 foot ($\frac{1}{8}$ inch) at 10-minute intervals for a total period of 1 hour (or 20-minute intervals for 2 hours in slower soils) or until all of the water has drained. In faster draining soils (sands and gravels), it may be necessary to shorten the measurement interval in order to obtain a well defined infiltration rate curve. Constant head tests may be substituted for falling head tests at the discretion of the professional overseeing the infiltration testing. Successive trials should be run until the percent change in measured infiltration rate between two successive trials is minimal. The trial should be discounted if the infiltration rate between successive trials increases. At least three trials must be conducted. After each trial, the water level is readjusted to the 12 inch level. Enter results into the data table (see Table 2-3 for an example infiltration test data table and Table 2-4 for a blank data table).
- 5) The average infiltration rate over the last trial should be used to calculate the unfactored infiltration rate. Alternatively, the infiltration rate measured over the range of water head applicable to the project stormwater system design may be used at the discretion of the professional overseeing the testing. The final rate must be reported in inches per hour.

- 6) Upon completion of the testing, the casing should be pulled and the test pit backfilled.

Figure 2-33. Encased Falling Head Illustration

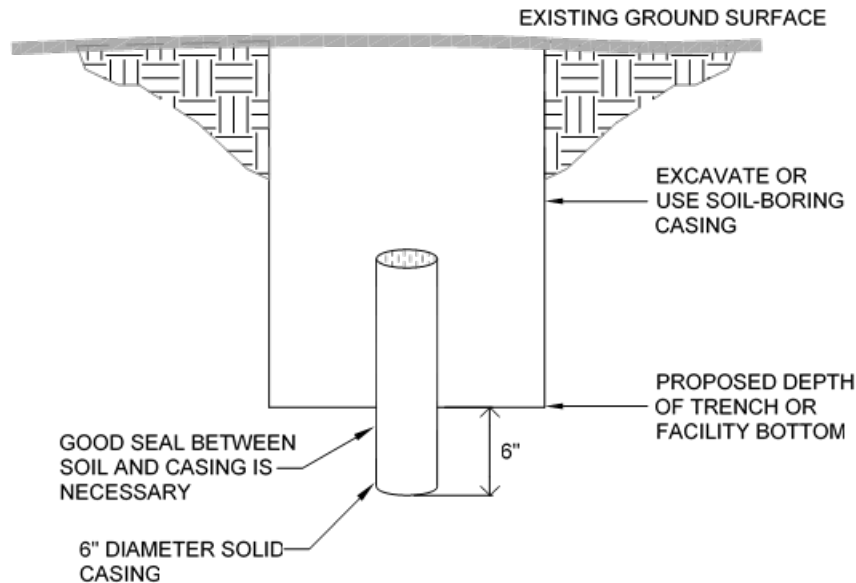

Double-Ring Infiltrometer Test

The double-ring infiltrometer test procedure should be performed in accordance with ASTM 3385-94. The test is performed within two concentric casings embedded and sealed to the native soils. The outer ring maintains a volume of water to diminish the potential of lateral infiltration through the center casing. The volume of water added to the center ring to maintain a static water level is used to calculate the infiltration rate. The double-ring infiltrometer is appropriate only in soils where an adequate seal can be established.

Infiltration Test Report Requirements

If an Infiltration Test Report is required under the Simplified Approach, it must be submitted within two weeks of BES staff request. For Presumptive and Performance Approaches, the Infiltration Test Report must be attached to the project's Stormwater Management Report. The following information must be included in the Infiltration Testing Report:

- Statement of project understanding (proposed stormwater system).
- Name, contact information, professional license information and qualifications of the person conducting the infiltration test.
- Summary of subsurface conditions encountered, including soil textures and the depth that they were found.
- Summary of pre-saturation timing.
- Summary of infiltration testing including location and number of tests and testing method used. Discussion of how the tests were performed (i.e. pipe type or diameter or test pit dimensions).
- Infiltration testing results in inches per hour for each interval as well as the average for the entire testing period
- Recommended design infiltration rate.
- Groundwater observations within exploration and an estimate of the depth to seasonal high groundwater.
- Site plan showing location of infiltration tests.
- Boring or test pit logs. Boring or test pit logs will be required when an applicant's proposal relies on the presence of specific subsurface strata that allows infiltration. The logs must include an associated soil classification consistent with ASTM D2488-00, Standard Practice for Classification for Description and Identification of Soils (Visual-Manual Procedure). The logs must also include any additional pertinent subsurface information, such as soil moisture conditions, depth and description of undocumented or engineered fill, soil color and mottling conditions, soil stiffness or density, and approximate depth of contact between soil types.
- A summary of the Infiltration Test Data Tables (see Table 2-3 for an example data table and see Table 2-4 for a blank data table).

Table 2-3. Example Infiltration Test Table

Location: Lot 105, Point Heights Subdivision		Date: 6/28/2008		Test Hole Number: 3	
Depth to bottom of hole: 57 inches		Dimension of hole: 0.5 feet diameter		Test Method: Encased Falling Head	
Tester's Name: C.J. Tester Tester's Company: Tester Company Tester's Contact Number: 555-1212					
Depth (feet):			Soil Texture:		
0-0.5			Black Top Soil		
0.5-1.0			Brown SM		
1.0-2.2			Brown ML		
2.2-5.1			Brown CL		
Presaturation Start Time:					
Presaturation End Time:					
Time:	Time interval (minutes):	Measure ment, (feet):	Drop in water level, (feet):	Infiltration rate, (inches per hour):	Remarks:
9:00	0	3.75	-		Filled with 6"
9:20	20	3.83	0.08		
9:40	20	3.91	0.08	2.88	
10:00	20	3.98	0.07	2.52	
10:20	20	4.04	0.06	2.16	
10:40	20	4.11	0.07	2.52	
11:00	20	4.17	0.06	2.16	
11:20	20	4.225	0.055	1.98	
					Adjusted to 6" level for Trial #2

Table 2-4. Infiltration Test Data Table

Location:		Date:		Test Hole Number:	
Depth to bottom of hole:		Dimension of hole:		Test Method:	
Tester's Name: Tester's Company: Tester's Contact Number:					
Depth (feet):			Soil Texture:		
Presaturation Start Time: Presaturation End Time:					
Time:	Time Interval (minutes):	Measurement, (feet):	Drop in water level, (feet):	Infiltration rate, (inches per hour):	Remarks:

Blended Soil Specification for Vegetated Stormwater Systems

Public facilities must use the Vegetated Stormwater Facility Blended Soil specification taken from the [City of Portland Standard Construction Specifications](#), as amended or corrected. Public facilities, either in the public right-of-way or on property, are required to use the specification from the most current version of the *City of Portland Standard Construction Specifications*. Facilities include swales, planters, curb extensions, and basins. The most current specification language is available in *Blended Soil Specification for Vegetated Stormwater Systems*.

Private facilities must use a blended soil that supports healthy plants growth. Testing and submittals are not required for private facilities unless they are requested by the Bureau permitting the work.

2.4 Submittal Requirements

Stormwater requirements on development-related improvements and projects go through a variety of review and permitting processes. The required submittals may vary by type of review (e.g. land use versus building permit) or sizing methodology (e.g. Simplified Approach versus Presumptive Approach). The following requirements are minimum standards that must be met in order for BES staff involved with land use/early assistance cases, building permits, and public works permits to determine if the development proposal meets the requirements of this manual.

2.4.1 Landscape Submittal Requirements

Landscape specifications and plans are required with all permits that include at least one vegetated stormwater facility. The only exception is where a contract with the Bureau of Environmental Services Watershed Revegetation Program is confirmed. For facility specific requirements including plant density and size requirements see [Section 2.3.4](#). For template planting plans for Green Streets, see typical details in [Section 2.3.5](#).

Landscape specifications and plans must address all elements that ensure plant survival and overall stormwater facility functional success. At a minimum, landscape specifications and plans must include:

- A planting plan that indicates existing vegetation to be preserved, the location of all landscape elements, and the size, species and location of all proposed plantings. The plant species should be selected and placed in accordance with proper delineation of Zone A (wet zone) and Zone B (moderate to dry zone), where appropriate.
- A plant list or table, including botanic and common names, size at time of planting, quantity, spacing, type of container, evergreen or deciduous, and other information related to the facility-specific planting, in accordance with landscape industry standards.
- Trees identified for the tree credit clearly labeled (if applicable). A Tree Credit Worksheet must be submitted if requesting tree credit.
- A soil analysis for the stormwater facility growing medium (required for all public facilities and may be required for private facilities). A soil analysis is not required for single-family residential sites. The source of the growing medium must be provided. The location of all stockpiles must be indicated

on plans, including erosion protection measures per the City's Erosion Control Manual.

- The method of irrigation to be used for the establishment period and for the permanent long-term. Public stormwater management facilities must be designed so permanent long-term irrigation systems are not needed.

Tree Credit Worksheet

Trees may reduce the size of required stormwater facilities or even eliminate stormwater management requirements on small project proposals. Tree Credit can be used with any design approach (see [Section 2.3.4.3](#) for information on tree credit uses and limitations). The [Tree Credit Worksheet](#) contains the information needed to apply tree credit to stormwater requirements and consists of the following sections:

- Information on new trees.
- Information on existing trees.
- Information on allowable tree credit.

Planting Zones and Plant Lists

The following sections provide guidance and requirements for planting vegetation in stormwater management facilities.

Planting Zones

Within a stormwater management facility, a planting zone indicates different areas of stormwater inundation (see Figure 2-34). Plants recommended or required for specific stormwater management facilities have different tolerances for inundation.

Zone A: Area of the facility defined as the bottom of the facility to the designed high water mark. This area has moist to wet soils and plants located here must be tolerant of mild inundation.

Zone B: Area of the facility defined as the side slopes from the designed high water line up to the edge of the facility. This area typically has dryer to moist soils, with the moist soils being located further down the side slopes. Plants here should be drought tolerant and help stabilize the slopes.

Areas outside of Zone A and Zone B or above the freeboard are not considered part of the facility and are not covered by these requirements

**Figure 2-34. Planting Zones
Sloped Facility**

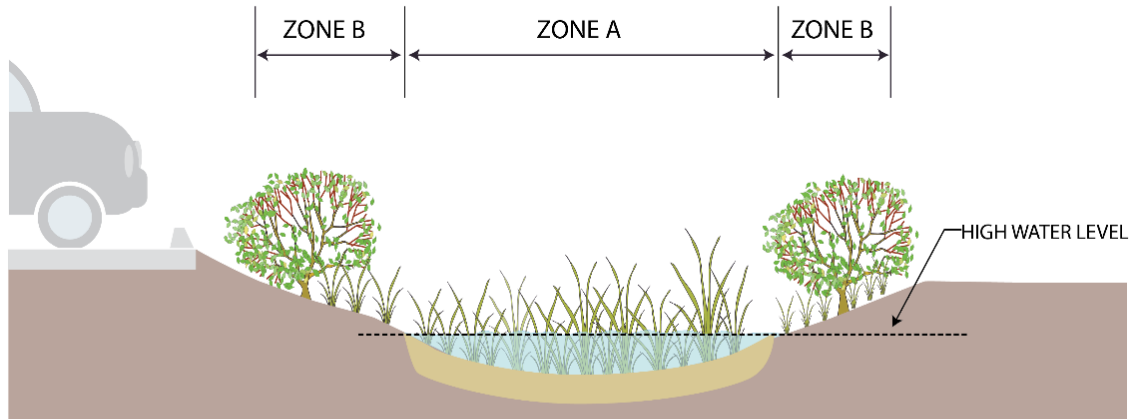

City of Portland Environmental Services ES 1604

Flat-bottom Facility

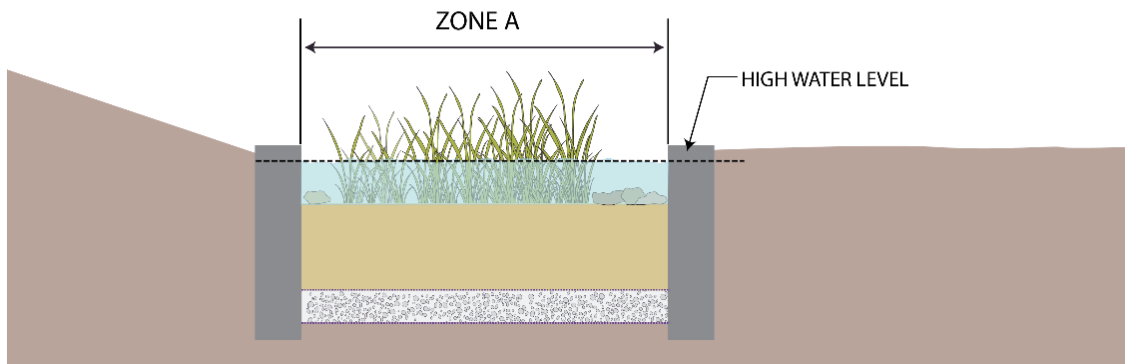

City of Portland Environmental Services ES 1604

Plant Lists

For more information about a number of these plants, please visit the [Portland Plant List](#). No plants off the Portland Nuisance Plant List area allowed in stormwater management facilities or drainageways (See Section 4.1 of the [Portland Plant List](#)). A number of other plants may be appropriate for private stormwater management facilities – see Section 2.4 (Deciduous Forested Wetlands and Floodplains), Section 2.5 (Scrub-Shrub Wetlands) and Section 2.6 (Marsh) of the [Portland Plant List](#). Additionally, see the [Bureau of Development Services Tree and Landscaping Manual](#) for plant suggestions that also meet required landscaping and screening goals.

Ecoroof Plant List

	Botanic Name	Common Name	NW Native	Evergreen	Potential Height	Full Sun	Partial Shade
Succulents	<i>Delosperma cooperi</i>	Ice Plant	N	Y	4"	X	X
	<i>Delosperma nubigenum</i>	Ice Plant	N	Y	2"	X	X
	<i>Opuntia</i> spp.	Prickly-Pear Cactus	N	N	5"	X	X
	<i>Sedum acre</i>	Biting Stonecrop	N	Y	2"	X	X
	<i>Sedum album</i>	White Stonecrop	N	Y	3"	X	X
	<i>Sedum divergens</i>	Pacific Stonecrop	Y	Y	3"	X	X
	<i>Sedum hispanicum</i>	Spanish Stonecrop	N	Y	3"	X	X
	<i>Sedum kamtschaticum</i>	Kirin-so	N	N	6"	X	X
	<i>Sedum lanceolatum</i>	Lance-leaved Stonecrop	Y	N	4"	X	X
	<i>Sedum oreganum</i>	Oregon Stonecrop	Y	Y	4"	X	X
	<i>Sedum oregonense</i>	Creamy Stonecrop	Y	Y	4"	X	X
	<i>Sedum rupestre</i>	Crooked Stonecrop	N	Y	6"	X	X
	<i>Sedum sexangulare</i>	Tasteless Stonecrop	N	Y	4"	X	X
	<i>Sedum spathulifolium</i>	Broad-leaved Stonecrop	Y	Y	4"	X	X
	<i>Sedum spurium</i>	Two-row Stonecrop	N	Y	6"	X	X
	<i>Sedum takesimense</i>	Gold Carpet Stonecrop	N	Y	9"	X	X
	<i>Sedum telephium</i>	Autumn Joy	N	N	24"	X	X
<i>Sempervivum tectorum</i>	Hens and Chicks	N	Y	6"	X	X	
Herbaceous Plants	<i>Achillea millefolium</i>	Common Yarrow	Y	N	36"	X	X
	<i>Allium acuminatum</i>	Hooker's Onion	Y	N	6"	X	X
	<i>Allium cernuum</i>	Nodding Onion	Y	N	12"	X	X
	<i>Antennaria neglecta</i>	Field Pussytoes	Y	N	4"	X	X
	<i>Arenaria montana</i>	Sandwort	N	N	4"	X	X
	<i>Aurinaria saxatilis</i>	Basket-of-Gold	N	N	6"	X	X
	<i>Campanula rotundifolia</i>	Common Harebell	Y	N	8"	X	X
	<i>Dianthus</i> spp.	Dianthus	N	N	12"	X	X
	<i>Erigeron compositus</i>	Fleabane	N	N	12"	X	X

Ecoroof Plant List

	Botanic Name	Common Name	NW Native	Evergreen	Potential Height	Full Sun	Partial Shade
Herbaceous Plants	<i>Erigeron glaucus</i>	Beach Aster	Y	N	6"	X	X
	<i>Festuca idahoensis</i>	Idaho Fescue	Y	Y	12"	X	X
	<i>Fragaria chiloensis</i>	Coastal Strawberry	Y	Y	6"	X	X
	<i>Fragaria virginiana</i>	Wild Strawberry	Y	Y	6"	X	X
	<i>Gaillardia aristata</i>	Blanket Flower	N	N	20"	X	X
	<i>Gazania linearis</i>	Gazania	N	N	6"	X	X
	<i>Koeleria macrantha</i>	Junegrass	Y	N	24"	X	X
	<i>Lobularia maritima</i>	Sweet Alyssum	N	N	12"	X	X
	<i>Phlox douglasii</i>	Tufted Phlox	Y	N	4"	X	X
	<i>Polypodium glycyrrhiza</i>	Licorice Fern	Y	Y	12"	X	X
	<i>Polystichum munitum</i>	Sword Fern	Y	Y	24"	X	X
	<i>Potentilla nepalensis</i>	Nepal Cinquefoil	N	N	14"	X	X
	<i>Potentilla neumanniana</i>	Cinquefoil	N	N	14"	X	
	<i>Prunella vulgaris lanceolata</i>	Self-Heal	Y	N	4"	X	X
	<i>Silene acaulis</i>	Moss Champion	Y	N	3"	X	X
	<i>Thymus serpyllum</i>	Creeping Thyme	N	N	3"	X	
<i>Veronica liwanensis</i>	Turkish speedwell	N	N	2"	X	X	
Accent Plants	<i>Camassia quamash</i>	Common Camas	Y	N	8"	X	X
	<i>Clarkia amoena</i>	Farewell-to-Spring	Y	N	7"	X	X
	<i>Gilia capitata</i>	Globe Gilia	Y	N	18"	X	X
	<i>Linaria reticulata</i>	Purplenet Toadflax	N	N	20"	X	X
	<i>Linum perenne</i>	Blue Flax	Y	N	8"	X	X
	<i>Lupinus bicolor</i>	Two-Colored Lupine	Y	N	5"	X	X
	<i>Madia elegans</i>	Elegant Tarweed	Y	N	18"	X	X
	<i>Nemophila menziesii</i>	Baby Blue Eyes	Y	N	5"	X	X
	<i>Phacelia campanularia</i>	Desert Bluebells	N	N	10"	X	X
	<i>Plectritis congesta</i>	Sea Blush	Y	N	5"	X	X
	<i>Triteleia ixoides</i>	Golden Star	Y	N	10"	X	X

Private Stormwater Facilities Plant List

	Botanic Name	Common Name	Zone	Swale	Planter	Basin	NW Native	Evergreen	Potential Height	O.C. Spacing
Herbaceous Plants	<i>Athyrium filix-femina</i>	Lady Fern	B	X		X	Y	N	36"	24"
	<i>Bromus carinatus</i>	California Brome Grass	A			X	Y	Y	18"	12"
	<i>Bromus sitchensis</i>	Alaska Brome	A			X	Y	Y	18"	12"
	<i>Bromus vulgaris</i>	Columbia Brome	A			X	Y	Y	18"	12"
	<i>Carex deweyanna</i>	Dewey Sedge	A	X	X	X	Y	Y	36"	12"
	<i>Carex densa</i>	Dense Sedge	A	X	X	X	Y	N	24"	12"
	<i>Carex obnupta</i>	Slough Sedge	A	X	X	X	Y	Y	4'	12"
	<i>Carex rupestris</i>	Curly Sedge	A	X	X	X	N	Y	14"	12"
	<i>Carex stipata</i>	Sawbeak Sedge	A	X	X	X	N	Y	20"	12"
	<i>Carex testacea</i>	New Zealand Orange Sedge	A	X	X	X	N	Y	24"	12"
	<i>Carex vesicaria</i>	Inflated Sedge	A	X	X	X	Y	Y	36"	12"
	<i>Deschampsia cespitosa</i>	Tufted Hair Grass	A/B	X	X	X	Y	Y	36"	12"
	<i>Eleocharis acicularis</i>	Needle Spike Rush	A	X	X	X	Y	Y	30"	12"
	<i>Eleocharis ovata</i>	Ovate Spike Rush	A	X	X	X	Y	Y	30"	12"
	<i>Eleocharis palustris</i>	Creeping Spike Rush	A			X	Y	Y	30"	12"
	<i>Elymus glaucus</i>	Blue Wild Rye	B	X		X	Y	Y	24"	12"
	<i>Festuca occidentalis</i>	Western Fescue Grass	A	X		X	Y	Y	24"	12"
	<i>Festuca rubra</i>	Red Fescue	B	X		X	Y	Y	24"	12"
	<i>Glyceria occidentalis</i>	Western Manna Grass	A			X	Y	Y	18"	12"
	<i>*Helictotrichon sempervirens</i>	Blue Oat Grass	B	X		X	N	Y	24"	12"
<i>Iris douglasiana</i>	Douglas Iris	B	X		X	Y	y	18"	12"	

Private Stormwater Facilities Plant List

	Botanic Name	Common Name	Zone	Swale	Planter	Basin	NW Native	Evergreen	Potential Height	O.C. Spacing
Herbaceous Plants	<i>Iris sibirica</i>	Siberian Iris	A	X	X	X	N	y	36"	12"
	<i>Iris tenax</i>	Oregon Iris	B	X		X	Y	y	18"	12"
	<i>Juncus balticus</i>	Baltic Rush	A	X	X	X	y	y	20"	12"
	<i>Juncus effusus var. pacificus</i>	Soft rush	A	X	X	X	Y	Y	36"	12"
	<i>Juncus ensifolius</i>	Dagger-leaf Rush	A	X	X	X	N	y	10"	12"
	* <i>Juncus patens</i>	Spreading Rush	A	X	X	X	N	Y	36"	12"
	<i>Juncus tenuis</i>	Slender Rush	A	X	X	X	Y	Y	36"	12"
	* <i>Liriope muscari 'Big Blue'</i>	Big Blue Liriope	A/B	X	X	X				
	<i>Lupinus bicolor</i>	Bicolor Lupine	B	X		X	Y	N	18"	12"
	<i>Lupinus polyphyllus</i>	Large-leaved Lupine	A/B	X		X	Y	N	36"	12"
	* <i>Polystichum munitum</i>	Sword Fern	A/B	X		X	Y	Y	24"	24"
	<i>Schoenoplectus americanus</i>	American Bulrush	A	X	X	X	Y	Y	30"	12"
	<i>Scripus microcarpus</i>	Small Fruited Bulrush	A			X	Y	Y	24"	12"
	<i>Scripus validus</i>	Softstem Bulrush	A	X	X	X	N	y	5'	12"
	<i>Sisyrinchium californicum</i>	Yellow-eyed Grass	A/B	X	X	X	N	Y	6"	12"
	<i>Symphotrichum subspicatum</i>	Douglas' Aster	B	X		X	Y	N	36"	12"
	<i>Veronica liwanensis</i>	Speedwell	A	X		X	N	y	2"	12"
Groundcovers	* <i>Arctostaphylos uva-ursi</i>	Kinnickinnick	B	X		X	Y	Y	6"	12"
	* <i>Berberis (Mahonia) repens</i>	Creeping Oregon Grape	B	X		X	Y	Y	12"	12"
	* <i>Fragaria chiloensis</i>	Coastal Strawberry	B	X		X	Y	Y	6"	12"
	<i>Fragaria vesca</i>	Woodland Strawberry	B	X		X	Y	Y	10"	12"
	<i>Fragaria virginiana</i>	Wild Strawberry	B	X		X	Y	Y	10"	12"
	<i>Sedum oreganum</i>	Oregon Stonecrop	B	X			X	Y	4"	12"

Private Stormwater Facilities Plant List

	Botanic Name	Common Name	Zone	Swale	Planter	Basin	NW Native	Evergreen	Potential Height	O.C. Spacing
Small Shrubs	<i>Baccaris pilularis 'Dwarf'</i>	Dwarf Coyote Bush	B	X		X	Y	Y	3'	24"
	* <i>Berberis (Mahonia) aquifolium</i>	Oregon Grape	B	X		X	Y	Y	4'	3'
	* <i>Berberis nervosa</i>	Dull Oregon Grape	B	X		X	Y	Y	24"	24"
	* <i>Ceanothus velutinus</i>	Snowbrush	B	X		X	Y	Y	4'	3'
	* <i>Cistus spp.</i>	Various rock rose species	A/B	X	X	X	N	Y	3'	3'
	<i>Cornus sericea 'Kelseyii'</i>	Kelsey Dogwood	B	X		X	N	N	24"	24"
	* <i>Hebe spp.</i>	Various hebe species	B	X		X	N	Y	2-3'	2-3'
	* <i>Ilex glabra 'Shamrock', 'Compacta'</i>	Inkberry	A/B	X	X	X	N	Y	4'	4'
	* <i>Lavendula spp.</i>	Lavender species	B	X		X	N	Y	3'	24"
	* <i>Lonicera nitida</i>	Box Honeysuckle	B	X		X	N	Y	4'	4'
	* <i>Paxistima myrsinites</i>	Oregon Boxwood	B	X		X	Y	Y	3'	4'
	<i>Rosa gymnocarpa</i>	Baldhip Rose	B	X		X	Y	N	3'	3'
	<i>Rosa nutkana</i>	Nootka Rose	B	X		X	Y	N	8'	3'
	* <i>Rosa pisocarpa</i>	Swamp Rose	A/B	X	X	X	Y	N	8'	3'
	* <i>Spirea betulifolia</i>	Birchleaf Spirea	A/B	X	X	X	N	N	3'	24"
	* <i>Spirea x bumalda cvs.</i>	Bumald Spirea	A/B	X	X	X	N	N	3'	24"
	* <i>Spirea densiflora</i>	Sub-Alpine Spirea	A/B	X	X	X	N	N	3'	24"
	* <i>Spirea japonica cvs.</i>	Various spirea cultivars	A/B	X	X	X	Y	N	3'	24"
	* <i>Symphoricarpos alba</i>	Common Snowberry	B	X		X	Y	N	6'	3'
	* <i>Therorhodion (Ledum) glandulosum</i>	Trapper's Tea	A/B	X	X	X	X	Y	1'-4'	2'
* <i>Thuja plicata dwarf and semi-dwarf species</i>	Semi-dwarf Western Red Cedar	A/B	X		X	Y	Y	3'	3'	
* <i>Vaccinium ovatum</i>	Evergreen Huckleberry	A/B	X	X	X	Y	Y	3'	3'	
* <i>Viburnum davidii</i>	David viburnum	A/B	X	X	X	Y	N	3'	3'	

Private Stormwater Facilities Plant List

	Botanic Name	Common Name	Zone	Swale	Planter	Basin	NW Native	Evergreen	Potential Height	O.C. Spacing
Large Shrubs	<i>*Arbutus unedo</i>	Strawberry Tree	B	X		X	N	Y	10'	10'
	<i>*Acer circinatum</i>	Vine Maple	A/B	X		X	Y	N	15'	10'
	<i>*Amelanchier alnifolia</i>	Western Serviceberry	B	X		X	Y	N	20'	10'
	<i>Ceanothus sanguineus</i>	Oregon Redstem Ceanothus	B	X		X	Y	N	7'	4'
	<i>*Ceanothus thyrsiflorus</i>	Blueblossom	B	X		X	Y	Y	6'	6'
	<i>*Cornus sericea</i>	Red-twig Dogwood	A/B	X	X	X	Y	N	6'	4'
	<i>*Euonymus japonicas</i>	Japanese euonymus	A/B	X		X	N	Y	6'	4'
	<i>*Fragula (Rhamnus) californica</i>	Coffeeberry (sm. cultivars)	B	X		X	N	Y	6'	6'
	<i>*Holodiscus discolor</i>	Oceanspray	B	X		X	Y	N	6'	4'
	<i>*Ilex cornuta</i>	Chinese Holly	B	X		X	N	Y	10'	4'
	<i>*Ilex crenata</i>	Japanese Holly	B	X		X	N	Y	8'	4'
	<i>Lonicera involucrata</i>	Black Twinberry	B	X		X	Y	N	5'	4'
	<i>*Morella (Myrica) californica</i>	Pacific Wax Myrtle	A/B	X	X	X	Y	Y	10'	10'
	<i>*Nandina domestica</i>	Heavenly Bamboo	A/B	X	X	X	N	Y	6'	3'
	<i>Oemleria cerasiformis</i>	Indian Plum	B	X		X	Y	N	6'	4'
	<i>*Philadelphus lewisii</i>	Wild Mock Orange	B	X		X	Y	N	6'	4'
	<i>*Physocarpus capitatus</i>	Pacific Ninebark	A/B	X	X	X	Y	N	10'	3'
	<i>*Ribes sanguineum</i>	Red-Flowering Current	B	X		X	Y	N	8'	4'
	<i>Rubus parviflorus</i>	Thimbleberry	B	X		X	Y	N	8'	4'
	<i>Rubus spectabilis</i>	Salmonberry	A	X	X	X	Y	N	10'	4'
	<i>Salix purpurea 'Nana'</i>	Blue Arctic Willow	B	X		X	N	N	8'	6'
	<i>Salix stichensis</i>	Sitka Willow	A	X	X	X	Y	N	20'	6'
<i>Sambucus nigra ssp. cerulea</i>	Blue Elderberry	B	X		X	Y	N	10'	10'	
<i>Sambucus racemose var. arborescens</i>	Red Elderberry	B	X		X	Y	N	10'	10'	
<i>*Spiraea douglasii</i>	Douglas' Spirea	A/B	X	X	X	Y	N	7'	4'	

Private Stormwater Facilities Plant List

	Botanic Name	Common Name	Zone	Swale	Planter	Basin	NW Native	Evergreen	Potential Height	O.C. Spacing
Large Shrubs	* <i>Thuja occidentalis</i>	American Arborvitae (Emerald)	B	X		X	N	Y	12'	3'
	* <i>Viburnum cinnamomifolium</i>	Cinnamon Leaf Viburnum	B	X		X	N	Y	8'	8'
	<i>Viburnum edule</i>	Highbush Cranberry	A/B	X	X	X	Y	N	6'	4'
	* <i>Viburnum tinus</i>	Laurustinus viburnum	A/B	X	X	X	Y	N	6'	5'
Trees	* <i>Abies grandis</i>	Grand Fir	B			X	Y	Y	150'	-
	* <i>Acer camperstre</i>	Hedge Maple	A/B				N	N	50'	-
	* <i>Acer griseum</i>	Paperbark Maple	B	X		X	N	N	30'	-
	* <i>Acer macrophyllum</i>	Big Leaf Maple	B	X		X	Y	Y	60'	-
	* <i>Alnus rhombifolia</i>	White Alder	A/B				Y	Y	100'	-
	* <i>Alnus rubra</i>	Red Alder	A	X		X	Y	N	80'	-
	<i>Arbutus menziesii</i>	Madrone	B			X	Y	N	35'	-
	* <i>Calocedrus decurrens</i>	Incense Cedar	A/B	X	X	X	Y	Y	100'	-
	* <i>Celtis occidentalis</i>	Common Hackberry	A/B	X	X	X	N	Y	100'	-
	* <i>Celtis reticulata</i>	Western Hackberry	B	X		X	N	N	30'	-
	<i>Crataegus douglasii</i>	Black Hawthorn	A	X		X	Y	N	40'	-
	<i>Crataegus gaylorii</i> (suksdorfii)	Suksdorf's Hawthorne	A/B				Y	N	40'	-
	* <i>Fraxinus latifolia</i>	Oregon Ash	A/B	X		X	Y	N	30'	-
	* <i>Frangula purshiana</i>	Cascara	A/B	X	X	X	Y	N	30'	-
	* <i>Gleditsia tricanthos</i>	Honeylocust	A/B				N	N	40'	-
	<i>Malus fusca</i>	Pacific Crabapple	A	X	X	X	Y	N	30'	-
	* <i>Metasequoia glyptostroboides</i>	Dawn Redwood	B			X	N	N	80'	-
	* <i>Nyssa sylvatica</i>	Tupelo, sour gum	A/B				N	N	75'	-
	* <i>Populus tremuloides</i>	Quaking Aspen	A			X	Y	N	40'	-
	<i>Prunus emarginata var. mollis</i>	Bitter Cherry	A/B	X	X	X	Y	N	50'	-
* <i>Pseudotsuga menziesii</i>	Douglas Fir	B	X		X	Y	Y	200'	-	

Private Stormwater Facilities Plant List

	Botanic Name	Common Name	Zone	Swale	Planter	Basin	NW Native	Evergreen	Potential Height	O.C. Spacing
Trees	<i>*Quercus bicolor</i>	Swamp Oak	A/B				N	N	60'	-
	<i>*Quercus chrysolepis</i>	Canyon Live Oak	A/B				Y	Y	40'	-
	<i>*Quercus garryana</i>	Oregon White Oak	B	X		X	Y	N	100'	-
	<i>*Quercus phellos</i>	Willow Oak	A/B				N	N	90'	-
	<i>*Quercus wislizenii</i>	Interior Live Oak	A/B				N	Y	70'	-
	<i>Salix hookeriana</i>	Hooker's Willow	A/B	X	X	X	Y	N	15'	-
	<i>Salix scouleriana</i>	Scouler's Willow	A/B	X	X	X	Y	N	15'	-
	<i>*Taxodium distichum</i>	Bald Cypress	A/B				N	N	100'	-
	<i>*Thuja plicata</i>	Western Red Cedar	A			X	Y	Y	150'	-
	<i>*Thuja plicata 'Hogan'</i>	Hogan Western Red Cedar	A/B				Y	Y	50'	-
	<i>*Tsuga heterophylla</i>	Western Hemlock	A	X		X	Y	Y	125'	-
	<i>Salix exigua var. Columbiana</i>	Columbia Willow	A/B	X	X	X	Y	N	13'	-
	<i>Salix lasiandra var. lasiandra</i>	Pacific Willow	A	X	X	X	Y	N	13'	-

*These plants are also listed in the Bureau of Development Services [Tree and Landscaping Manual Suggested Plant List](#) and may be appropriate for meeting screening requirements.

Grassy Swale Native Seed Mix

This is a recommended mix, but other mixes are also permitted. Percentages are by weight, 90% PLS (pure live seed):

- Hordeum brachyantherum* (Meadow Barley) = 25%
- Danthonia californica* (California Oat-grass) = 15%
- Elymus glaucus* (Blue Wild Rye) = 10%
- Bromus carinatus* (California Brome) = 10%
- Festuca romerii* (Roemer's fescue) = 10%
- Deschampsia cespitosa* (Tufted hairgrass) = 10%
- Agrostis exarata* (Spike bentgrass) = 10%
- Alopecurus geniculatus* (Water foxtail) = 5%
- Deschampsia elongata* (Slender hairgrass) = 5%

Public Stormwater Facility Plant List
(including Green Streets and Basins)

	Botanic Name	Common Name	Zone	NW Native	Evergreen	Potential Height	O.C. Spacing	Under Powerlines
Herbaceous Plants	<i>Carex obnupta</i>	Slough Sedge	A	Y	Y	48"	12"	-
	<i>Juncus patens</i>	Spreading Rush	A	y	Y	36"	12"	-
	<i>Liriope muscari</i> 'Big Blue'	Big Blue Lilyturf	A/B	N	Y	12-18"	12"	-
Groundcovers	<i>Arctostaphylos uva-ursi</i>	Kinnickinnick	B	Y	Y	6"	12"	-
	<i>Fragaria chiloensis</i>	Coastal Strawberry	B	Y	Y	6"	12"	-
	<i>Rubus calcynoides & pentalobus</i>	Creeping Bramble	A	N	Y	6"	12"	-
Accent Plants	<i>Carex morrowii</i> 'Ice Dance'	Ice Dance Japanese sedge	A/B	N	N	12"	12"	-
	<i>Iris douglasiana</i>	Douglas Iris	B	Y	N	18"	12"	-
Small Shrubs	<i>Berberis (Mahonia) repens</i>	Creeping Oregon Grape	B	Y	Y	18-24"	24"	-
	<i>Cornus sericea 'Kelseyi'</i>	Kelsey's dwarf red-twig dogwood	A/B	N	N	36"	24"	-
	<i>Lavandula angustifolia</i> 'Hidcote Blue'	Hidcote Blue English lavender	B	N	Y	24-36"	24"	-
	<i>Nandina domestica</i> 'Moon Bay'	Moon Bay heavenly bamboo	A/B	N	Y	36"	24"	-
	<i>Nandina domestica</i> 'Nana'	Dwarf heavenly bamboo	B	N	Y	15"	24"	-

Public Stormwater Facility Plant List
(including Green Streets and Basins)

	Botanic Name	Common Name	Zone	NW Native	Evergreen	Potential Height	O.C. Spacing	Under Powerlines
Small Shrubs	<i>Spiraea japonica</i> 'Walbuma'	Magic Carpet Japanese spirea	A/B	Y	N	24"	24"	-
	<i>Spiraea japonica</i> 'Goldmound'	Goldmound Japanese spirea	A/B	N	N	36"	24"	-
Trees	<i>Celtis occidentalis</i>	Common Hackberry		N	N	50'	-	N
	<i>Frangula purshiana</i>	Cascara Buckthorn, Cascara Sagrada		Y	N	25'	-	Y
	<i>Gleditsia triacanthos</i> <i>var. inermis</i> 'Impcole'	Imperial Thornless Honeylocust		N	N	35'	-	Y
	<i>Gleditsia triacanthos</i> <i>var. inermis</i> 'Skycole'	Skyline Thornless Honeylocust		N	N	50'	-	N
	<i>Nyssa sylvatica</i>	Black Tupelo		N	N	50'	-	N
	<i>Prunus virginiana</i> 'Canada Red'	Canada Red Chokecherry	A/B	N	N	25'	-	Y
	<i>Quercus bicolor</i>	Swamp White Oak		N	N	50'	-	N
	<i>Quercus shumardii</i>	Shumard Oak	A/B	N	N	50'	-	N
	<i>Zelkova serrata</i> 'Green Vase'	Green vase Japanese zelkova		N	N	45'	-	N
<i>Zelkova serrata</i> 'Village Green'	Village Green Japanese zelkova		N	N	35'	-	Y	

Minimum size is a # 1 Container for all plants, 2"- 3.5" caliper B&B for all trees.



TREE CREDIT WORKSHEET

Trees may be able to reduce the size of required stormwater facilities. Small projects, such as residential additions or new detached structures (garages, sheds, accessory dwelling units), may be able to eliminate stormwater requirements through use of tree credit. Trees used for tree credit must be clearly labeled on the site plan and included on the Stormwater Operations & Maintenance Plan.

Tree Credit Applicability:

- For sites with more than 1,000 square feet of new or redeveloped impervious surface to manage, no more than 10% of the impervious area can be mitigated with through tree credit.
- Nuisance trees cannot receive stormwater tree credit.
- BES may require a certified arborists' report to verify suitable tree selection and preservation.
- Trees planted in stormwater facilities or used towards environmental zone mitigation cannot also receive tree credit.
- New trees must be located within 10 feet of impervious surfaces to qualify for tree credit.
- Existing trees must be located within 25 feet of impervious surfaces to qualify for tree credit.

CALCULATE TREE CREDIT

New trees must be at least 1.5 caliper inches at the time of planting; new coniferous trees must be at least 5 feet tall.

NEW TREES

TYPE OF TREE	NUMBER OF TREES	CREDIT PER TREE	TREE CREDIT (SF)
New coniferous trees		Multiply by 200 square feet	
New broadleaf trees		Multiply by 100 square feet	

SMALL TREES *(Existing trees with caliper of 1.5 to 6 inches)*

	NUMBER OF TREES	CREDIT PER TREE	TREE CREDIT (SF)
Existing trees with caliper of 1.5 to 6 inches		Multiply by 200 square feet	

EXISTING TREES

LARGE TREES *(Larger than 6 caliper inches)*

TYPE OF TREE	CALIPER SIZE <i>(in inches)</i>	DETERMINE CREDIT UNITS	CREDIT UNITS PER TREE <i>(Do not round up)</i>	CREDIT PER 6 CALIPER INCHES	TREE CREDIT (SF)
		Divide by 6		Multiply by 400 square feet	
		Divide by 6		Multiply by 400 square feet	
		Divide by 6		Multiply by 400 square feet	
		Divide by 6		Multiply by 400 square feet	
		Divide by 6		Multiply by 400 square feet	
		Divide by 6		Multiply by 400 square feet	
		Divide by 6		Multiply by 400 square feet	
		Divide by 6		Multiply by 400 square feet	

TOTAL TREE CREDIT

Continue on back

TREE CREDIT WORKSHEET

ALLOWABLE TREE CREDIT

For sites with less than 1,000 square feet of new or redeveloped impervious area, the Total Tree Credit is allowed. Stormwater runoff may go to the existing disposal location.

Allowable Tree Credit = Total Tree Credit

For sites with over 1,000 square feet of new or redeveloped impervious area, a maximum of 10% of the new or redeveloped impervious area can be mitigated through tree credit.

TOTAL NEW OR REDEVELOPMENT IMPERVIOUS AREA (SF)	MAXIMUM TREE CREDIT	TOTAL ALLOWABLE TREE CREDIT (SF)
	Multiply by 0.10	

Allowable Tree Credit is the lesser of the Total Tree Credit or the Total Allowable Tree Credit

Allowable Tree Credit =

2.4.2 Land Use Submittal Requirements

Land use review applications must include a conceptual Stormwater Management Plan that indicates how the site will meet stormwater management requirements (see [Section 1.3.1](#)). To meet zoning code requirements (Title 33 of Portland City Code) and use the available land most efficiently, the applicant must determine the proposed stormwater management facilities and any drainage reserve requirements and illustrate them on a site plan. The size and location of the proposed facilities will be assessed during the review process to ensure that adequate space is available with required setbacks. The facilities must also be located for proper overflow or access to an approved discharge location.

The Bureau of Environmental Services (BES) and the Bureau of Development Services (BDS) work cooperatively to review proposed plans during land use review to ensure stormwater management requirements are met. BES assesses the Stormwater Management Plan to determine if it meets the *Stormwater Management Manual* and [Sewer and Drainage Facilities Design Manual](#) requirements. BES provides the technical assessment information to BDS to determine if the land use review application meets zoning code approval criteria.

It is the applicant's responsibility to demonstrate that the stormwater hierarchy requirements are met. Some land use applications require more detailed information and more thorough planning and coordination with BES than others prior to land use approval. The determining factors are related to the type of land use review, the complexity of the proposed project, and the existing site conditions.

Land use applications that must address stormwater management can generally be divided into the following two categories:

- Those that verify adequacy of services, such as land divisions, planned developments, zone changes, and conditional uses.
- Those that verify the available area for stormwater management and in some cases the impact of the stormwater management system, such as environmental reviews; greenway reviews; design reviews; and adjustments to regulations such as setbacks, building coverage, and paved area.

Completing and documenting the first six steps presented in [Section 2.1.2](#) will meet most, if not all, of the submittal requirements for the Stormwater Management Report and the BES land use review process.

The applicant must determine the anticipated stormwater management design approach (Simplified, Presumptive, or Performance) that will be used. When the

Presumptive or Performance Approach is used, the applicant must complete and submit the project overview and description, methodology, analysis, and engineering conclusions (described in the Stormwater Management Report outlined in [Section 2.4.6](#)) with submittal of the application.

To determine which category of the stormwater hierarchy (see [Section 1.3.1](#)) the project will meet, the applicant must establish if, and to what degree, onsite infiltration is feasible (see [Section 2.3.6](#) for infiltration testing requirements). In addition to providing the justification necessary to select a category of the stormwater hierarchy, the results of the infiltration testing will contribute to decisions regarding type, size, and location of stormwater facilities.

Other Design Considerations:

- Perimeter landscaping requirements, limited available area meeting setback requirements, and the need for impermeable liners or watertight planter boxes may make stormwater facilities impractical along property lines.
- Elevation and topographic constraints must be evaluated to ensure that gravity flow is possible and plumbing code depth of cover requirements for pipes can be met.
- Coordination between the project engineer, architect, and landscape designer may be necessary to ensure that potential conflicts with construction methods and materials (geogrids, drains, footings, foundations, limitations on rooting depth imposed by planter box dimensions, impervious liners, etc.) are considered during the selection of trees and landscaping plantings.
- The landscape design should minimize potential impacts of plants and tree roots on stormwater facilities and utilities, including under drains, storm sewer, and rain drains.
- Tree preservation and tree planting must account for not only initial construction, but also the need for future maintenance of stormwater facilities and utilities.
- Arborist reports should address all stormwater facilities and utilities proposed to encroach in the root protection zones of trees required to be preserved.

When stormwater management is required, the applicant must provide adequate information to show that the proposed development can meet the stormwater requirements at the time of development. In general, this includes:

- A plant list or table, including botanic and common names, size at time of planting, quantity, spacing, type of container, evergreen or deciduous, and other information related to the facility-specific planting, in accordance with landscape industry standards.
- A site utility plan that includes stormwater management facilities with a proposed discharge location and drainageway protection requirements (if applicable).
- If public street improvements will be required as a condition of land use approval, a plan for managing stormwater from the street and identification of required right-of-way dedications (that include space for stormwater management facilities).
- A Stormwater Management Report (see [Section 2.4.6](#)) describing how the proposal complies with the stormwater hierarchy, including supporting documentation such as infiltration testing (see [Section 2.3.6](#)) and calculations, per the requirements of the appropriate design approach (see detailed requirements of the Simplified, Presumptive, and Performance approaches in [Section 2.4.3](#), [2.4.4](#), or [2.4.5](#)).
- Other requirements, depending on the site and complexity of the project. Examples include a grading plan, geotechnical report, and groundwater level testing (see [Section 2.3.6](#)).

The use of the Presumptive and Performance Approach (required for larger and/or complex projects) require the stormwater submittal to be prepared by a qualified professional, as outlined in [Section 2.2](#). The Presumptive Approach submittal must include Presumptive Approach Calculator (PAC) printouts that demonstrate the stormwater facility engineering.

Issues that frequently delay Land Use Review applications

Land use applications that cannot be fully processed or approved often have the following deficiencies related to stormwater management:

- It is not clear whether infiltration is feasible on the site.
- It is not clear which category of the stormwater hierarchy is being met.

- A category of the stormwater hierarchy is chosen without proper justification.
- Access to an offsite stormwater discharge location (drainageway, storm sewer, or combined sewer) is not clearly shown.
- Drainageways are not identified and drainage reserves are not delineated.
- Site plan information is inaccurate or inadequate.
- The amount of land required to accommodate stormwater facilities is not accurately shown.
- Conflicts between stormwater facilities and property line or foundation setbacks are shown.
- Disturbance areas are undefined or inaccurate.
- Proposed and existing impervious areas are undefined or inaccurate.

To ensure a timely review, the land use review applicant is strongly encouraged to address these issues before submitting the land use application by following steps 1 through 5 in [Section 2.1.2](#). This information should be included in the Stormwater Management Report and submitted with the land use application.

2.4.3 Simplified Approach Submittal Requirements

The Simplified Approach Form is designed to be used for private development proposals having less than 10,000 square feet of overall impervious area. Each individual tax lot is required to manage the stormwater it generates on the same lot to the maximum extent practicable and within accordance of the *Stormwater Management Manual*. Site conditions may require additional geotechnical or geological evaluation, which may require the Bureau of Environmental Services (BES) to prohibit the use of this Simplified Approach and require the applicant to utilize the Presumptive or Performance approach.

If total impervious area for the submitted development proposal is equal to or greater than 10,000 square feet or includes public or private street improvements, the Presumptive or Performance approach must be used, and a Stormwater Management Report will be required. For more information, refer to [Sections 2.2.2](#) and [2.2.3](#), respectively.

If the proposal is unable to meet the requirements of the *Stormwater Management Manual*, the applicant must submit a Special Circumstances request; refer to the [Section 1.5](#) for more information.

Some stormwater facilities have specific submittal requirements in addition to the design approach requirements. See the facility specific design requirements in [Section 2.3.4](#).

If a site includes proposed encroachments into the drainage reserve or channel, the Drainage Reserve Encroachment Submittal Requirements will also apply (see [Section 2.4.7](#)).

How to prepare a Simplified Approach submittal

No application will be reviewed unless it is complete. All forms must be completely filled in. The minimum submittal requirements include:

- [Simplified Approach Form](#).
- [Tree Credit Worksheet](#) (if tree credit is being utilized).
- Existing conditions site plan.
- Proposed site plan.
- Landscape plans.
- Operation and Maintenance Form and Plan.

Each of these items are described in more detail below.

[Simplified Approach Form](#)

The [Simplified Approach Form](#) must be completely filled out. The form includes tables for the required infiltration testing and instructions on how to perform an open pit test. See [Section 2.3.6](#) for further details about infiltration testing and options. The form also provides the simplified sizing for the facilities. The Simplified Approach Form consists of the following sections:

- Project information.
- Infiltration testing.
- Proposed stormwater facility sizing.

Tree Credit Worksheet

Trees may reduce the size of required stormwater facilities or even eliminate stormwater management requirements on small project proposals. The [Tree Credit Worksheet](#) contains the information needed to apply tree credit to stormwater requirements and consists of the following sections:

- Information on new trees.
- Information on existing trees.
- Information on allowable tree credit.

Site Plans

Existing conditions and proposed site plans. Scaled site plans will include at minimum:

- Minimum scale of 1 inch to 10 feet.
- North arrow.
- Topography and elevations.
- Property lines and lot dimensions.
- Lot area and setbacks.
- Driveways and footprints of structures.
- Wells and septic systems.
- Easements.
- Utility Lines.
- Impervious Areas.
- Type, location, and size of stormwater facilities.
- Type, location, and size of conveyance features (if present or proposed).
- Existing and proposed surface drainage.
- Proposed stormwater discharge location.
- Width of right-of-way and curb height.

Cross-Section and Details of the proposed facility must be included with the plan set. Where sites are topographically varied, it may be imperative to show elevations of inlets, outlets, and discharge locations on the cross-section to show how gravity drainage will be met.

Landscape Plan

Landscape plans are required (see [Section 2.4.1](#)) with all permits that include at least one vegetated stormwater facility. For facility specific requirements including plant density and size requirements see [Section 2.3.4](#).

Operations and Maintenance Form and Plan

The [Operations and Maintenance Form](#) (see [Section 3.1.4](#)) must be recorded with the appropriate County along with the O&M plan (see [Section 3.1.1](#)) prior to permit issuance.

How to submit a Simplified Approach Form and Application

Applications must be submitted concurrently with the development proposal for BES review. Inaccurate or incomplete applications will be returned and will cause a delay in review.

For questions regarding the submittal process, call the BES Development Review Hotline at 503-823-7761.



SIMPLIFIED APPROACH FORM

PROJECT INFORMATION WORKSHEET

PROJECT INFORMATION

Permit Number: _____ Phone: _____

Name: _____ Email: _____

Site Address/R Number(s): _____

Development Description: _____

Total New or Redeveloped Impervious Area: _____

Signature: _____ Date: _____

SITE CHARACTERISTICS

S.1. Do slopes exceed 20% anywhere within the project area? Yes No

S.2. Are there springs, seeps, or a high groundwater table anywhere within the project area? Yes No

If answer to S.1 or S.2 is yes, than lined or partial infiltration facility with an overflow to an approvable discharge point is required.

S.3. Is there a required geotechnical report? Yes No

S.4. Required infiltration testing complete? Yes No

If using prior test results at same site, provide Land Use case/permit number: _____

Required Infiltration Testing

Date of Test: _____

Depth of Excavation (ft): _____

	TEST 1	TEST 2	TEST 3
A. Time (of day)			
B. Duration (hours) (1 hour minimum)			
C. Initial Water Depth (inches)			
D. Final Water Depth (inches)			
E. Infiltration Rate* (inches/hour)			

*Infiltration Rate = Initial Depth (in) – Final Depth (in) / Duration of Test (hours)

SIMPLIFIED INFILTRATION TESTING PROCEDURE

The Simplified Approach provides a method that a nonprofessional can use for design of simple stormwater systems on small projects. A geotechnical report or different infiltration test may be required at the discretion of the assigned BES plan reviewer. See Section 2.3.6 for infiltration testing requirements.

Test instructions:

1. Conduct test in and/or near location of proposed infiltration facility.
2. Excavate a test hole a minimum of 16" in depth, or to the bottom of the proposed infiltration system, whichever is greater. If a hard pan layer is encountered that prevents further excavation, or if noticeable moisture/water is encountered in the soil, stop and measure this depth and note it on the SIM form. If further excavation is not possible, conduct the test at this depth.
3. Fill the hole with water to a depth of at least 6" from the bottom of the hole. Record the amount of time required for the water to draw down to the bottom of the test pit. Check the water level at regular intervals to ensure accurate data collection.
4. Repeat the process two more times for a total of 3 rounds of testing. Conduct the tests in succession to accurately portray the soil's ability to infiltrate at different levels of saturation. The 3rd test provides the best measure of the infiltration rate at saturated conditions.
5. Record infiltration test data in the table at left and certify the results.

Test pit location (site plan sketch)

Key information to include: 1) Site or parcel, 2) Adjacent road(s) or cross street(s), 3) Test pit location with dimensions



Certification of Infiltration Results (required)

I acknowledge the accuracy of these infiltration testing results.

Signature of tester (required)

Print Name

Date

SIMPLIFIED APPROACH FORM

PROPOSED STORMWATER FACILITIES

Proposed Stormwater Facilities

Please note: Each individual taxlot is required to manage the stormwater runoff it generates from new construction or redevelopment on the same lot to the maximum extent feasible. The following table includes accepted simplified stormwater management facilities as described in Chapter 2 of the 2016 Stormwater Management Manual. Copies of the manual are available online at www.portlandoregon.gov/bes/swmm.

	STORMWATER FACILITY TYPE	TOTAL AREA MANAGED BY FACILITY TYPE (SF)	FACILITY SIZING FORMULA	FACILITY SIZE (SF)
IMPERVIOUS AREA REDUCTION TECHNIQUE	Tree Credit		Complete Tree Credit Worksheet and attach	n/a
	Ecoroof		1:1 ratio only	n/a
	Pervious Pavement		1:1 ratio only	n/a
SURFACE INFILTRATION OR FILTRATION	Downspout Extension		Area x 0.10	
	Rain Garden		Area x 0.10	
	Basin		Area x 0.09	
	Swale		Area x 0.09	
	Planter		Area x 0.06	
	Filter Strip (paved areas only)		Area x 0.20	
SUBSURFACE DISPOSAL UIC	Soakage Trench		Westside soakage trench no longer an option under the simplified approach. Only a single soakage trench sizing possible. <i>See below for sizing information.</i>	
	Drywell		Enter drywell type and quantity for facility size. <i>See below for sizing information.</i>	
TOTAL IMPERVIOUS AREA MANAGED			Total Impervious Area Managed must match Total New or Redeveloped Impervious Area. Site plans must identify stormwater facility location, drainage areas, overflows and escape routes.	

Subsurface facilities can receive overflow from impervious area reduction techniques or surface infiltration/filtration facilities or can be used independently to manage runoff. If stormwater is generated from anything other than roof area, stormwater facilities are subject to UIC requirements (see Chapter 1 for UIC requirements).

Sizing Charts:

DRYWELL TYPE	AREA MANAGED
2'x2' mini drywell	Up to 500 sf
28"x5'	Up to 1,000 sf
4'x5'	Up to 3,000 sf
4'x10'	Up to 6,000 sf

SOAKAGE TRENCH	LENGTH PER 1,000 SF OF IA	WIDTH	DEPTH	SIZING
Soakage Trench	20'	2.5'	1.5'	AREA x 0.05

2.4.4 Presumptive Approach Submittal Requirements

The Presumptive Approach is required for sites larger than 10,000 square feet, such as medium- to large-scale residential and commercial projects on either private or public property. The Presumptive Approach is required for private streets and for any project in the public right-of-way. (See [Section 2.2.2](#) for more information.) It can also be applied to size facilities on smaller projects where the more detailed hydrologic calculations will allow the design professional to size a facility more accurately by taking measured infiltration rates and other specific design factors into account. This approach requires the assistance of a licensed engineer or qualified design professional.

If a site includes proposed encroachments into the drainage reserve or channel, the Drainage Reserve Encroachment Submittal Requirements will also apply (see [Section 2.4.7](#)).

How to prepare a Presumptive Approach submittal

No submittal application will be reviewed unless it is complete. The minimum submittal requirements are as follows:

- Existing conditions and Proposed Site Plan.
- Stormwater Management Report (see [Section 2.4.6](#)).
- [Tree Credit Worksheet](#) (if applicable).

[Site Plans](#)

Scaled site plans for existing conditions and proposed site plans must include at a minimum:

- Minimum scale of 1 inch to 10 feet.
- North arrow.
- Topography and elevations.
- Property lines and lot dimensions.
- Lot area and setbacks.
- Driveways and footprints of structures.
- Wells and septic systems.
- Easements.
- Utility Lines.

- Impervious Areas.
- Type, location, and size of stormwater facilities.
- Type, location, and size of conveyance features (if present or proposed).
- Existing and proposed surface drainage.
- Proposed stormwater discharge location.
- Width of right-of-way and curb height.
- All stormwater piping associated with the facility, including pipe materials, sizes, slopes, and invert elevations at every bend or connection.

Cross-Section and Details of the proposed facility must be included with the plan set. Where sites are topographically varied, it may be imperative to show elevations of inlets, outlets, and discharge locations on the cross-section to show how gravity drainage will be met.

Draft Operations and Maintenance Plans

BES must review and approve O&M Forms and Plan prior to permit issuance. For private stormwater facilities and conveyance features, the O&M Form and Plan must be recorded in the County of the subject property. See [Section 3.1.4](#) for private O&M submittal requirements and [Section 3.2.3](#) for public O&M submittal requirements for future BES facilities.

How to submit the Presumptive Approach Requirements

Applications must be submitted concurrently with the development proposal or public improvement for BES review. Inaccurate or incomplete applications will be returned and will cause a delay in review. For questions regarding the submittal process, call the BES Development Review Hotline at 503-823-7761.

2.4.5 Performance Approach Submittal Requirements

If the proposed stormwater management plan meets the intent of all the Stormwater Management Manual requirements, but not as specified under the Simplified or Presumptive Approach, the applicant may submit the project under the Performance Approach. The application must demonstrate that the proposed management plan meets or exceeds all of the City of Portland's stormwater requirements. Refer to [Section 2.2.3](#) for more information about the Performance Approach.

Some stormwater facilities have specific submittal requirements in addition to the design approach requirements. See the facility specific design requirements in [Section 2.3.4](#).

If a site includes proposed encroachments into the drainage reserve or channel, the Drainage Reserve Encroachment Submittal Requirements will also apply (see [Section 2.4.7](#)).

Technical staff under the direction of the Chief Engineer or designee will review Performance Approach submittals. The applicant can initiate a Performance Approach review by submitting a Stormwater Management Report (as specified in [Section 2.4.6](#)). The applicant must provide additional materials and supporting information as requested by city staff to demonstrate how the proposal meets the site-specific stormwater requirements.

How to prepare a Performance Approach submittal

No submittal application will be reviewed unless it is complete. The minimum submittal requirements are as follows:

- Existing conditions and Proposed Site Plan.
- Stormwater Management Report (see [Section 2.4.6](#)).
- [Tree Credit Worksheet](#) (if applicable).

[Site Plans](#)

Scaled site plans for existing conditions and proposed site plans must include at a minimum:

- Minimum scale of 1 inch to 10 feet.
- North arrow.
- Topography and elevations.
- Property lines and lot dimensions.
- Lot area and setbacks.
- Driveways and footprints of structures.
- Wells and septic systems.
- Easements.
- Utility Lines.
- Impervious Areas.

- Type, location, and size of stormwater facilities.
- Type, location, and size of conveyance features (if present or proposed).
- Existing and proposed surface drainage.
- Proposed stormwater discharge location.
- Width of right-of-way and curb height.
- All stormwater piping associated with the facility, including pipe materials, sizes, slopes, and invert elevations at every bend or connection.

Cross-Section and Details of the proposed facility must be included with the plan set. Where sites are topographically varied, it may be imperative to show elevations of inlets, outlets, and discharge locations on the cross-section to show how gravity drainage will be met.

Draft Operations and Maintenance Plans

BES must review and approve O&M Forms and Plan prior to permit issuance. For private stormwater facilities and conveyance features, the O&M Form and Plan must be recorded in the County of the subject property. See [Section 3.1.4](#) for private O&M submittal requirements and [Section 3.2.3](#) for public O&M submittal requirements for future BES facilities.

How to submit the Performance Approach Requirements

Applications must be submitted concurrently with the development proposal or public improvement for BES review. Inaccurate or incomplete applications will be returned and will cause a delay in review. For questions regarding the submittal process, call the BES Development Review Hotline at 503-823-7761.

2.4.6 Stormwater Report Submittal Requirements

A Stormwater Management Report is required for every development proposal or public improvement where the Presumptive Approach or Performance Approach is used. If submitted in hardcopy form, reports should be paginated and securely fastened (including maps and exhibits). If submitted digitally, submit as a single PDF. A Stormwater Management Report must include all of the following items. The Stormwater Management Report must concisely convey the stormwater management plan, including design assumptions.

Cover Sheet

The cover sheet must include the project name, property owner, site address, associated permit numbers, submittal date, and the engineer of record and their full contact information.

Designer's Certification and Statement

The Stormwater Management Report should be certified with the following statement:

"I hereby certify that this Stormwater Management Report for (name of project) has been prepared by me or under my supervision and meets minimum standards of the City of Portland and normal standards of engineering practice. I hereby acknowledge and agree that the jurisdiction does not and will not assume liability for the sufficiency, suitability, or performance of drainage facilities designed by me."

The design professional should stamp and sign the statement with their Oregon registration stamp.

Table of Contents

Provide a table of contents that identifies elements, exhibits, maps, and other information within the Stormwater Management Report.

Project Overview and Description

The project overview must include the size and location of project site (vicinity map), property zoning, type of development or proposed improvements, watershed, permits required (local, state, federal), and existing versus post construction conditions.

Methodology

The Stormwater Management Report must include site specific information and methodologies used to develop the proposed design, including:

- Drainage and conveyance given existing site conditions, including any existing drainageways, description of potential impacts from proposal to existing drainage, and description of techniques for mitigating impacts.
- Infiltration testing results (see [Section 2.3.6](#)).
- Stormwater hierarchy category justification.

- Narrative that describes the proposed stormwater management techniques, including how to meet the site-specific stormwater requirements for infiltration or offsite discharge.

Analysis

The Stormwater Management Report must include:

- Design assumptions used to size stormwater management facilities and conveyance features, such as design storms, computation methods, software used, safety factors, curve numbers, and design coefficients, and clarifying variations from the norm.
- Approved results from the Presumptive Approach Calculator as provided in the PAC Report (see [Appendix A.4](#)).
- Conveyance requirements and design.
- Table of impervious area treated, differentiating between public right-of-way and private stormwater facilities and types of impervious area treated, such as roof or parking lot. See Figure 2-35 as an example. Include areas managed with impervious area reduction techniques, including ecoroofs, pervious paving, and trees.

Figure 2-35. Catchment and Facility Summary

Catchment or Facility ID	IA Type (roof, road)	Impervious Area (sf or ac)	Ownership (private/public)	Facility Type	Facility Size (sf or ac)	CN

- Demonstrate that the project meets any applicable flow control requirements set forth in Section 1.3.4 or 1.3.5 if stormwater is being discharged offsite to Stormwater Hierarchy Categories 3 or 4. The Presumptive Approach Calculator (PAC) Report will provide a summary or see Figure 2-36.

Figure 2-36. Pre vs. Post Construction Flow Rates

Catchment ID	Peak Flow Rate (CFS)								Time of Concentration	
	2 yr		5 yr		10 yr		25 yr		Pre	Post
	Pre	Post	Pre	Post	Pre	Post	Pre	Post		

- Determination of the escape route or inundation level for the 24-hour 100-year event.

Engineering Conclusions

Based on compliance with the Stormwater Management Manual, determine how the site-specific stormwater requirements are met, including any flow control or water quality requirements.

Stormwater Facility Details/Exhibits

Include grading plans of pre and post-development, impervious area identification, watershed, existing and new drainageways, and any offsite discharge locations. Delineate each catchment (area treated by a single stormwater facility) and identify any stormwater conveyance features. A Landscape Plan is required for all projects that include at least one vegetated stormwater facility (see [Section 2.4.1](#); for facility-specific planting requirements, see [Section 2.3.4](#)).

2.4.7 Drainage Reserve and Channel Encroachment Submittal Requirements

Drainage reserves are typically 30 feet in width (15 feet from the centerline of the channel on both sides). On sites with drainage reserves, encroachments into either the drainage reserve (within 5 feet of the outer reserve edge) or the drainageway channel (within 10 feet of the centerline of the channel itself) may be allowed if approved by BES. Design criteria for drainage reserves are in [Section 2.3.4.20](#); design criteria for reserve encroachments are in [Section 2.3.4.21](#); and design criteria for channel encroachments are in [Section 2.3.4.22](#).

How to prepare a drainage reserve encroachment or a channel encroachment submittal

No submittal will be reviewed unless it is complete. It is critical that information provided be clear, concise, accurate, and complete. A complete submittal consists of the following elements:

- Site plans including topography and grading for both existing conditions and proposed conditions.
- Compliance with drainage reserve conveyance requirements.
- Construction Management Plan (including erosion control plan).
- Landscape Plan.
- Operations and Maintenance Form and Plan.

A number of these elements can be combined with submittal requirements for the required design-specific approach (See [Section 2.4](#) and [Chapter 3](#)).

Site Plans

In addition to the site plan requirements for the design-specific approach, the following information must be included for existing and proposed site conditions.

For development sites that are less than 10,000 sf a survey of the existing conditions is required to delineate the drainage reserve.

Existing Conditions Site Plan

- Indicate location of the surveyed centerline of the drainageway, both natural and man-made. The limits of the identified drainageway must be clearly delineated.
- Provide 1' contours within the area of disturbance.
- Indicate the location of all surveyed cross sections.
 - A minimum of three surveyed cross-sections of the drainage reserve are required: where the drainage reserve enters and exits the property, and at the location(s) of the encroachment(s). Additional surveyed cross-sections are required at points of significant change and configuration (e.g. grade or size of channel).
 - Development sites that are greater than 10,000 sf will require the delineation of all drainageways within the disturbance area. If a drainageway is not within the disturbance area, drainage reserves will be placed but not delineated and the estimated location will be noted on the Operations and Maintenance site plan.
- Indicate the location of 30-foot wide drainage reserve. The standard drainage reserve is 15 feet from the drainageway centerline.

- Indicate existing structures and/or impervious area within the disturbance area or drainage reserve.
- Indicate existing trees greater than six inches in diameter at breast height (DBH) by size and species within the disturbance area or drainageway including within the drainage reserve.

Proposed Site Plan

- Indicate the type of proposed encroachment (reserve encroachment or channel encroachment).
- Indicate the proposed cross-section of the drainage reserve at the encroachment or proposed channel.
- Indicate the location of the proposed centerline of the drainageway. If a pipe/culvert is proposed, show a cross-section and profile including diameter, depth, slope, type and invert elevation of the pipe/culvert. The profile should extend as far as necessary to go beyond hydraulic effects caused by the crossing.
- Indicate a long-profile of the drainageway including the calculated average channel slope.
- Indicate the proposed changes to the drainage reserve.
- Indicate the location of proposed development activity, disturbance area (temporary and permanent), and staging area (including utilities).
- Indicate the location of existing trees and trees proposed to be removed greater than six inches diameter at breast height by size and species within the disturbance area or within the drainage reserve.
- Indicate the type, location, and size of the stormwater facility(s) discharging to the drainage reserve and the location of the proposed stormwater discharge location.
- Indicate the cross-section and plan view of the discharge location.

Compliance with drainage reserve conveyance requirements

For drainage reserve encroachments, a mitigation plan must be submitted that includes:

- A narrative discussing how the encroachment has been minimized to the maximum extent possible.

- An estimation of the flow impacts to the drainageway, including decreases in flow conveyance volume, flow path alteration, or any structure that could cause flow ponding
- Calculation and channel cross-sections to demonstrate proposed conveyance capacity.
- Documentation of restoration of the temporary disturbance area and any mitigation proposed using vegetation that must meet or exceed vegetation requirements indicated in [Section 2.3.4.21](#).

For channel encroachments, a Stormwater Management Report must be used to demonstrate how conveyance capacity requirements will be met. The Stormwater Management Report (see [Section 2.4.6](#)) must include a map of the delineated basin area along with the following:

[Engineering Analysis for Open Channel Drainageway](#)

For a proposed open channel drainageway, the applicant must provide an engineering analysis documenting that the drainageway is adequately designed, including:

- Hydrology calculations estimating flow volumes for the 2-year, 25-year and 100-year events.
- A downstream hydraulic analysis in order to demonstrate adequate capacity for the proposed development and the existing basin.
- Demonstrate adequate conveyance. Open channel systems are required to convey the 25-year storm within the drainage reserve and cannot cause increased flooding to buildings or other infrastructure during the 100-year design storm. Floodplain and overbank areas should be included in conveyance capacity calculations.
- Cross sections and elevations of the drainageway and delineation of the drainage basin. Cross sections should include existing and proposed sections as appropriate.
- Upgrades and improvements to the downstream system may be necessary to accommodate flow from the proposed development.
- Drainage Reserve review would be required for any future encroachments or enhancements to the drainageway.
- Licensed engineer stamped calculations and plans.

Engineering analysis for proposed pipes or culverts (if applicable)

For a proposed pipe or culvert, the applicant must provide an engineering analysis documenting the pipe is sufficiently sized, including:

- The applicant must submit stamped and/or signed engineering calculations that substantiate the proposed pipe will provide the needed capacity for the drainage basin area. Calculations must account for existing drainage and address downstream impacts.
- Culvert sizing should account for sediment transport and fish passage (where required).

Construction Management Plan

A construction management plan (including an erosion control plan) must include the following elements:

- Provide a narrative indicating a construction management plan for existing drainageways and during proposed modifications of the drainageways.
- Provide a construction staging and access plan showing staging areas and access paths. Provide construction exclusion fencing to preserve undisturbed areas.
- Indicate how the drainage reserve area will be protected during development of the site.
- Submit a development schedule that notes any seasonal development limitations for drainageway protection.
- State and federal agencies may impose an in-water work window.
- Identify how drainageways on the site will be protected during construction (including exclusionary fencing to prevent encroachment and protect drainageways from soil stockpiles, backfill, construction debris, construction equipment, etc.) and how disturbed soil will be permanently stabilized.
- Provide a temporary diversion plan if the channel will be blocked.

Erosion Control Plan

- Provide a narrative indicating erosion control measures for protecting drainageways and the area downstream.
- Erosion control measures during work within the drainage reserve area.
- Erosion control measures after work within the drainage reserve is complete and work on proposed structures is ready to begin.

- Identify temporary and permanent erosion control measures, including details as necessary, in the Erosion Control Plan.

Landscape Plan

Any plan for permanent landscape within the drainage reserve area must have a landscaping plan. Native plants are required in drainage reserves when mitigating for any proposed encroachments. For planting recommendations see the [Portland Plant List](#).

Specific requirements for plant density and size requirements can be found in [Section 2.3.4.21](#). Information the Landscape Plan is located in [Section 2.4.1](#).

Operations and Maintenance Plan

An Operations and Maintenance Plan (O&M) is required for a permitted improvement or encroachment to a drainage reserve. Operations and Maintenance Plans must be recorded with an O&M Form in the County of the subject property. An O&M plan for drainage reserve encroachments is located in [Section 3.1.3](#). Information on how to submit an O&M Form is located in [Section 3.1.4](#).

How to submit a Drainage Reserve Encroachment or a Channel Encroachment for review

The request for a drainage reserve encroachment must be submitted concurrently with the development proposal for BES review. Inaccurate or incomplete applications will be returned and will cause a delay in review.

For questions regarding the submittal process, call the BES Development Review Hotline at 503-823-7761.

2.4.8 Manufactured Stormwater Treatment Technology Submittal Requirements

This section outlines the submittal requirements and review process for vendors/manufacturers of proprietary treatment systems who seek to be on the City of Portland's list of approved devices.

The current list of approved manufactured stormwater treatment technologies is online at www.portlandoregon.gov/bes/swmm.

Introduction

The City of Portland maintains a list of approved manufactured stormwater treatment technologies that can be used under the Stormwater Management Manual Performance Approach. Manufacturers of stormwater treatment technologies who seek to be on the approved list must apply and follow these

submittal requirements. The approval process evaluates the manufactured stormwater treatment technology for its effectiveness in meeting the pollution reduction requirements of the *Stormwater Management Manual* and Portland City Code 17.38.

Engineers or qualified design professionals who wish to use manufactured stormwater treatment technologies not on the approved list must use the Performance Approach for a specific site development or improvement proposal. Approvals under the Performance Approach are site specific and do not imply any wider approval or precedent.

The Washington State Department of Ecology (DOE) Technology Assessment Protocol (TAPE) is a standard method by which many Northwest municipalities evaluate and approve manufactured stormwater treatment technologies for use in their communities. The City of Portland requires that manufactured stormwater treatment technologies must have a current general use level designation (GULD) by Washington State DOE under TAPE prior to application and review to the City of Portland. The Bureau of Environmental Services (BES) has decision-making authority to approve, deny, or revoke the use of manufactured stormwater treatment technologies within the City of Portland at any time, regardless of previous certification by DOE or prior approval by BES.

TAPE (Technology Assessment Protocol – Ecology)

Washington State Department of Ecology evaluates treatment technologies through TAPE. An overview of the process, submittal requirements, and a list of DOE approved technologies are online at:

<http://www.ecy.wa.gov/programs/wq/stormwater/newtech/index.html>

Performance Criteria

Applicants (including, but not limited to, manufacturers, product vendors, consultants or any other person promoting the manufactured stormwater treatment technology) should ensure that the manufactured stormwater treatment technology meets Portland’s pollution reduction requirements. The Stormwater Management Manual includes the following pollution reduction requirements:

Total Suspended Solids

The pollution reduction performance goal for the City is 70 percent removal of total suspended solids (TSS) from 90 percent of the average annual runoff (see Section 1.3.4).

Total Maximum Daily Load and 303(d) Listed Parameters

Certain watersheds within the City of Portland have established Total Maximum Daily Loads (TMDLs). The TMDLs apply specific pollution control requirements to designated pollutants of concern. To ensure that new development does not contribute pollutants of concern to a TMDL watershed, pollution reduction facilities are required to demonstrate specific removal rates for those specific pollutants. See Exhibit 1-5 in Section 1.3.4 of the Stormwater Management Manual for a current list of TMDL watersheds with corresponding pollutant parameters. TSS may be used as a surrogate for aldrin, chlordane, DDE, DDT, dieldrin, dioxin, and PCBs.

Application Process

Applicants seeking BES approval of manufactured stormwater treatment technologies must submit an application form, a cover letter, all required documentation, and an application fee. The review process consists of a public presentation about the manufactured stormwater treatment technology, a technical interview, and third-party review of the documentation.

The application form, application fee, and cover letter should be submitted to:

City of Portland, Environmental Services
ATTN: Engineering Services Support Program Manager
1120 SW 5th Ave., Suite 1000
Portland, OR 97204

All other required documents should be submitted digitally: one set of PDF file(s), and one set of native files if available in standard format. For example, if analysis or data tracking was done using Excel, submit the original Excel files. All data and documentation necessary to verify performance must be included in the application. BES may request additional documentation or data during the review process.

BES will provide a single point of contact for applicants that will facilitate and track the application process. All correspondence and communication with the City of Portland regarding the application must be through the single point of contact. BES will review one complete application at a time in the order received. BES will convene a Review Committee that will attend the public presentation and the technical interview, review the application and the third-party review evaluation, determine any conditions of use, and maintain the list of approved manufactured stormwater treatment technologies. Following submission of a complete application, BES will provide the Applicant with a list of Review Committee members and single point of contact for any questions or coordination needs.

Required Submittals

Applicants must submit all of the following documents. Submitting an application does not guarantee that BES will approve a manufactured stormwater treatment technology. BES will review only manufactured stormwater treatment technologies that have achieved TAPE GULD certification.

All information provided to the City must be public record and subject to public disclosure pursuant to Oregon public record laws (ORS 192.410 to 192.505). Any portion of an application that the applicant claims as exempt from disclosure must meet the requirements of ORS 192.501(2) and ORS 192.502(4) and/or ORS 646.461 et seq. In order for such information to be considered exempt from public disclosure, the applicant must certify that the information is unique to the design and construction of the technology, or release to the public or to a competitor would adversely affect the competitive position of the proponent. All monitoring data including, but not limited to, laboratory results and field measurements, QA/QC data, data qualifiers, and monitoring site information cannot be considered confidential.

The applicant must mark only those pages that contain information exempt from public disclosure with the word “confidential” and provide a letter of explanation as to why these pages are exempt from public disclosure. The fact that an applicant marks information as exempt from disclosure does not mean that the information is necessarily exempt. Review of information exempt from public disclosure will be limited to the Review Committee and the Third Party Review.

Application Form

Applicants must submit a Manufactured Stormwater Treatment Technology Application Form. Applicants must complete the form in full.

Application Fee

Applicant must pay the application fee at the time of application submission. Checks must be made out to the City of Portland. The fee will cover costs of the third-party evaluation as well as City staff time to process, coordinate, and review the application. The current fiscal year’s application fee is shown on the application form.

Cover Letter

The cover letter must be a single page and include the following:

- The name of the device with a short description of its intended application within the City of Portland.
- A summary of the TAPE history for the device, including the date of achieving GULD certification.
- A summary of the treatment performance goals, specific land uses, and targeted pollutants for which the device received TAPE certification.
- The signature of a company representative authorized to submit the application.

TAPE Documentation

All final documentation used to achieve TAPE GULD certification from Washington State DOE. This includes:

- Technology Evaluation Report (TER), including appendices and any third party review memorandum.
- Quality Assurance Project Plan (QUAPP), including any appendices.
- The most recent General Use Level Designation provided by DOE.

Submit TAPE documentation to BES as it was submitted to Washington State DOE. Do not re-order or otherwise modify the TER or QUAPP. If the TAPE documentation does not clearly demonstrate compliance with Portland's required pollution reduction standards, provide additional testing plus analysis. If the TAPE GUILD approval was dependent on increased sizing or reduced treatment flow rates, provide that justification and analysis. If TAPE GULD certification required post-installation maintenance analysis, provide that as supplemental information.

Design Information

Submit standard details for all configurations, orientations, and bypass options under consideration. If there are unit components that have different sizing criteria, provide criteria and sizing for all unit components. Provide flow-based sizing to meet Portland's pollution reduction requirements (including any sizing assumptions or requirements as per the TAPE GULD certification) for a units' receiving drainage area (square feet or acre). If unit is inclusively designed for volume-based sizing,

provide that as well, as measured in a unit's receiving drainage area (square feet or acre).

References

Provide references for at least two public agencies who have had installations in the public right-of-way installed for at least two years. The references should be from public works departments or other stormwater operations and maintenance departments who have knowledge and experience with maintenance activities and inspection frequencies.

Additional Product Information

If installation guides, maintenance guides, or recommended plant lists have been updated since GULD designation, provide the most recent information. Provide current marketing material for only the MSTT under consideration.

BES Evaluation Process

Following application submittal to BES, BES will review and determine if the application is complete. After BES deems an application complete, the presentation and interview should be scheduled within 30 business days.

[Public Presentation and Technical Interview](#)

BES will work with the applicant, the Review Committee, and third-party reviewers to arrange a public presentation of the proposed manufactured stormwater treatment technology. At the conclusion of the presentation, there will be a technical interview of the applicant about the proposed manufactured stormwater treatment technology. The interview will not be open to the public and will consist only of the Review Committee, third-party reviewers, and the applicant.

BES staff will make reasoned decisions about manufactured stormwater treatment technologies and their application in the Portland metro area based on “best professional judgment” of the evidence provided. The TER, submitted as part of the TAPE process, will be critical to understanding the applications and characteristics of the technology and how it will be used in Portland, Oregon. The applicant should be prepared to respond to each of the key sections of the TER as they are applicable to the Portland area. Applicants should also be prepared to discuss or provide local or regional examples of operation and maintenance of systems by public agencies and/or private entities.

Third-Party Review

Following the public presentation and technical interview, the third-party review should be complete within 90 business days. BES will engage a consultant or academic institution to evaluate the manufactured stormwater treatment technology for use within the City of Portland. The third-party review will compare the data used to achieve GULD certification against the pollution reduction requirements for the City of Portland as identified in City Code 17.38 and the Stormwater Management Manual. The third-party review will evaluate whether the manufactured stormwater treatment technology meets Portland's pollution reduction requirements. The third-party review will evaluate water quality data and storm event intensity.

BES Review Determination

BES will make a final decision of approval or denial within 30 business days following completion of a third-party review. BES has decision-making authority for approval of manufactured stormwater treatment technologies for use within the City of Portland and may place conditions of approval to provide consistency with local zoning or land use requirements, or to meet watershed-specific water quality requirements. Conditions may include, but are not limited to, maximum flow rates, limitations on drainage basin size, or installation locations.

BES may at any time suspend or revoke approval of a manufactured stormwater treatment technology if the performance of the technology does not meet the approval performance criteria, or if the performance criteria changes due to local, state, or federal pollution reduction requirements.

Appeals

If the applicant does not agree with the outcome or conditions of the evaluation process, the applicant may request an Administrative Review, as per [Section 1.6](#).

Renewal Process

Manufactured stormwater treatment technologies will be approved for 36 months from the date of approval. If no changes to the manufactured stormwater treatment technology occur (such as, but not limited to, dimensional changes to the physical device, changes to the filtration media, changes to maintenance requirements, or changes in expected performance or device design criteria), the approval can be renewed. At the end of the approval period, the applicant may notify BES of their intent to renew their approval for a subsequent 36 months. If any changes, updates or revisions, have occurred to the manufactured stormwater treatment technology, the applicant must obtain TAPE GULD certification and re-

apply following the submission guidelines in effect at the time of application, including fee payment.

To renew approval of a manufactured stormwater treatment technology, the applicant must submit an application form noting the intent to renew an existing approved manufactured stormwater treatment technology. There is no cost to renew an existing approval. The renewal will begin on the date that BES determines the renewal form is complete.

If an applicant submits a renewal request and the pollution reduction requirements or the evaluation criteria have changed since the original approval, BES may require the applicant to re-apply.



CITY OF PORTLAND
Stormwater
Management
Manual

MANUFACTURED STORMWATER TREATMENT TECHNOLOGY APPLICATION FORM

Applicants applying for approval of manufactured stormwater treatment technologies must meet the submission guidelines and evaluation requirements in Section 2.4.8 of the *Stormwater Management Manual*. The Bureau of Environmental Services (BES) requires that a manufactured stormwater treatment technology has a general use level designation through the Washington State Department of Ecology Technology Assessment Program.

Applicants requesting review of a **new application** must submit all of the required application materials in order for their application to be considered complete. Applicants must submit one set of digital files of all required items and data.

Applicants requesting **renewal of an existing approval** should complete this form and submit to BES, but do not need to re-submit materials or the application fee.

(for Environmental Services use only)

Evaluation milestones

Date Received: _____

Date of Presentation: _____

Date Delivered to TPR: _____

Date Due to BES: _____

Tracking Number: _____

Date of Request: _____

APPLICANT INFORMATION

Contact Name: _____

Company Name: _____

Address: _____

Phone: _____

Email: _____

Website: _____

TECHNOLOGY INFORMATION

Name of Technology: _____

Manufacturer: _____

Brief Description:

THIS APPLICATION IS A:

- New application
- Renewal of an existing approval

REQUIRED APPLICATION MATERIALS

- Application Fee (\$8,000)
- Cover Letter
- TAPE Documentation
- Design Information
- References
- Additional Product Information

All applications and payments should be submitted to:

ATTN: Engineering Services Support Manager
Bureau of Environmental Services
City of Portland
1120 SW 5th Ave., Room 1000
Portland, OR 97204-1972

Chapter 3. OPERATIONS AND MAINTENANCE

This chapter establishes operations and maintenance (O&M) requirements for the stormwater management facilities and conveyance features implemented or protected through the requirements of the *Stormwater Management Manual*. O&M requirements for stormwater facilities and conveyance features on private property are presented in [Section 3.1](#). Requirements for public stormwater facilities, either in the public-right-of-way or otherwise publicly owned, are presented in [Section 3.2](#).

3.1 Operations and Maintenance Requirements for Private Property	3-3
3.1.1 Simplified and Presumptive Approach Maintenance Requirements	3-4
3.1.1.1. Ecoroofs	3-5
3.1.1.2. Pervious Pavement	3-7
3.1.1.3. Trees.....	3-9
3.1.1.4. Downspout Extensions	3-11
3.1.1.5. Rain Gardens.....	3-13
3.1.1.6. Swales	3-15
3.1.1.7. Curb Extensions	3-17
3.1.1.8. Planters	3-19
3.1.1.9. Basins	3-21
3.1.1.10. Filter Strips (Vegetated Filters)	3-23
3.1.1.11. Drywells and Soakage Trenches	3-25
3.1.2 Performance Approach Maintenance Requirements.....	3-26
3.1.3 Stormwater Conveyance Features.....	3-34
3.1.3.1. Drainageway and Drainage Reserves	3-35
3.1.3.2. Drainage Reserve or Channel Encroachment	3-36
3.1.3.3. Culverts	3-37
3.1.3.4. Outfalls.....	3-38
3.1.4 Private O&M Submittal Requirements	3-39

- 3.2 Operations and Maintenance Requirements for Future Public Facilities 3-45
 - 3.2.1 Establishment and Maintenance Requirements 3-46
 - 3.2.1.1. Green Street Facilities 3-47
 - 3.2.2 Manufactured Stormwater Treatment Technologies..... 3-50
 - 3.2.3 Submittal Requirements for Future BES Facilities 3-51

3.1 Operations and Maintenance Requirements for Private Property

Onsite stormwater systems, including stormwater management facilities and conveyance features, must be maintained so they function as intended and limit offsite environmental impacts. Owners are required to check their stormwater systems regularly to determine maintenance needs. Routine inspection and maintenance can help keep overall maintenance costs at a minimum by detecting problems early and avoiding large repair or replacement costs. Per the requirements in [Chapter 1](#), operations and maintenance requirements are laid out in an Operations and Maintenance (O&M) Plan.

The key goals for any O&M plan are to:

- Relay information between the designer/engineer and those providing maintenance.
- Identify the onsite stormwater system that's required or impacted by development. Elements include the stormwater management facilities, runoff sources, discharge locations, and stormwater conveyance features such as drainageway and related encroachments, pipes, storm sewers, culverts, and outfalls.
- Provide long-term guidance to prevent system deterioration and failure.
- Define the visual indicators of diminished performance and maintenance requirements for each stormwater management facility and conveyance feature that comprises the onsite stormwater system.
- Provide a schedule for inspection and maintenance to maintain and restore optimal performance.
- Designate property owners or other parties responsible for O&M of the onsite stormwater management system.
- Require inspection and maintenance logs to be filled out by maintenance personnel and kept by the responsible parties.

Stormwater facilities, including associated paths, gates and covers, must be maintained to provide safe, efficient access for maintenance.

Every project on private property with one or more stormwater facilities or conveyance features must submit an [Operations & Maintenance \(O&M\) Form](#) provided in [Section 3.1.4](#). The [O&M Form](#) identifies the site and property owner, the parties responsible for O&M activities, and stormwater facility information. The [O&M Form](#) also provides a space for a simple site plan. If the space is not sufficient for a drawing of the stormwater management system, including conveyance features, a site plan must be attached. The Bureau of Environmental Services may require a more detailed site plan

for plan review if the simple site plan does not clearly identify stormwater facility location and types.

Operations and maintenance requirements will vary, based on how the facility is designed and if there are natural or constructed conveyance features.

- The submittal for stormwater management facilities designed with the Simplified or Presumptive Approach must include the standard O&M plan provided in [Section 3.1.1](#). Every facility type used must be represented by the standard O&M plan for that facility type.
- The submittal for stormwater management facilities designed with the Performance Approach must include a site-specific O&M Plan as presented in [Section 3.1.2](#).
- The submittal for natural or constructed conveyance features such as drainageways, drainage reserves, drainage reserve easements, culverts, or outfalls must include the appropriate O&M plan provided in [Section 3.1.3](#). This is in addition to the stormwater management facility requirements, which are specific to the design approach.

Submittal requirements for private property and the [O&M Form](#) are found in [Section 3.1.4](#).

3.1.1 Simplified and Presumptive Approach Maintenance Requirements

When the Simplified or Presumptive Approach is used to design stormwater management facilities, the required O&M submittal to BES is:

- A Standard O&M Plan for each facility type included in the permitted development;
- A completed [O&M Form](#) that has been recorded with the appropriate county. A Site Plan (either sketched or attached) must be included.

The property owner or responsible party must keep a copy of the recorded [O&M Form](#) and the appropriate O&M plans. Operations and maintenance practices must be consistent with the version of the Stormwater Management Manual that was in effect when the original [O&M Form](#) was filed, or consistent with the most current O&M practices and guidance for the facilities. The property owner is responsible for ensuring that the maintenance is completed and records are kept, even if someone other than the property owner is performing the maintenance, such as a facility manger or maintenance company.

The following Standard O&M plans are for facilities designed with the Simplified and Presumptive Approaches.

STANDARD O&M PLAN FOR THE SIMPLIFIED APPROACH

3.1.1.1. Ecoroofs

Note: If the installed ecoroof is a proprietary system, then the O&M requirements for the system supersede this plan.

Structural components, including the waterproof membrane, must be operated and maintained in accordance with the manufacturer's specifications and design specifications.	
MAINTENANCE INDICATOR	CORRECTIVE ACTION
Clogged drains	Remove sediment and debris if necessary.
Tears or perforation of membrane	Repair any leaks or structural deficiencies; contact manufacturer for repair or replacement.
Vegetation must cover at least 90% of the facility at maturity.	
MAINTENANCE INDICATOR	CORRECTIVE ACTION
Dead or stressed vegetation	Replant per original planting plan, or substitute from the plant list in Section 2.4.1 .
Dry grass or other plants	Trim dry grasses and remove clippings.
Weeds	Manually remove weeds before they go to seed.
Growing medium must sustain healthy plant cover and drain within 48 hours.	
MAINTENANCE INDICATOR	CORRECTIVE ACTION
Exposed soil	Cover with plants and mulch as needed.
Eroded soils and gullies	Fill, hand tamp, or lightly compact and plant to disperse flow.
Crusting, dry, or shrinking medium	Rake or amend to restore infiltration or flow.
Ponding or excessive moisture	Amend soils and clear drains. Check irrigation system for leaks.

Annual Maintenance Schedule

Summer	Make necessary repairs. Improve growing medium as needed. Irrigate as needed.
Fall	Replant areas of exposed soil, replace dead plants. Provide erosion control for bare soil.
Winter	Monitor infiltration/flow-through rates.
Spring	Replant areas of exposed soil and replace dead plants
All seasons	Weed as necessary. Clean drains as necessary.

Maintenance Records: All facility operators are required to keep an inspection and maintenance log. Record date, description, and contractor (if applicable) for all repairs, landscape maintenance, and facility cleanout activities. Keep work orders and invoices on file and make available upon request of the City inspector.

Fertilizers/Pesticides/Herbicides: Their use is strongly discouraged because of the potential for negative impacts to downstream systems. If pesticides or herbicides are required, use the services of a licensed applicator and products approved for aquatic use.

Irrigation: During the establishment period (up to 3 years), irrigation must not exceed ½ inch of water every 10 days, regardless of water source. Post-establishment irrigation must not exceed ¼ inch of water every 14 days (May through October), regardless of water source. Consider installing an irrigation flow meter for ecoroofs greater than 5,000 square feet. Test the irrigation system for leaks annually. Make sure irrigation piping is covered by at least 2" of soil at all times.

Infiltration/Flow Control: Ecoroofs must drain within 48 hours. Record time/date, weather, and site conditions when ponding occurs.

Pollution Prevention: All sites must implement Best Management Practices to prevent the introduction of pollutants into stormwater. Record the time/date, weather, and site conditions when site activities contaminate stormwater. Record the time/date and description of corrective action taken.

Vectors (Mosquitoes and Rats): Ecoroofs must not harbor mosquito larvae or rodents that pose a threat to public health or that undermine the facility structure. Record the time/date, weather, and site conditions when vector activity observed. Record when vector abatement started and ended.

Operations and Maintenance Log

Date	Work Performed By	Type of Work Performed			Notes	Initials
		Plant Replacement type, location	Structural Repairs – type, location	Other		

STANDARD O&M PLAN FOR THE SIMPLIFIED APPROACH

3.1.1.2. Pervious Pavement

Note: If this is a proprietary system, the O&M requirements for the system supersede this plan.

Structural components, including surface materials, must evenly infiltrate stormwater.	
MAINTENANCE INDICATOR	CORRECTIVE ACTION
Clogged surface	Vacuum or dry sweep at least once a year.
Unraveling or settled pavement	Repair as per manufacturer specification. Do not apply sealants to pervious pavement.
Vegetation must be managed to reduce impacts to pervious pavement.	
MAINTENANCE INDICATOR	CORRECTIVE ACTION
Leaf debris	Sweep leaf litter and sediment to prevent surface clogging and ponding.
Vegetation encroachment	Prevent large root systems from damaging subsurface structural components.
Weeds	Manually remove, mow, or torch weeds.
Filter medium must be maintained to preserve infiltration capacity.	
MAINTENANCE INDICATOR	CORRECTIVE ACTION
Aggregate loss	Replace paver pore space with aggregate per original design.

Annual Maintenance Schedule

Summer	Make structural repairs.
Fall	Vacuum sweep.
Winter	Monitor infiltration rates.
Spring	Vacuum sweep.
All seasons	Weed as necessary.

Maintenance Records: All facility operators are required to keep an inspection and maintenance log. Record date, description, and contractor (if applicable) for all repairs, landscape maintenance, and facility cleanout activities. Keep work orders and invoices on file and make available upon request of the City inspector.

Access: Maintain ingress/egress per design standards.

Infiltration/Flow Control: All facilities must drain within 48 hours. Record time/date, weather, and site conditions when ponding occurs.

Pollution Prevention: All sites must implement Best Management Practices to prevent the introduction of pollutants into stormwater. Record the time/date, weather, and site conditions when site activities contaminate stormwater. Record the time/date and description of corrective action taken.

Vectors (Mosquitoes and Rats): Stormwater facilities must not harbor mosquito larvae or rodents that pose a threat to public health or that undermine the facility structure. Record the time/date, weather, and site conditions when vector activity observed. Record when vector abatement started and ended.

Operations and Maintenance Log

Date	Work Performed By	Type of Work Performed	Notes	Initials

STANDARD O&M PLAN FOR THE SIMPLIFIED AND PRESUMPTIVE APPROACHES

3.1.1.3. Trees

Trees must be maintained per the approved plan.	
MAINTENANCE INDICATOR	CORRECTIVE ACTION
Dead or stressed tree	<ul style="list-style-type: none"> • Replant per original planting plan, or substitute from the plant list in Section 2.4.1. • Irrigate as needed. • Mulch or amend soil as needed. • Prune branches and dead limbs and remove clippings. • Manually remove weeds. Do not use pesticides.

Annual Maintenance Schedule

All seasons	Mulch or amend soil as needed. Prune tree as necessary to protect sight lines. Irrigate and weed as needed. Inspect trees for damage and disease.
-------------	---

Maintenance Records: All facility operators are required to keep an inspection and maintenance log. Record date, description, and contractor (if applicable) for all landscape maintenance. Keep work orders and invoices on file and make them available upon request of the City inspector.

Planting and Irrigation: Consult Portland Parks and Recreation’s website (“Urban Street Tree Planting Standards”) for guidance about planting and irrigation. Irrigation is required during the establishment period to ensure tree survival. Hand watering is preferred, but a drip irrigation system may also be used. Long-term irrigation is not required.

Pruning: Pruning is allowed only for safety reasons and the health of the tree; however, pruning is allowed adjacent to a building if it is needed to protect the structure. Consult Portland Parks and Recreation’s website for information about permit requirements for pruning.

Tree Removal: Trees must be maintained and protected after construction and for the life of the development (50 to 100 years or until any approved redevelopment occurs). During the life of the development, trees approved for stormwater credit must not be removed without approval from BES and approval may be required by Portland Parks and Recreation’s Urban Forestry group. Trees that are removed or die must be replaced within 6 months with like-species or alternatives approved by BES.

Vectors (Mosquitoes and Rats): Trees must not harbor mosquito larvae or rodents that pose a threat to public health or that undermine the structure of the facility. Contact the county vector control group for guidance.

Operations and Maintenance Log

Date	Work Performed By	Type of Work Performed	Notes	Initials

STANDARD O&M PLAN FOR THE SIMPLIFIED APPROACH

3.1.1.4. Downspout Extensions

Structural components must be operated and maintained in accordance with the design specifications.	
MAINTENANCE INDICATOR	CORRECTIVE ACTION
Clogged gutters, drains, or downspouts	Remove sediment, debris, and blockages from downspouts, gutters, and pipes to maintain at least 50% conveyance at all times. Cleaning twice a year or more is recommended depending on the presence of overhanging trees.
Damaged or missing pipes, gutters, and downspouts	Repair or replace broken gutters and downspouts as needed. Identify possible leaks and verify that roof flashing directs water into gutters. Look for low spots or sagging areas along the gutter line and repair as needed with new hangers.
Blocked downspout extension	Clear downspout elbows of debris. Clear any build-up of soil, bark dust, and/or vegetative growth from around downspout extensions and/or splash blocks. Verify there is sufficient slope so water flows away from the foundation.
Vegetation	
MAINTENANCE INDICATOR	CORRECTIVE ACTION
Dead or stressed vegetation	Replant per original plan, or substitute from the plant list in Section 2.4.1 .
Dry grass or other plants	Irrigate and mulch as needed. Maintain grass height at 6"-9".
Weeds	Manually remove weeds.
Growing medium must sustain healthy plant cover and infiltrate within 48 hours.	
MAINTENANCE INDICATOR	CORRECTIVE ACTION
Gullies, erosion, exposed soils, sediment	Fill in and lightly compact areas of erosion with City-approved soil mix (see Section 2.3.6) and replant according to planting plan or substitute from the plant list in Section 2.4.1 . Any erosion deeper than 2" must be addressed. Sediment deeper than 4 inches must be removed.
Scouring at the inlet(s)	Ensure splash blocks or inlet gravel/rock are adequate.

Annual Maintenance Schedule

Summer	Make structural repairs. Clean gutters and downspouts. Remove any build-up of weeds or organic debris.
Fall	Replant exposed soil and replace dead plants. Remove sediment and plant debris.
Winter	Clear gutters and downspouts to maintain conveyance.
Spring	Remove sediment and plant debris. Replant exposed soil and replace dead plants.
All seasons	Weed as necessary.

Maintenance Records: All facility operators are required to keep an inspection and maintenance log. Record date, description, and contractor (if applicable) for all repairs, landscape maintenance, and cleaning activities. Keep work orders and invoices on file and make them available upon request by the City inspector.

Infiltration/Flow Control: All facilities must drain within 48 hours. Record time/date, weather, and site conditions when ponding occurs.

Pollution Prevention: All sites must implement best management practices to prevent the introduction of pollutants into stormwater. Record the time/date, weather, and site conditions when site activities contaminate stormwater. Record the time/date and description of the corrective action taken.

Vectors (Mosquitoes and Rats): Stormwater facilities must not harbor mosquito larvae or rodents that pose a threat to public health or that undermine the facility structure. Record the time/date, weather, and site conditions when vector activity is observed. Record when vector abatement started and ended.

Operations and Maintenance Log

Date	Work Performed By	Type of Work Performed				Notes	Initials
		Sediment and Trash Removal	Plant Replacement type, location	Structural Repairs – type, location	Other		

STANDARD O&M PLAN FOR THE SIMPLIFIED APPROACH

3.1.1.5. Rain Gardens

Structural components must be operated and maintained in accordance with the design specifications.	
MAINTENANCE INDICATOR	CORRECTIVE ACTION
Clogged gutters, drains, downspouts, or inlets	Remove sediment, debris, and blockages from downspouts, gutters, pipes, and inlets to maintain at least 50% conveyance at all times. Clean at least twice a year depending on the presence of overhanging trees. Clear any build-up of soil, bark dust, and/or vegetative growth from around downspout extension and/or splash blocks. Verify there is sufficient slope so that water flows away from the foundation.
Damaged or missing pipes, gutters, and downspouts	Repair or replace broken gutters and downspouts as needed. Identify possible leaks and verify that roof flashing directs water into gutters. Look for low spots or sagging areas along the gutter line and repair as needed with new hangers.
Vegetation must cover at least 90% of the facility at maturity.	
MAINTENANCE INDICATOR	CORRECTIVE ACTION
Dead or stressed vegetation	Remove dead material; replant per original planting plan, or substitute from the plant list in Section 2.4.1 .
Dry grass or other plants	Irrigate and mulch as needed. Maintain grass height at 6"-9".
Weeds	Manually remove weeds
Growing medium must sustain healthy plant cover and infiltrate within 48 hours.	
MAINTENANCE INDICATOR	CORRECTIVE ACTION
Gullies, erosion, exposed soils, sediment accumulation	Fill in and lightly compact areas of erosion with City-approved soil mix (see Section 2.3.6) and replant according to planting plan or substitute from the plant list in Section 2.4.1 . Any erosion deeper than 2 inches must be addressed. Sediment more than 4 inches deep must be removed.
Scouring at the inlet(s)	Ensure splash blocks or inlet gravel/rock are adequate
Ponding	Till, amend, or rake soil as needed to ensure ponding water drains within 48 hours.

Annual Maintenance Schedule

Summer	Make structural repairs; clean gutters and downspouts; remove any build-up of weeds or organic debris.
Fall	Replant exposed soil and replace dead plants. Remove sediment and plant debris.
Winter	Clear gutters and downspouts.
Spring	Remove sediment and plant debris. Replant exposed soil and replace dead plants.
All seasons	Weed as necessary.

Maintenance Records: All facility operators are required to keep an inspection and maintenance log. Record date, description, and contractor (if applicable) for all repairs, landscape maintenance, and facility cleanout activities. Keep work orders and invoices on file and make available upon request of the City inspector.

Fertilizers/Pesticides/Herbicides: Their use is strongly discouraged because of the potential for damage to downstream systems. If pesticides or herbicides are required, use the services of a licensed applicator and products approved for aquatic use.

Access: Maintain ingress/egress per design standards.

Infiltration/Flow Control: All facilities must drain within 48 hours. Record time/date, weather, and conditions when ponding occurs.

Pollution Prevention: All sites must implement Best Management Practices to prevent contamination of stormwater. Call 503-823-7180 to report spills. Never wash spills into a stormwater facility. If contamination occurs, document the circumstances and the corrective action taken; include the time/date, weather, and site conditions.

Vectors (Mosquitoes and Rats): Stormwater facilities must not harbor mosquito larvae or rodents that pose a threat to public health or that undermine the facility structure. Record the time/date, weather, and site conditions when vector activity observed. Record when vector abatement started and ended.

Operations and Maintenance Log

Date	Work Performed By	Type of Work Performed					Notes	Initials
		Clean inlets and Outlets	Sediment and Trash Removal	Plant Replacement type, location	Structural Repairs – type, location	Other		

STANDARD O&M PLAN FOR THE SIMPLIFIED AND PRESUMPTIVE APPROACHES

3.1.1.6. Swales

Structural components must be operated and maintained in accordance with the design specifications.	
MAINTENANCE INDICATOR	CORRECTIVE ACTION
Clogged inlets or outlets	Remove sediment and debris from catch basins, trench drains, curb inlets, and pipes; maintain at least 50% conveyance at all times.
Broken inlets or outlets	Repair or replace broken downspouts, curb cuts, standpipes, and screens as needed.
Cracked or exposed drain pipes	Repair or seal cracks. Replace when repair is insufficient. Cover with 6 inches of growing medium to prevent freeze/thaw and UV damage.
Check dams missing or with gaps	Maintain or replace check dams as per design specifications.
Perforated liner	Repair or replace as necessary.
Vegetation must cover at least 90% of the facility at maturity.	
MAINTENANCE INDICATOR	CORRECTIVE ACTION
Dead or stressed vegetation	Replant per planting plan or substitute from the plant list in Section 2.4.1 .
Dry grass or other plants	Irrigate and mulch. Maintain grass height at 6"-9".
Tall grass and vegetation	Prune to allow sight lines and foot traffic. Prune to ensure inlets and outlets freely convey stormwater into and/or out of facility.
Weeds	Manually remove weeds.
Growing medium must sustain healthy plant cover and infiltrate within 48 hours.	
MAINTENANCE INDICATOR	CORRECTIVE ACTION
Erosion and sediment accumulation	Fill in and lightly compact areas of erosion with City-approved soil mix (see Section 2.3.6); replant according to planting plan or substitute from the plant list in Section 2.4.1 . Erosion deeper than 2 inches must be addressed. Sediment more than 4 inches deep must be removed.
Scouring at the inlet(s)	Ensure splash blocks or inlet gravel/rock are adequate.
Slope slippage	Stabilize 3:1 slopes/banks with plantings from the original planting plan or from the plant list in Section 2.4.1 .
Ponding	Rake, till, or amend soil surface with City-approved soil mix to restore infiltration rate.

Annual Maintenance Schedule

Summer	Make structural repairs; clean gutters and downspouts; remove any build-up of weeds or organic debris.
Fall	Replant exposed soil and replace dead plants. Remove sediment and plant debris.
Winter	Clear gutters and downspouts.
Spring	Remove sediment and plant debris. Replant exposed soil and replace dead plants.
All seasons	Weed as necessary.

Maintenance Records: All facility operators are required to keep an inspection and maintenance log. Record date, description, and contractor (if applicable) for all repairs, landscape maintenance, and facility cleanout activities. Keep work orders and invoices on file and make available upon request of the City inspector.

Fertilizers/Pesticides/Herbicides. Their use is strongly discouraged because of the potential for damage to downstream systems. If pesticides or herbicides are required, use the services of a licensed applicator and products approved for aquatic use.

Access: Maintain ingress/egress per design standards.

Infiltration/Flow Control: All facilities must drain within 48 hours. Record time/date, weather, and site conditions when ponding occurs.

Pollution Prevention: All sites must implement Best Management Practices to prevent contamination of stormwater. Call 503-823-7180 to report spills. Never wash spills into a stormwater facility. If contamination occurs, document the circumstances and the corrective action taken; include the time/date, weather, and site conditions.

Vectors (Mosquitoes and Rats): Stormwater facilities must not harbor mosquito larvae or rodents that pose a threat to public health or that undermine the facility structure. Record the time/date, weather, and site conditions when vector activity observed. Record when vector abatement started and ended.

Operations and Maintenance Log

Date	Work Performed By	Type of Work Performed					Notes	Initials
		Clean inlets and Outlets	Sediment and Trash Removal	Plant Replacement type, location	Structural Repairs – type, location	Other		

STANDARD O&M PLAN FOR THE PRESUMPTIVE APPROACH

3.1.1.7. Curb Extensions

Structural components must be operated and maintained in accordance with the design specifications.		
	MAINTENANCE INDICATOR	CORRECTIVE ACTION
	Clogged inlets or outlets	Remove sediment, debris, and blockages from catch basins, trench drains, curb inlets, and pipes to maintain at least 50% conveyance at all times. Sediment deeper than 4 inches must be removed.
	Broken inlets or outlets	Repair or replace broken downspouts, curb cuts, standpipes, and screens as needed.
	Cracked or exposed drain pipes	Repair or seal cracks. Replace when repair is insufficient. Cover with 6 inches of growing medium to prevent freeze/thaw and UV damage.
	Check dams missing or with gaps	Maintain or replace rock check dams as per design specifications.
Vegetation must cover at least 90% of the facility at maturity.		
	MAINTENANCE INDICATOR	CORRECTIVE ACTION
	Dead or stressed vegetation	Replant per planting plan, or substitute from the plant list in Section 2.4.1 .
	Dry grass or other plants	Irrigate and mulch; prune tall, dry grasses and remove clippings.
	Tall grass and vegetation	Trim to ensure inlets and outlets freely convey stormwater, and to allow sight lines and foot traffic. Maintain grass height at 6"-9".
	Weeds	Manually remove weeds
Growing medium must sustain healthy plant cover and infiltrate within 48 hours.		
	MAINTENANCE INDICATOR	CORRECTIVE ACTION
	Gullies or exposed soils	Fill in and lightly compact areas of erosion with City-approved soil mix (see Section 2.3.6) and replant according to planting plan or substitute from the plant list in Section 2.4.1 . Erosion deeper than 2 inches must be addressed.
	Scouring at the inlet(s)	Ensure splash blocks or inlet gravel/rock are adequate.
	Slope slippage	Stabilize 3:1 slopes/banks with plantings from the plant list in Section 2.4.1 .
	Ponding	Rake, till, or amend soil surface with City-approved soil mix to restore infiltration rate. Remove sediment at entrances.

Annual Maintenance Schedule

Summer	Make structural repairs; clean gutters and downspouts; remove any build-up of weeds or organic debris.
Fall	Replant exposed soil and replace dead plants. Remove sediment and plant debris.
Winter	Clear gutters and downspouts.
Spring	Remove sediment and plant debris. Replant exposed soil and replace dead plants.
All seasons	Weed as necessary.

Maintenance Records: Facility operators are required to keep an inspection and maintenance log. Record date, description, and contractor (if applicable) for all activities. File work orders and invoices and make available upon request of the City inspector.

Fertilizers/Pesticides/Herbicides: Their use is strongly discouraged because of the potential for damage to downstream systems. If pesticides or herbicides are required, use the services of a licensed applicator and products approved for aquatic use.

Access: Maintain ingress/egress per design standards.

Infiltration/Flow Control: All facilities must drain within 48 hours. Record time/date, weather, and site conditions when ponding occurs.

Pollution Prevention: All sites must implement Best Management Practices to prevent contamination of stormwater. Call 503-823-7180 to report spills. Never wash spills into a stormwater facility. If contamination occurs, document the circumstances and the corrective action taken; include the time/date, weather, and site conditions.

Vectors (Mosquitoes and Rats): Stormwater facilities must not harbor mosquito larvae or rodents that pose a threat to public health or that undermine the facility structure. Record the time/date, weather, and site conditions when vector activity observed. Record when vector abatement started and ended.

Operations and Maintenance Log

Date	Work Performed By	Type of Work Performed					Notes	Initials
		Clean inlets and Outlets	Sediment and Trash Removal	Plant Replacement type, location	Structural Repairs – type, location	Other		

STANDARD O&M PLAN FOR THE SIMPLIFIED AND PRESUMPTIVE APPROACHES

3.1.1.8. Planters

Structural components must be operated and maintained in accordance with the design specifications.	
MAINTENANCE INDICATOR	CORRECTIVE ACTION
Clogged inlets or outlets	Remove sediment and debris from catch basins, trench drains, curb inlets, and pipes; maintain at least 50% conveyance at all times.
Broken inlets or outlets	Repair/replace broken downspouts, curb cuts, standpipes, and screens.
Damaged liners and walls	Extend and secure liner to planter walls above the high water mark. The facility must be water tight to protect abutting foundations from moisture damage.
Cracked or exposed drain pipes	Repair or seal cracks. Replace when repair is insufficient. Cover with 6 inches of growing medium to prevent freeze/thaw and UV damage
Vegetation must cover at least 90% of the facility at maturity.	
MAINTENANCE INDICATOR	CORRECTIVE ACTION
Dead or stressed vegetation	Replant per original planting plan, or substitute from the plant list in Section 2.4.1 . Irrigate and mulch as needed; prune tall, dry grasses and remove clippings.
Tall grass and vegetation	Maintain grass height at 6"-9". Trim to allow sight lines and foot traffic, also to ensure inlets and outlets freely convey stormwater into and/or out of facility.
Weeds	Manually remove weeds.
Growing medium must sustain healthy plant cover and infiltrate within 48 hours.	
MAINTENANCE INDICATOR	CORRECTIVE ACTION
Gullies, erosion, exposed soils, sediment accumulations	Fill in and lightly compact areas of erosion with City-approved soil mix (see Section 2.3.6) and replant according to planting plan or substitute from the plant list in Section 2.4.1 . Sediment more than 4 inches deep must be removed.
Scouring at the inlet(s)	Ensure splash blocks or inlet gravel/rock are adequate.
Ponding	Rake, till, or amend soil surface with City-approved soil mix to restore infiltration rate. Remove and replace sediment at entrances.

Annual Maintenance Schedule

Summer	Make structural repairs; clean gutters and downspouts; remove any build-up of weeds or organic debris.
Fall	Replant exposed soil and replace dead plants. Remove sediment and plant debris.
Winter	Clear gutters and downspouts.
Spring	Remove sediment and plant debris. Replant exposed soil and replace dead plants.
All seasons	Weed as necessary.

Maintenance Records: All facility operators are required to keep an inspection and maintenance log. Record date, description, and contractor (if applicable) for all repairs, landscape maintenance, and facility cleanout activities. Keep work orders and invoices on file and make available upon request of the City inspector.

Fertilizers/Pesticides/Herbicides: Their use is strongly discouraged because of the potential for damage to downstream systems. If pesticides or herbicides are required, use the services of a licensed applicator and products approved for aquatic use.

Access: Maintain ingress/egress per design standards.

Infiltration/Flow Control: All facilities must drain within 48 hours. Record time/date, weather, and conditions when ponding occurs.

Pollution Prevention: All sites must implement Best Management Practices to prevent contamination of stormwater. Call 503-823-7180 to report spills. Never wash spills into a stormwater facility. If contamination occurs, document the circumstances and the corrective action taken; include the time/date, weather, and site conditions.

Vectors (Mosquitoes and Rats): Stormwater facilities must not harbor mosquito larvae or rodents that pose a threat to public health or that undermine facility structures. Record the time/date, weather, and site conditions when vector activity observed. Record when vector abatement started and ended.

Operations and Maintenance Log

Date	Work Performed By	Type of Work Performed					Notes	Initials
		Clean inlets and Outlets	Sediment and Trash Removal	Plant Replacement type, location	Structural Repairs – type, location	Other		

STANDARD O&M PLAN FOR THE SIMPLIFIED AND PRESUMPTIVE APPROACHES

3.1.1.9. Basins

Structural components must be operated and maintained in accordance with the design specifications.	
MAINTENANCE INDICATOR	CORRECTIVE ACTION
Clogged inlets or outlets	Remove sediment, debris, and blockages from catch basins, trench drains, curb inlets, and pipes to maintain at least 50% conveyance at all times
Broken inlets or outlets, including grates	Repair or replace broken downspouts, curb cuts, standpipes, and screens as needed.
Cracked or exposed drain pipes	Repair or seal cracks. Replace when repair is insufficient. Cover with 6 inches of growing medium to prevent freeze/thaw and UV damage.
Check dams missing/broken	Maintain or replace rock check dams as per design specifications.
Perforated liner	Replace or repair liner as needed.
Vegetation must cover at least 90% of the facility at maturity.	
MAINTENANCE INDICATOR	CORRECTIVE ACTION
Dead or stressed vegetation	Replant per original planting plan, or substitute from the plant list in Section 2.4.1 . Irrigate and mulch as needed; prune tall, dry grasses and remove clippings.
Tall grass and vegetation	Maintain grass height at 6"-9". Trim to allow sight lines and foot traffic, also to ensure inlets and outlets freely convey stormwater into and/or out of facility.
Weeds	Manually remove weeds.
Growing medium must sustain healthy plant cover and infiltrate within 48 hours.	
MAINTENANCE INDICATOR	CORRECTIVE ACTION
Gullies, erosion, exposed soil, sediment accumulation	Fill in and lightly compact areas of erosion with City-approved soil mix (see Section 2.3.6) and replant according to planting plan or substitute from the plant list in Section 2.4.1 . Erosion more than 2 inches deep must be addressed. Sediment more than 4 inches deep must be removed.
Scouring at the inlet(s)	Ensure splash blocks or inlet gravel/rock are adequate.
Slope slippage	Stabilize 3:1 slopes/banks with plantings from the original planting plan or from the plant list in Section 2.4.1 .
Ponding	Rake, till, or amend soil surface with City-approved soil mix to restore infiltration rate. Remove sediment at entrance.

Annual Maintenance Schedule

Summer	Make structural repairs; clean gutters and downspouts; remove any build-up of weeds or organic debris.
Fall	Replant exposed soil and replace dead plants. Remove sediment and plant debris.
Winter	Clear gutters and downspouts.
Spring	Remove sediment and plant debris. Replant exposed soil and replace dead plants.
All seasons	Weed as necessary.

Maintenance Records: All facility operators are required to keep an inspection and maintenance log. Record date, description, and contractor (if applicable) for all repairs, landscape maintenance, and facility cleanout activities. Keep work orders and invoices on file and make available upon request of the City inspector.

Fertilizers/Pesticides/Herbicides. Their use is strongly discouraged because of the potential for damage to downstream systems. If pesticides or herbicides are required, use the services of a licensed applicator and products approved for aquatic use.

Access: Maintain ingress/egress per design standards.

Infiltration/Flow Control: All facilities must drain within 48 hours. Record time/date, weather, and conditions when ponding occurs.

Pollution Prevention: All sites must implement Best Management Practices to prevent contamination of stormwater. Call 503-823-7180 to report spills. Never wash spills into a stormwater facility. If contamination occurs, document the circumstances and the corrective action taken; include the time/date, weather, and site conditions.

Vectors (Mosquitoes and Rats): Facilities must not harbor mosquito larvae or rodents. Record the time/date, weather, and site conditions when vector activity is observed. Record when vector abatement started and ended.

Operations and Maintenance Log

Date	Work Performed By	Type of Work Performed					Notes	Initials
		Clean inlets and Outlets	Sediment and Trash Removal	Plant Replacement type, location	Structural Repairs – type, location	Other		

STANDARD O&M PLAN FOR THE SIMPLIFIED APPROACH

3.1.1.10. Filter Strips (Vegetated Filters)

Structural components must be operated and maintained in accordance with the design specifications.	
MAINTENANCE INDICATOR	CORRECTIVE ACTION
Ineffective flow spreader	Repair structure to evenly disperse flow.
Vegetation must cover at least 90% of the facility at maturity.	
MAINTENANCE INDICATOR	CORRECTIVE ACTION
Dead or stressed vegetation	Replant per planting plan, or substitute from Section 2.4.1 plant list.
Dry grass or other plants	Irrigate and mulch as needed; trim tall grasses and remove clippings. Maintain grass height at 6"-9".
Tall grass and vegetation	Prune to allow sight lines.
Weeds	Manually remove weeds.
Growing medium must sustain healthy plant cover.	
MAINTENANCE INDICATOR	CORRECTIVE ACTION
Gullies, erosion, or exposed soils	Fill in and lightly compact areas of erosion with City-approved soil mix (see Section 2.3.6) and replant according to planting plan or substitute from Section 2.4.1 Plant list. Erosion deeper than 2 inches must be addressed.
Slope slippage	Stabilize slopes with plantings from the plant list in Section 2.4.1 .

Annual Maintenance Schedule

Summer	Make structural repairs; clean gutters and downspouts; remove any build-up of weeds or organic debris.
Fall	Replant exposed soil and replace dead plants. Remove sediment and plant debris.
Winter	Clear gutters and downspouts.
Spring	Remove sediment and plant debris. Replant exposed soil and replace dead plants.
All seasons	Weed as necessary.

Maintenance Records: All facility operators are required to keep an inspection and maintenance log. Record date, description, and contractor (if applicable) for all repairs, landscape maintenance, and facility cleanout activities. Keep work orders and invoices on file and make available upon request of the City inspector.

Fertilizers/Pesticides/Herbicides: Their use is strongly discouraged because of the potential for damage to downstream systems. If pesticides or herbicides are required, use the services of a licensed applicator and products approved for aquatic use.

Access: Maintain ingress/egress per design standards.

Pollution Prevention: All sites must implement Best Management Practices to prevent contamination of stormwater. Call 503-823-7180 to report spills. Never wash spills into a stormwater facility. If contamination occurs, document the circumstances and the corrective action taken; include the time/date, weather, and site conditions.

Vectors (Mosquitoes and Rats): Stormwater facilities must not harbor mosquito larvae or rodents that pose a threat to public health or that undermine the facility structure. Record the time/date, weather, and site conditions when vector activity observed. Record when vector abatement started and ended.

Operations and Maintenance Log

Date	Work Performed By	Type of Work Performed				Notes	Initials
		Sediment and Trash Removal	Plant Replacement type, location	Structural Repairs – type, location	Other		

STANDARD O&M PLAN FOR THE SIMPLIFIED APPROACH

3.1.1.11. Drywells and Soakage Trenches

Structural components must be operated and maintained in accordance with the design specifications.	
MAINTENANCE INDICATOR	CORRECTIVE ACTION
Clogged inlets, manholes, catch basins, or silt traps	Clean gutters, rain drains, catch basins, or silt traps at least twice a year. Remove sediment, debris, and blockages from catch basins, trench drains, curb inlets, and pipes to maintain at least 50% conveyance at all times.
Cracked drain pipes, catch basins or manholes	Repair or seal cracks. Replace when repair is insufficient.
Vegetation encroachment	Prevent large root systems from trees and bushes from damaging subsurface structural components.
Ponding water	Remove sediment and debris from all accessible components. Repeated ponding in the system may indicate end of facility life. Consult with City prior to decommissioning or replacement activities.

Annual Maintenance Schedule

Summer	Make structural repairs. Clear drains, inlets and catch basins.
Fall	Clean gutters and rain drains; remove sediment and plant debris.
Winter	Monitor infiltration rates.
Spring	Clean gutters and rain drains

Maintenance Records: All facility operators are required to keep an inspection and maintenance log. Record date, description, and contractor (if applicable) for all repairs, landscape maintenance, and facility cleanout activities. Keep work orders and invoices on file and make available upon request of the City inspector.

Access: Maintain ingress/egress per design standards.

Infiltration/Flow Control: All facilities must drain within 48 hours. Record time/date, weather, and site conditions when ponding occurs.

Pollution Prevention: All sites must implement Best Management Practices to prevent contamination of stormwater. Call 503-823-7180 to report spills. Never wash spills into a stormwater facility. If contamination occurs, document the circumstances and the corrective action taken; include the time/date, weather, and site conditions.

Vectors (Mosquitoes and Rats): Stormwater facilities must not harbor mosquito larvae or rodents that pose a threat to public health or that undermine the facility structure. Record the time/date, weather, and site conditions when vector activity observed. Record when vector abatement started and ended.

Operations and Maintenance Log

Date	Work Performed By	Type of Work	Notes	Initials

3.1.2 Performance Approach Maintenance Requirements

When the Performance Approach is used to design stormwater management facilities on private property, the required O&M submittal to BES is:

- A completed O&M Form that has been recorded with the appropriate county, including a site plan attached to the form.
- A site-specific O&M Plan. The plan defines the O&M procedures, schedule, and persons responsible for implementing and documenting O&M activities. It must fully address the requirements of the site and the proposed stormwater infrastructure, including all stormwater management facilities and conveyance features.

The site-specific O&M Plan is a component of the Stormwater Management Report and must be prepared for review by BES using the outline in Figure 3-1. The plan must include a description of each type of facility servicing the site, the impervious area draining to the facilities, all stormwater conveyance pipes, and the facilities' discharge locations. The plan must also detail the visual indicators and activities necessary to maintain each facility type.

Figure 3-1. O&M Plan Outline

I. Description
<ul style="list-style-type: none"> • Summary of the onsite stormwater system. • Table identifying each stormwater facility and conveyance feature, including stormwater source, square footage managed, and discharge location. • Location of stormwater facilities and conveyance features in relation to permanent structures or landmarks.
II. Inspection and Visual Indicators of Diminished Performance
<ul style="list-style-type: none"> • When and how often the stormwater facilities or conveyance features will be inspected. • Definition of what storm sizes require additional inspections. • Description of visual indicators that would trigger maintenance activities.
III. Maintenance Activities
<ul style="list-style-type: none"> • Specific procedures for each facility type. • Likely deficiencies and corrective actions. • Course of action for unexpected deficiencies. • Site BMPs for effective stormwater management.
IV. Financial Responsibility
<ul style="list-style-type: none"> • Designation and contact information of entity responsible for site operation and maintenance.
V. Inspection and Maintenance Logs
<ul style="list-style-type: none"> • Instructions for maintaining required logs.

I. Description

The summary must adequately describe the overall stormwater management objectives and the responsibilities of the property owner. It must include the Stormwater Hierarchy, specifically whether the managed stormwater is infiltrated onsite or discharged offsite. It must also describe the stormwater system in the area impacted by the development, including details about the function of each stormwater management facility and all natural and constructed conveyance features such as drainageways, culverts, and outfalls.

A table must be included listing each stormwater facility with the facility type, size, location, stormwater source (rooftop, parking lot, or road runoff), source area (square footage), discharge location, and access point.

The site plan must identify the location of each stormwater facility and conveyance feature. Locations must be clarified by measurements from permanent structures or GPS coordinates.

II. Inspection and Visual Indicators of Diminished Performance

All components of the O&M Plan should be inspected at least:

- Quarterly for the first two years.
- Twice a year thereafter.
- Within 48 hours of major rainfall events (defined as more than one inch of rain over a 24-hour period).

For at least the first two years, the design drawings and the O&M Plan should be present during inspections so it is clear how the site should function. The O&M Plan will help the inspector recognize signs of diminished performance. Visual indicators of maintenance needs should be noted for each facility.

III. Maintenance Activities

Each type of stormwater facility and conveyance feature must have its own section that describes the duties required to maintain that facility or feature and keep it in working order. It is expected that variations in facility configurations as well as variations in sources (rooftop, parking lot, or roadway runoff) will result in different procedures. Maintenance indicators and their corrective actions must also be described.

Maintenance activities must also include best management practices specific to site activities and functions to improve system performance. Examples include lot sweeping or catch basin cleaning.

The following sections present different types of maintenance activities that may be necessary in the site-specific O&M Plan. If usual maintenance practices do not resolve issues, professional services may be required.

Site Best Management Practices

Onsite maintenance practices can reduce maintenance needs for stormwater facilities. Good housekeeping procedures such as trash or source control practices can reduce spills and prevent pollutants from entering facilities.

Remove trash, debris and sediment from parking lots and catch basins. Identify sources of visible pollutants or spills and clean up sources to protect the stormwater system. Sweep or vacuum parking lots or other ground-level surfaces. Report all spills that threaten or enter the public sanitary or storm system (503-823-7180).

Sediment and Oil Removal and Disposal

Stormwater facilities are designed to remove pollutants by capturing sediment, dirt, leaves and litter. Removing sediment and oil helps maintain facility infiltration rates, provide good water quality treatment, and prevent clogging and flooding.

In vegetated facilities, sediment should be removed when it reaches a depth of four inches, when the quantity reaches 30 percent of total capacity (as designed or measured) or when accumulated sediment is impeding facility function. Examples include when sediment is damaging vegetation, preventing the facility from draining, blocking inlets or causing bypass.

Remove sediment by hand unless professionals are needed because of confined space entry requirements or the need for a vacuum truck. Dispose of sediment per solid waste disposal requirements. Removing sediment during dry periods is easier because the material weighs substantially less.

Vegetation Management

Healthy plants play important roles: the root systems absorb stormwater, help maintain infiltration rates, prevent erosion, and capture pollutants. Vegetated facilities must be checked for maintenance needs quarterly for the first two years and then twice a year after that.

If a vegetated stormwater facility has bare soil, or if vegetation is stressed, unhealthy, or dead, replant per the approved planting plan and/or address cause of stress. Remove nuisance and invasive plants.

Healthy vegetation must cover at least 90% of stormwater facility surface area. Grass must be mowed to keep it four to nine inches tall. Prune or trim vegetation or roots to

ensure free conveyance of stormwater or improve sight lines. Remove leaves or other debris. Use weed-free mulch to inhibit weeds. Irrigate as needed.

The use of fertilizers and pesticides (including herbicides) is strongly discouraged in stormwater management facilities because of the potential for negative impacts to downstream systems. Integrated Pest Management strategies are encouraged to reduce or eliminate the need for pesticides. If pesticides are required, use the services of a licensed applicator and products approved for aquatic use.

Erosion, Bank Failure, and Channel Formation

Erosion in the flow path, inside or outside a facility, can clog inlets and outlets and reduce both conveyance efficiency and infiltration rates. Forms of erosion include channels, undercutting, scouring, and slumping. Any area with erosion more than two inches deep must be addressed. Install long-term erosion control practices and fill the eroded areas.

Structural Repairs

Structural components control the conveyance of stormwater. Examples include inlets, outlets, trash racks, concrete curbs, retaining walls, manholes and check dams. Repair or replace items when damaged, loose, broken, cracked, or askew. Monitor minor damage such as dents, rust, or minor cracks in concrete for indications of when repair or replacement is required.

Ponding water

Most stormwater facilities are designed to drain in a certain amount of time. The O&M Plan should specify the anticipated ponding depth, infiltration rate, and drawdown time. When the facility does not drain as anticipated, inspect the facility to determine the cause. Clear clogged inlets or outlets, remove sediment that may be preventing infiltration, or add vegetation.

Pests

Stormwater facilities are designed to drain quickly enough to avoid providing breeding areas for pests. If mosquitos are found, the stormwater facility may be ponding water longer than the approved design but also search for nearby sources of standing water. If rodents are found, remove plant debris, fruit or nuts that are providing shelter and food and contact the appropriate county vector control office for trapping and removal.

Safety

Stormwater facilities must be maintained to protect workers, visitors, and the general public. Vegetation should be pruned for adequate visual clearance. Avoid maintenance

in wet weather to reduce potential injuries from slipping and always use appropriate safety gear. Only personnel approved for confined space entry should enter underground stormwater facilities.

Manufactured Stormwater Treatment Technology Maintenance

Operations and maintenance (O&M) of manufactured stormwater treatment technologies (MSTT) are specific to the device and are critical to their performance removing pollutants from runoff. Design and installation of individual devices is done in partnership with the manufacturer, who provides a letter confirming that the device has been sited, sized, and designed appropriately. The project designer is responsible for confirming that any conditions of use from the City of Portland are met.

Each MSTT has a recommended operations and maintenance guide or plan provided by the manufacturer that includes minimum inspection frequencies, maintenance triggers, and typical media replacement frequencies. The specific MSTT operations and maintenance plan must be attached to the Operations and Maintenance Plan.

Changes to pollutant loading or site conditions, spills, localized erosion, or large storm events may require more frequent maintenance visits in order to maintain performance. Minimum maintenance practices or frequencies may require modification in order to maintain MSTT functionality.

Even if the manufacturer includes a maintenance plan or warranty with the device at the time of purchase, ultimate responsibility for operations and maintenance is with the property owner. It is the property owner's responsibility to document completion of maintenance per any maintenance agreement or while under warranty.

IV. Financial Responsibility

The party responsible for current and ongoing O&M activities must be identified. The name of the responsible party must be updated as needed whenever the facility is inspected under BES's [Maintenance Inspection Program \(MIP\)](#).

A facility maintenance fund is recommended for both operating procedures (regular maintenance) and capital procedures (major overhauls or replacement). Costs depend on the characteristics of the facility, the site, and the drainage area. The general recommendation is that annual maintenance costs should be 5 to 10 percent of the facility's total capital cost. Routine scheduled maintenance can help keep costs down by addressing problems before they require major attention.

V. Inspection and Maintenance Logs

Portland City Code requires property owners to keep an Inspection and Maintenance Log. In general, the log must note all inspection dates, the facility components that were inspected, and any maintenance or repairs performed. The property owner is responsible for ensuring that the maintenance is completed and records are kept, even if someone other than the property owner is performing the maintenance, such as a facility manger or maintenance company. City may accept other documentation including work orders, invoices, or receipts in lieu of an inspection and maintenance log. The intent is to demonstrate compliance with O&M requirements.

If there is a maintenance contract with the manufacturer of a manufactured stormwater treatment technology, the manufacturer's maintenance logs must generally include the same type of information and level of detail as required for stormwater management facilities.

Owners who are not sure their maintenance documentation is sufficient can call BES at 503-823-7761 for proposed O&Ms (those still under development review) or 503-823-5600 for existing O&Ms (already constructed facilities) to get review and approval of their forms.

Operations and Maintenance Log

Date	Work Performed By	Type of Work Performed				Notes	Initials
		Sediment and Trash Removal	Plant Replacement type, location	Structural Repairs – type, location	Other		

3.1.3 Stormwater Conveyance Features

Stormwater conveyance features include drainageways, culverts, and outfalls that are used to transport drainage, stormwater and surface waters. Conveyance features serve important hydrologic, hydraulic, and water quality functions for Portland's waterways and stormwater systems.

Drainageways and any related encroachments must be maintained to preserve key watershed processes. In addition to ecological benefits, they provide beneficial functions such as flood attenuation and water quality treatment. Culverts and outfalls must be maintained to minimize negative effects on watershed processes and ecological functions while adequately conveying flows downstream.

The private property owner is responsible for preserving and maintaining conveyance features as protected or constructed to approved plans. Any future development proposals must protect stormwater conveyance features to ensure continuation of flow conveyance and other benefits. Stormwater Conveyance features require an O&M submittal to BES that includes:

- A Standard O&M Plan for conveyance features; and
- A completed O&M Form that has been recorded with the appropriate county. A Site Plan (either sketched or attached) must be included.

O&M submittal requirements are listed in Section 3.1.4. Specific requirements for conveyance features are outlined below.

Drainageways, Drainage Reserves, and related Encroachments

An Operations and Maintenance (O&M) plan is required for drainageways on properties undergoing development proposal review, regardless of whether the drainageway is being impacted by the development proposal. O&M plans are required when drainage reserves are being applied to a drainageway during development proposal review or for a permitted improvement or encroachment to a drainage reserve. Operations and Maintenance Plans must be recorded with an O&M Form in the county of the subject property.

Culverts and Outfalls

An O&M Plan is required for culverts and outfalls on properties undergoing development proposal review, regardless of whether or not the culvert or outfall is directly associated with a stormwater management facility.

STANDARD OPERATIONS AND MAINTENANCE PLAN

3.1.3.1. Drainageway and Drainage Reserves

The limits of the drainage reserve must remain in natural topographic condition.	
MAINTENANCE INDICATOR	CORRECTIVE ACTION
Existing encroachments or modifications to drainage reserve.	Document existing encroachments (such as fences, rock walls or pipes) on the operations and maintenance site plan.
New encroachments or modifications to the drainageways that have not undergone review or approval.	Remove encroachments and return drainageway to natural topographic condition.
No vegetation in the drainageway or drainage reserve limits can be on Portland's lists of nuisance or prohibited plants.	
MAINTENANCE INDICATOR	CORRECTIVE ACTION
Nuisance or prohibited plants are discovered within the drainage reserve.	<ul style="list-style-type: none"> • Manually remove weeds. Do not use fertilizers, herbicides or pesticides. • Nuisance and prohibited vegetation from the Portland Plant List (such as Himalayan blackberries and English Ivy) must be removed when discovered. • Invasive vegetation contributing to more than 25% of vegetation of all species must be removed and replaced. • Mulch as needed outside of the drainage channel. Stabilize soils with plants from the Portland Plant List.

STANDARD OPERATIONS AND MAINTENANCE PLAN

3.1.3.2. Drainage Reserve or Channel Encroachment

Natural and structural components, including inlets and outlets/overflows, must freely convey stormwater.		
	MAINTENANCE INDICATOR	CORRECTIVE ACTION
	Clogged inlets or outlets	<ul style="list-style-type: none"> Remove sediment, vegetation, and debris from catch basins, trench drains, curb inlets, and pipes; maintain at least 50% conveyance capacity at all times. Identify obstructions and clear them immediately.
	Clogged conveyance capacity	<ul style="list-style-type: none"> Hand-remove sediment, minimizing damage to native vegetation and using proper erosion control measures. Trim vegetation, large shrubs, or trees that can flood structures or increase bank erosion.
	Erosion	<ul style="list-style-type: none"> Control erosion when native soil is exposed or erosion channels are forming. Maintain rock splash pads or energy dissipaters to prevent erosion. Stabilize soils with plants from the Portland Plant List. Use biodegradable erosion control materials. Remove non-biodegradable erosion control materials within 3 years or when plantings are established. Thoroughly irrigate planted areas until vegetation is well established.
	Bank/Side Slope maintenance	<ul style="list-style-type: none"> Stabilize and plant slopes using appropriate erosion control measures when native soil is exposed or erosion channels form.
	Obstructed or non-functioning check-dams	<ul style="list-style-type: none"> Clear and repair check dams to control and distribute flow. Identify and repair causes for channelization causing erosion.
Within 2 years at least 90% native vegetation coverage within the drainage reserve area must be well-maintained and healthy; vegetation must be healthy and dense enough to provide filtering while protecting underlying soils from erosion.		
	MAINTENANCE INDICATOR	CORRECTIVE ACTION
	Dead or dying vegetation	<ul style="list-style-type: none"> Remove dead vegetation and woody material from drainageways when flow is impeded. Replace vegetation to maintain 90% cover density within one year and control erosion where soils are exposed.
	Nuisance or prohibited plants are discovered within the drainage reserve	<ul style="list-style-type: none"> Manually remove weeds. Do not use fertilizers, herbicides or pesticides. Remove nuisance and prohibited vegetation from the Portland Plant List (such as Himalayan blackberries and English Ivy) on discovery. Remove and replace invasive vegetation when it comprises more than 25% of the total vegetative cover. Mulch as needed outside of the drainage channel.

Maintenance Records: Training and/or written guidance for protecting and maintaining drainage reserves (including this O&M Plan) must be provided to all property owners and tenants. The property owner must keep a log, recording all inspection dates, observations, and maintenance activities. This log must be available to City inspectors on request.

Pesticides and Herbicides: The use of pesticides and herbicides is strongly discouraged due to the potential negative impacts to downstream systems. If pesticides and herbicides are required, use the service of a licensed applicator and a product approved for aquatic use.

Inspections: Drainage reserves which have been modified through a City permit process must be inspected and maintained by the property owner in order to ensure proper function. All facility components, vegetation, and source controls must be inspected for proper operations and structural stability, at a minimum, quarterly for the first 2 years from the date of installation, 2 times per year thereafter, and within 48 hours after each major storm event (defined as 1" in 24 hours).

Access: Access to the drainageway must be safe and efficient. Egress and ingress routes must be maintained to design standards. Maintain roadways to accommodate the size and weight of vehicles, if applicable. Obstacles preventing maintenance personnel and/or equipment access to the drainageway must be removed. Gravel or ground cover must be added if erosion occurs, e.g., due to vehicular or pedestrian traffic.

Pollution Prevention: Spill Prevention measures must be exercised when handling substances that contaminate stormwater. Releases of pollutants must be corrected as soon as identified.

STANDARD OPERATIONS AND MAINTENANCE PLAN

3.1.3.3. Culverts

Structural components must be operated and maintained in accordance with the design specifications. Culvert inlets and outlets must maintain an unimpeded and controlled flow of water.		
	MAINTENANCE INDICATOR	CORRECTIVE ACTION
	Clogged conveyance capacity	<ul style="list-style-type: none"> • Clear pipes when conveyance capacity is compromised. • Remove accumulated debris and sediment when it blocks 1-foot or 50% of conveyance capacity, whichever is smaller.
	Sediment accumulation	<ul style="list-style-type: none"> • Remove sediment accumulations in pipes using proper erosion control measures.
	Erosion or exposed soils	<ul style="list-style-type: none"> • Control erosion when native soil is exposed or erosion channels are forming. • Use biodegradable erosion control materials. • Remove non-biodegradable erosion control devices within 3 years or when the erosion control plantings are established. • Stabilize soils with plants from the Portland Plants List referenced in Appendix B.
	Cracked or broken pipe/structure	<ul style="list-style-type: none"> • Repair or replace broken or cracked components.
	Scouring at the entrance or exit	<ul style="list-style-type: none"> • Ensure adequate scour protection is provided at the inlet and outlet.
	Bank/side slope stabilization	<ul style="list-style-type: none"> • Stabilize sloped banks with plantings from the Portland Plant List.

Maintenance records: Training and/or written guidance for protecting and maintaining culverts (including this O&M Plan) must be provided to all property owners and tenants. The property owner must keep a log, recording all inspection dates, observations, and maintenance activities. This log must be available to City inspector upon request.

Inspections: Culverts must be inspected and maintained by the property owner to ensure proper function. Inspect facility components for proper operation and structural stability, at a minimum, quarterly for the first 2 years from the date of installation, 2 times per year thereafter, and within 48 hours after each major storm event (defined as 1" in 24 hours).

Access: Access to the culvert must be safe and efficient. Egress and ingress routes must be maintained to design standards. Roadways must be maintained to accommodate size and weight of vehicles, if applicable.

Pollution Prevention: Implement spill prevention measures when handling substances that could contaminate stormwater. Releases of pollutants must be corrected as soon as identified.

STANDARD OPERATIONS AND MAINTENANCE PLAN

3.1.3.4. Outfalls

Structural components must be operated and maintained in accordance with the design specifications. Outfall inlet & outlet must maintain an unimpeded and controlled flow of water.	
MAINTENANCE INDICATOR	CORRECTIVE ACTION
Clogged inlets or outlets	<ul style="list-style-type: none"> • Clear inlets and outlets including piped outfalls they are plugged. • Address sources of sediment and debris.
Clogged conveyance capacity	<ul style="list-style-type: none"> • Clear overland flow paths and drains when conveyance capacity is diminished by 50%. • Identify causes for altered flow; clear obstructions on discovery.
Sediment accumulation	<ul style="list-style-type: none"> • Remove sediment from pipes using proper erosion control measures.
Erosion or exposed soils	<ul style="list-style-type: none"> • Identify and control sources of erosion when native soil is exposed or erosion channels are forming. • Maintain rock splash pads or energy dissipation structures. • Use biodegradable materials. • Remove non-biodegradable erosion control devices within 3 years or when the erosion control plantings are established. • Stabilize soils with plants from the Portland Plant List.
Cracked or broken pipe/structure	Repair or replace broken or cracked components when necessary.
Check dams missing, scattered or with gaps	Maintain check dams as per standard details.
Scouring at the entrance or exit	Ensure energy dissipation structures such as splash pads, rock rip-rap, gravel, and log check dams are properly installed and replenish materials as necessary.
Bank/side slope stabilization	Stabilize sloped banks with plantings from the Portland Plant List.

Maintenance Records: Training and/or written guidance for protecting and maintaining outfalls (including this O&M Plan) must be provided to all property owners and tenants. The property owner must keep a log, recording all inspection dates, observations, and maintenance activities. This log must be available to City inspector upon request.

Inspections: Outfall must be inspected and maintained by the property owner in order to ensure proper function. All facility components must be inspected for proper operations and structural stability, at a minimum, quarterly for the first 2 years from the date of installation, 2 times per year thereafter, and within 48 hours after each major storm event (defined as 1" in 24 hours).

Access: Access to the outfall must be safe and efficient. Egress and ingress routes must be maintained to design standards. Roadways must be maintained to accommodate size and weight of vehicles, if applicable.

Pollution Prevention: Spill Prevention measures must be exercised when handling substances that contaminate stormwater. Releases of pollutants must be corrected as soon as identified.

3.1.4 Private O&M Submittal Requirements

For private stormwater facilities and conveyance features which are implemented or protected under the requirements of the *Stormwater Management Manual*, Operations and maintenance (O&M) is the responsibility of the property owner or designated responsible party. O&M responsibilities and requirements are identified and enforced through an Operations and Maintenance Form and an Operations and Maintenance Plan submitted for BES review and approval prior to permit issuance.

An Operations and Maintenance Plan must meet the requirements of this chapter. For stormwater facilities designed under the Simplified and Presumptive approach, a Standard O&M Plan must be used. For stormwater facilities designed under the Performance Approach, a site-specific plan must be developed. For conveyance features, a Standard O&M Plan may be used to meet the requirements of this chapter or a site-specific plan must be used.

The Bureau of Environmental Services (BES) must review and approve the submittals as part of the development review process (e.g. building or site development permits). Maintaining the stormwater management facilities and conveyance features shown on the site plan is a required condition of the City's approval of the building permit for the identified property.

The applicant must sign the Form and the signature must be notarized. The O&M Form and Plan must be recorded and filed with the county Department of Assessment and Taxation in the county where the property site is located. When completed accurately, the O&M Form meets the recording requirements in Multnomah, Clackamas, and Washington counties.

Failure to properly operate or maintain a stormwater management facility according to the O&M Plan may result in a civil penalty, as specified in Portland City Code [17.38.045: Enforcement](#). This requirement is binding on all current and future owners of the property. Failure to comply with the O&M Plan can trigger an enforcement action, including penalties.

How to complete the Operations and Maintenance Form

The O&M Form must be completed in full as listed below.

Site Legal Description

The Site Legal Description must include all of the tax lots (parcels) with stormwater runoff managed by the onsite stormwater management system. The information must be accurate and correctly filled out on the Form prior to submittal to the County for recording.

To find a property's legal description, visit <https://www.portlandmaps.com/> and browse to the property using the exact address. To locate the Site Legal Description at PortlandMaps.com, select the "Assessor" link on the top menu and locate the boxes labeled "Tax Roll" and "Instrument Number" on the page. If the Tax Roll description has "TL" in it, include the Instrument Number where indicated on Form 2. This information is intended as guidance; it may not be adequate to be accepted for filing by Multnomah County.

Site Plan

The O&M Form includes a small space for a sketched site plan. If the space is not sufficient to include all of the below information, attach a separate site plan. The site plan must include:

- Property boundaries and a north arrow.
- The locations of all of the stormwater facilities and conveyance features in relation to labeled streets, buildings, or other permanent features.
- The locations of utilities including existing-to-remain and proposed water, sanitary, and storm sewers.
- Facility dimensions and setback distances from property lines and structures;
- All stormwater piping associated with the facility including pipe sizes, materials, slopes, and invert elevations.
- Flow arrows illustrating the direction of flow and the order in which stormwater passes through the system if there is a sequence of facilities ("treatment train").
- A cross section for each facility with general dimensions and subsurface elements such as liners, layers of soil and aggregate, and pipes.
- Identify any offsite discharge locations. Include a label indicating the location, ownership, and type of the system to which the discharge drains.

- Additional information may be required on the drawings during permit review, depending on individual site conditions.

If the stormwater system design needs to be modified during the course of a project, and prior to Substantial Completion, please contact BES at 503-823-7761 for guidance on how best to modify and update the O&M Form and/or Plan to reflect the system as built. If the O&M Form and/or Plan requires revision, either because the O&M Form and/or Plan on file with the City is inaccurate or because the owner(s) request and receive City approval to revise it, the owner must record a new O&M Form or Plan with the County. Call the Maintenance Inspection Program at (503) 823-5600 for guidance.

Completed and Recorded O&M Forms and Plans must be filed with BES at the following address:

City of Portland, BES
1900 SW Fourth Ave., Suite 5000
Portland, OR 97201

County Recorder's Office Information

Multnomah County Recorder
501 SE Hawthorne St.
Suite 175
Portland, OR 97214
<https://multco.us/recording/recording-documents>
Phone: 503-988-3326

Clackamas County Recording Division
1710 Red Soils Ct., #110
Oregon City, OR 97045
<http://www.clackamas.us/recording/>
Phone: 503-655-8551

Washington County Recording Division
155 N. First Ave.
Suite 130, MS 9
Hillsboro, OR 97124
<http://www.co.washington.or.us/AssessmentTaxation/Recording/>
Phone: 503-846-8752



CITY OF PORTLAND
Stormwater
Management
Manual

OPERATIONS & MAINTENANCE FORM

PRIVATE STORMWATER MANAGEMENT FACILITIES

This O&M Form supercedes document number _____

(for official county use only)

PROJECT NAME _____

PERMIT INFORMATION

Permit # _____

Permit Submittal Date _____

SITE INFORMATION (include all parcels)

R# (6 Digits) _____

Site Address _____

City / State / Zip _____

Preparation Date: _____

OWNER INFORMATION (ALL LEGAL OWNERS)

Name (1) _____

Name (2) _____

Address (Mailing) _____

City / State / Zip _____

O&M PREPARER INFORMATION

Name _____

Address (Mailing) _____

City / State / Zip _____

Phone (area code required) _____

Email _____

Site Legal Description:

Responsible Party for Maintenance (check one)

Homeowners Association Property Owner

Property Management Company Tenant

Other (describe) _____
(not Contractor or Consultant)

Contact Information for Responsible Party

Contact Name _____

Contact Organization _____

Phone (area code required) _____

Email: _____

Maintenance Practices and Schedule

These operation and maintenance practices are required in accordance with Portland City Code, Chapter 17.38.

The requirements are based on the current version of the *City of Portland Stormwater Management Manual* on the date of permit submittal.

For the **Simplified Approach and Presumptive Approach**, please attach the Standard O&M Plan for each facility type from the *Stormwater Management Manual*, Chapter 3.1.1

For the **Performance Approach**, please attach the approved, site specific O&M Plan per the *Stormwater Management Manual*, Chapter 3.1.2

OPERATIONS & MAINTENANCE FORM

PRIVATE STORMWATER MANAGEMENT FACILITIES

SITE PLAN

Provide a site plan sketch in the area provided below, or attach a scaled site plan to this submittal that includes all of the information required as shown in Chapter 3.1.4, in Operations & Maintenance, Submittal Requirements, Site Plan.

STEP 1 – COMPLETE THE FOLLOWING TABLE

Stormwater Facility Type (Chapter 2)	Stormwater Facility Size (sf)	Drainage is from Roof or Lot?	Impervious Area Treated (sf)	Discharge Point
Totals				

Maintaining the stormwater management facility or facilities listed above shown on the following (or attached) site plan is a required condition of building permit approval for the identified property. Property owners are required to operate and maintain facilities in accordance with the O&M plan on file with the City of Portland. This requirement is binding on all current and future owners of the property. Failure to comply with the O&M plan can trigger an enforcement action, including penalties. The O&M plan may be modified by written consent of current owners and written approval of the Bureau of Environmental Services.

STEP 2 – REQUIRED SITE PLAN

(insert or draw here, or attach separate sheet)

I Have Attached a Site Plan

OPERATIONS & MAINTENANCE FORM

PRIVATE STORMWATER MANAGEMENT FACILITIES

SIGNATURE AND ACKNOWLEDGEMENT

By signing below, the owner accepts and agrees to the terms and conditions contained in this O&M Form and in any document executed by filer and recorded with it. The owner further acknowledges that this documentation has been prepared on their behalf and that they are responsible for the quality and completeness of the O&M Plan. Any failure to comply with the terms of these plans may result in enforcement actions by BES requiring the property owner to restore the stormwater facilities to a functional state as approved under original requirements.

The owner also accepts that the City requires property owners to submit and record, with the County, complete and accurate O&Ms enforceable under City Code 17.38 and that substantial changes to the O&M require City approval prior to County recording. A revised O&M must state that it supersedes a previous O&M (with cited county document number; See Page 1).

THIS PAGE MUST BE SIGNED IN THE PRESENCE OF A NOTARY.

Property Owner or Authorized Representative (1) Signature

Property Owner or Authorized Representative (2) Signature

NOTARY SIGNATURE AND STAMP

INDIVIDUAL Acknowledgement

This acknowledgement is intended for property owned by individuals or trusts.

STATE of OREGON county of: _____

This instrument was acknowledged
before me on: *(date)* _____

By: *(owner 1)* _____

By: *(owner 2)* _____

Notary Signature _____

My Commission Expires _____

Notary Seal:

OR CORPORATE Acknowledgement

This acknowledgement is intended for corporation, government agencies, school districts, or other formal entities

STATE of OREGON county of: _____

This instrument was acknowledged
before me on: *(date)* _____

By: *(representative)* _____

As: *(Title)* _____

Of: *(Corporation)* _____

Notary Signature _____

My Commission Expires _____

Notary Seal:

3.2 Operations and Maintenance Requirements for Future Public Facilities

Stormwater management facilities constructed via a Public Works Permit and intended to receive runoff from the public right-of-way are expected to become public (City-maintained) infrastructure. However, such facilities are required to successfully complete a warranty and establishment period before the O&M is transferred from the Permittee of the Public Works Permit to the City.

For public facilities, the required O&M submittal to BES is a [Public Works O&M Form](#) and an O&M Plan. The [O&M Form](#) identifies the Permittee responsible for maintenance and the O&M Plan establishes the maintenance practices required to establish the vegetative portions of the stormwater facility. For green street facilities, use of the Standard O&M Plan is required (see [Section 3.2.1.1](#)). For all other facility types, a site-specific O&M Plan must be developed and submitted prior to construction as part of the review process. This plan will be in effect during the warranty period when the Permittee is responsible for O&M.

The O&M Plan must include acceptable permanent access accommodations for the City to perform both warranty period inspections and long-term O&M activities.

Maintenance by Environmental Services' Watershed Revegetation Program

Public Works Permit applicants may enter into an agreement with the BES Watershed Revegetation Program (WRP) to provide warranty-period vegetation services for green street facilities. The agreements typically include:

- Irrigation
- Vegetation monitoring and replacement of dead plants
- Sediment removal
- Treatments specific to the agreement for maintenance

Projects where the WRP is contracted to provide vegetation services will be exempt from vegetation inspections, but the Permittee is still responsible during the warranty period for other permit elements such as structural components and inlets. Permittees do not need to submit an O&M Plan but must still complete the [O&M Form](#) and maintain a Public Stormwater Facility Inspection Log.

Contact the WRP at 503-823-2024 for further information.

3.2.1 Establishment and Maintenance Requirements

The Permittee (generally a contractor or developer) that builds stormwater management facilities under a Public Works Permit is responsible for maintaining all site stormwater management features during the two-year warranty maintenance period. This includes maintaining, repairing, and/or replacing the associated vegetative components; any structural or functional repairs; and the general maintenance of the facility as outlined in the O&M Plan.

Facilities must be checked regularly for the maintenance needs identified in the O&M Plan. If the City finds deficiencies in the work during the warranty maintenance period, a deficiency list will be sent to the Permittee who will then have 15 days to complete the work after written notice is received. If corrective work is not completed in the required time frame, the City may perform any work necessary to correct deficiencies, and will seek reimbursement from the Permittee through the bond for all costs associated with bringing the stormwater management facility into compliance with permit requirements.

Portland City Code requires the Permittee to keep a Public Stormwater Facility Inspection Log that notes all inspection dates, the facility components inspected, and any maintenance or repairs made. The logs must document deficiencies and corrective actions taken to keep structural and vegetative components functioning as designed. The City may accept work orders, invoices, or receipts as supporting detail for an inspection and maintenance log. If deficiencies are identified by City staff during the warranty maintenance period, the Public Stormwater Facility Inspection Log and other documentation must be presented to determine the frequency and type of maintenance conducted.

Timeline of two-year warranty maintenance activities

After the stormwater management facilities are constructed and planted per the approved plan, the City will issue a Letter of Completion. This letter provides official notification that construction is complete and that the two-year maintenance warranty period has begun.

Release of two-year warranty

The City will issue a letter to the Permittee identifying any deficiencies that must be corrected prior to the end of the maintenance warranty period.

At the end of the 24-month warranty period, if the stormwater management facility has passed all inspections and deficiencies have been corrected as identified by City staff, the warranty maintenance period will end and the stormwater management facility will be turned over to the City for long-term maintenance

STANDARD O&M PLAN for the Warranty Maintenance Period

3.2.1.1. Green Street Facilities including Curb Extensions, Swales, Planters

REGULAR INSPECTIONS

The Permittee named on the Public Works Permit O&M Form is responsible for inspecting each part of the system at least once every three months for the duration of the maintenance warranty period. Inspections must also be made within 48 hours after all major storm events, defined as greater than 1.0 inch of rain in a 24-hour period.

VEGETATION COVER AND HEALTH

Vegetation must be healthy and vigorous at the time of installation. The goal of the two-year maintenance warranty period is to maintain this vigor and health, while controlling undesirable vegetation.

- A survival rate of 90% is required at all times over the two-year warranty period; plant replacement is required if the rate is less than 90%.
- Individual bare spots may be no larger than 10 square feet.
- Plant replacement must occur during the following planting seasons:
- Planting outside the listed planting seasons requires written approval by the City.
- Replant per the permitted plan, or seek approval for substitutions from the plant list in Section 2.4.1.
- Use of fertilizers is not allowed in storm water management facilities during the maintenance warranty period.
- Remove dead or dying vegetation; standing dead (brown) stems of rushes and sedges can be “combed out” by hand or with a spring rake.
- Trimming or cutting of vegetation is allowed to maintain clearance along sidewalks and curb edges only.

PLANTING SEASONS	
SPRING	FEB 1–MAY 1
FALL	OCT 1–DEC 1

WEED CONTROL

A weed is any vegetation not listed on the permitted planting plan.

- Remove weeds entirely, including all roots and root fragments, by hand, before plants set seed.
- No more than 5% coverage by weeds is allowed in a facility at any given time.
- Use of herbicides is not allowed in stormwater management facilities during the maintenance warranty period.

TREE HEALTH

All trees must be healthy and vigorous, with trunk and limbs free from insects, disease, defects, injuries, and decay, throughout the maintenance warranty period.

- Dead, dying, diseased, injured, or otherwise defective trees must be replaced.
- Tree replacement must occur during the following planting seasons:
- Planting outside the listed planting seasons requires written approval by the City.

PLANTING SEASONS	
SPRING	FEB 1–MAY 1
FALL	OCT 1–DEC 1

INFILTRATION

Each facility is designed to drain within 48 hours after the end of a storm event.

A facility with standing water 48 hours after the end of a storm event must be reported to the BES Construction Manager immediately.

EROSION

Erosion within a stormwater facility can reduce infiltration rates, expose plant roots and structures, and clog outlets.

- Maintain soil elevations and grades per plan.
- Significant erosion must be addressed immediately. Notify the BES Construction Manager for guidance.

MULCH

Mulch may be used to inhibit weed growth, retain moisture, reduce soil erosion and compaction, and add nutrients. Mulch may be allowed on a case-by case basis.

- Apply and maintain mulch per plan, or as directed.
- Ensure that no mulch covers plants or comes into contact with tree trunks or woody stems of plants.
- Keep mulch off structures, roadways, shoulders, walks, and lawns.
- Mulch must be fine to medium 100% natural hemlock bark free of dyes and pesticides.
- Submit detailed vendor and mulch product information for review and approval prior to placement.

LEAF REMOVAL

Excess leaf material in a facility may impede conveyance and infiltration, reduce storage capacity, and increase nutrient loading.

- During regular maintenance visits, and more frequently during the fall season, remove leaf material from the facility, including inlets, outlets, forebays, overflow structures, and curbs.
- Clean the street gutter line to 10 feet upstream of the curb inlets, or the nearest driveway apron, to maintain open inlets between visits.

IRRIGATION

All permitted vegetation requires irrigation during the maintenance warranty period to maintain health and vigor. Even drought tolerant plants need water during warm, dry months, particularly during the first two years while plants are getting established, and during times of unusual heat and drought.

- Irrigation is required once each week (minimum) during the summer irrigation season.
- Irrigation is required once every two weeks (minimum) during the spring and fall irrigation seasons (*see right*):
- Use portable tanks, truck water systems, or temporary above-ground irrigation devices.
- Tree watering bags may be used from May 15th- October 1st, but must be removed every fall.

IRRIGATION MINIMUMS		
SPRING	MAY 15 – JUNE 30	once every two weeks
SUMMER	JULY 1–AUG 31	once every week
FALL	SEPT 1 –OCT 1	once every two weeks

SEDIMENT REMOVAL

Sediment is mineral or organic matter deposited into the facility. Excess sediment in a facility can impede conveyance and infiltration, reduce storage capacity, and bury vegetation.

- Conveyance capacity must be maintained at least 75% (minimum) at all times.
- Sediment must be removed from inlets and forebays during each inspection and after every major storm.
- Remove accumulated sediment from inside the facility during routine maintenance visits.

TRASH AND DEBRIS REMOVAL

Excess trash and debris in a facility may impede conveyance and infiltration.

- Trash and debris must be removed during every site visit.

3.2.2 Manufactured Stormwater Treatment Technologies

Facility-specific operations and maintenance (O&M) plans are required for manufactured stormwater treatment technologies (MSTT). O&M for manufactured technologies is specific to the device and is critical to long-term pollution reduction performance. Design and installation of individual devices is done in partnership with the manufacturer, who provides a letter confirming that the device has been sited, sized, and designed appropriately. The project designer is responsible for confirming that any conditions of use are met.

Each MSTT has a recommended O&M guide or plan provided by the manufacturer that includes minimum inspection frequencies, maintenance triggers, and typical media replacement frequencies. The O&M guide for any proposed public MSTT must be submitted along with the Public Works Stormwater Operations and Maintenance Form. The Public Works Permittee (generally the construction contractor or developer) is responsible for O&M of any MSTT through the end of the warranty period.

Changes to pollutant loading or site conditions, spills, localized erosion, or large storm events may require increasing maintenance frequencies in order to maintain pollution reduction performance. Minimum maintenance practices or frequencies may need to be modified in order to maintain MSTT functionality and to meet warranty requirements.

Even if manufacturers include a maintenance plan or warranty with device purchase, ultimate responsibility for the MSTT O&M lies with the Permittee of the Public Works Permit. It is the Permittee's responsibility to ensure and document that maintenance is performed as per any maintenance agreement or while under warranty.

3.2.3 Submittal Requirements for Future BES Facilities

These submittal requirements are specific to facilities constructed as public improvements, or under a Public Works Permit, that will become public stormwater facilities owned and managed by BES following a 2-year warranty maintenance period. The facilities may include Green Street facilities, regional or neighborhood facilities, and manufactured stormwater treatment technologies. Adequate operations and maintenance is essential during the warranty maintenance period, prior to BES taking responsibility for long-term maintenance.

How to Prepare and Submit a Public Works O&M Submittal

The City of Portland requires the following documents for all stormwater management facilities in the right-of-way:

- A Public Works O&M Form
- An O&M Plan (unless the Watershed Revegetation Program will be maintaining the vegetative components of the facility)
- A Site Plan
- A Planting Plan

BES must review and approve the submittals prior to construction. Maintaining the stormwater management facilities shown on the site plan is a required condition of the City's approval of the project. These submittals are required in all circumstances. The required documents must be submitted in electronic format to the BES construction manager or permit reviewer identified in the Public Works Form.

O&M Form

The Public Works O&M Form must include the Public Works Permit and project information, the name of the Permittee (Public Works Permit applicant, generally the contractor or developer), and a signature acknowledging responsibility for the two-year warranty maintenance period, including structural components and plant establishment, as appropriate.

O&M Plan

The O&M plan must identify all the maintenance requirements needed to properly establish future public facilities. BES's Watershed Revegetation Program staff will inspect facilities to assure compliance with this requirement.

If the Watershed Revegetation Program is maintaining the vegetative components of the facility, no O&M Plan is required.

For stormwater facilities designed under the Presumptive Approach (generally, green streets such as curb extensions, swales, and planters), the Standard O&M Plan for Green Streets must be used (see [Section 3.2.1.1 Green Street Facilities](#)). If the project consists of regional or neighborhood facilities or manufactured stormwater treatment technologies, an O&M Plan must be developed and submitted for review that meets the O&M requirements of Chapter 3.

Site Plan

The site plan must show the locations of the following:

- Existing utilities, including overhead and underground utilities.
- Nearby fixtures including hydrants, benches, and bike racks.

The site plan must be attached to the [O&M Form](#). The permit number and sheet number can be used to reference the location of the information within the Public Works Permit as long as the information on the sheet meets the Site Plan requirements. A single plan can be submitted incorporating the elements of the Site Plan and Planting Plan, but it must include all of the elements listed for both plans.

Planting Plan

The planting plan must:

- Show where the plants are to be placed.
- Provide labels so the contractor can determine where the plants should be positioned and the city inspector can check compliance.
- Include a planting legend with the following information: plant species (both botanical and common names), size at installation, spacing, and quantities.
- List the square footage of the facility.

The planting plan must be attached to the [O&M Form](#). The permit number and sheet number can be used to reference the location of the information as long as it meets the Planting Plan requirements. A single plan can be submitted incorporating the elements of the Site Plan and Planting Plan, but it must include all of the elements listed for both plans.



CITY OF PORTLAND
Stormwater
Management
Manual

PUBLIC WORKS O&M FORM

FOR FUTURE BUREAU OF ENVIRONMENTAL SERVICES (BES) FACILITIES

For green streets facilities, regional or neighborhood facilities, and manufactured stormwater treatment facilities constructed as public works improvements.

PLEASE FILL THIS FORM OUT COMPLETELY.

Detailed information about submittal requirements is contained in Section 3.2.3. For assistance in completing this form, consult with the BES Revegetation Program at 503-823-2024.

A complete O&M submittal consists of this form with a Site Plan, Planting Plan, and O&M Plan (if required).

(for official use only)

Received by: _____

Date: _____

Deemed complete on: _____

PROJECT INFORMATION

BES Job Number: _____

Job Description: _____

Job Location: _____

BES Construction Manager Name and Telephone Number: _____

PUBLIC WORKS PERMIT APPLICANT

(Permittee)

Name: _____

Phone: _____

Email: _____

Mailing Address: _____

City/State/Zip: _____

MAINTENANCE CONTRACTOR

(if different than the Permittee)

Name: _____

Phone: _____

Email: _____

Mailing Address: _____

City/State/Zip: _____

ATTACHMENTS *(ALL must be checked and attached)*

- Site Plan (or reference BES Permit # _____, Sheet # _____)
- Planting Plan (or reference BES Permit # _____, Sheet # _____)
- O&M Plan (For Green Street projects, use the Standard O&M Plan for *Green Street Facilities*)

All structural components, including inlets, drain pipes, check dams, and liners, must freely convey stormwater and be repaired or replaced if damaged over the duration of the warranty period. I accept, agree to, and assume responsibility for compliance to the terms and conditions contained in this form and the O&M Plan.

Signature: *(Permittee)* _____ **Date:** _____

Print Name: _____

Definitions

Note: *The following definitions apply to terms used in this manual and are intended to supplement City Code Chapters 17.32 and 17.38.*

Applicant: Any person, company, or agency that applies for a permit through the City of Portland. Includes all parties represented by the applicant.

Approved Receiving System (Discharge Point): Any system or route of conveyance approved by BES to receive stormwater runoff or other discharges. Receiving systems include, but are not limited to, groundwater; onsite, offsite, or public stormwater, sanitary, or combined sewers; and waters of the state.

BDS: Bureau of Development Services, City of Portland.

BES: Bureau of Environmental Services, City of Portland.

Best Management Practices (BMPs): Operational, maintenance and other practices that prevent or reduce environmental, health or safety impacts. BMPs include structural controls, modification of facility processes, and operating and housekeeping pollution control practices.

Capacity: The flow volume or rate that a specific facility (e.g., basin, pipe, pond, vault, swale, ditch, or drywell.) is designed to safely contain, receive, convey, reduce pollutants from, or infiltrate to meet a specific performance standard.

Catch Basin: A structural facility located just below the ground surface, designed to collect and convey stormwater runoff to an onsite stormwater system or offsite discharge point. A catch basin has a grated lid, a sumped bottom, and outlet pipe (with a downturned 90 degree elbow or snout) to trap coarse sediment and oil. See [Section 2.3.5](#) for typical design.

Channel: The portion of a drainageway that demonstrates evidence of the conveyance of water. It is the depression between the banks worn by the regular and usual flow of water. The channel need not contain water year-round.

Check Dam: A low structure or weir placed across an open channel to control water depth or velocity, or to control channel erosion.

Combined Sewers: A sewer designed to convey both sanitary sewage and stormwater.

Connection: The connection of drainage disposal lines from all development on a property to the public sewer and drainage system.

Culvert: A hydraulically short conduit, open on both ends, generally used to convey stormwater runoff through a roadway or an embankment and typically constructed without manholes, inlets or catch basins.

Combined Sewer Overflow (CSO): A discharge of a mixture of sanitary sewage and stormwater at a point in the combination sewer system designed to relieve surcharging flows.

Department of Environmental Quality (DEQ): Oregon Department of Environmental Quality.

Design Storm: Design storms are a combination of the design storm return period (which refers to the frequency) and the storm duration (which defines the rainfall depth or intensity). A prescribed hyetograph and total precipitation amount (for a specific duration recurrence frequency) are used to estimate runoff for a hypothetical storm for the purposes of analyzing existing drainage, designing new drainage facilities, or assessing other impacts of a proposed project on the flow of surface water.

Design Water Surface Elevation (Overflow Elevation): The elevation at the upper limit of the maximum depth and the lower limit of the freeboard, which corresponds to the overflow elevation. It can be considered the initial outlet elevation or overtopping elevation of the facility where an outlet is not included. Each cell of the facility may have a different design water surface elevation. The design water surface elevation can be relative to the final discharge point, a known actual elevation onsite, or can be set to zero.

Detention Facility: A facility designed to receive and hold stormwater and release it at a slower rate, usually over a number of hours. The facility may provide minimal or no volume reduction.

Detention Tank, Vault, or Oversized Pipe: A structural subsurface facility used to provide flow control for a particular drainage basin.

Development: Any human-induced change to improved or unimproved real estate, whether public or private, including but not limited to construction, installation, or expansion of a building or other structure; land division; street construction; drilling; and site alteration such as dredging, grading, paving, parking or storage facilities,

excavation, filling, or clearing. Development encompasses both new development and redevelopment.

Development Footprint: The new or redeveloped area covered by buildings or other roof structures and other impervious surface areas that 1) does not allow stormwater to percolate into the ground, such as roads, parking lots, and sidewalks, or 2) is covered by pervious paving materials and systems.

Discharge Point (Disposal): The connection point or destination for a discharge leaving a site.

Discharge Rate: The rate of flow expressed in cubic feet per second (cfs).

Disturbance. An action that causes an alteration to soil or vegetation. The action may create temporary or permanent disturbance. Examples include development, exterior alterations, exterior improvements, demolition and removal of structures and paved areas, cutting, clearing, damaging, or removing native vegetation.

Disturbance Area. The area where all temporary and permanent disturbance occurs. For new development the disturbance area must be contiguous. Native vegetation planted for resource enhancement, mitigation, remediation, and agricultural and pasture lands is not included. The disturbance area may contain two subareas, the permanent disturbance area and the temporary disturbance area:

- **Permanent Disturbance Area.** The permanent disturbance area includes all areas occupied by existing or proposed structures or exterior improvements. The permanent disturbance area also includes areas where vegetation must be managed to accommodate overhead utilities, existing or proposed non-native planting areas, and roadside areas subject to regular vegetation management to maintain safe visual or vehicle clearance.
- **Temporary Disturbance Area.** The temporary disturbance area is the portion of the site to be disturbed for the proposed development but that will not be permanently occupied by structures or exterior improvements. It includes staging and storage areas used during construction and all areas graded to facilitate proposed development on the site, but that will not be covered by permanent development. It also includes areas disturbed during construction to place underground utilities, where the land above the utility will not otherwise be occupied by structures or exterior improvements.

Drainage Basin: A defined area that contributes to sanitary, stormwater or combined sewage flows to an approved connection point.

Drainage: Waters generated at or conveyed through a particular site. Drainage is predominantly surface runoff generated from rainfall. Groundwater naturally occurring at the surface (such as seeps or springs) or pumped to the surface shall be considered drainage.

Drainage Reserve: The regulated area adjacent to and including a drainageway that is preserved in a natural state to protect the hydrology and water quality of the drainageway.

Drainageway: A constructed or natural channel or depression which at any time collects and conveys water. A drainageway and its reserve area function together to manage flow rate, volume and water quality.

Driveway: The area that provides vehicular access to a site. A driveway begins at the property line and extends into the site. In parking areas, the driveway does not include vehicular parking, maneuvering, or circulation areas.

Drywell: A subsurface structure (e.g. cylinder or vault) with perforated sides and/or bottom, used to infiltrate stormwater into the ground. A drywell is a UIC by DEQ definition.

Ecoroof: A lightweight low-maintenance vegetated roof system consisting of waterproofing material, growing medium, and vegetation; used in place of or over the top of a conventional roof. Ecoroofs provide stormwater management by capturing, filtering, and evaporating rainfall.

Facial Challenge: A challenge to a requirement that is based on an argument that the requirement cannot be applied fairly or reasonably in any situation. By contrast, an as-applied challenge is one based on an argument that a requirement should not be applied to the challenger's particular situation because of factors that, in the challenger's view, distinguish it from similar situations.

Flow: The rate or volume of water moving within a natural or man-made system. Flow is often measured as a ratio, such as cubic feet per second (cfs).

Flow Control: The practice of limiting the release of peak flow rates and volumes from a site. Flow control is intended to protect downstream properties, infrastructure, and natural resources from the increased stormwater runoff peak flow rates and volumes resulting from development.

Flow Control Structure: A device used to delay or divert a calculated amount of stormwater to or from a stormwater management facility.

Freeboard: The vertical distance between the design water surface elevation (overflow elevation) and the elevation at which overtopping of the structure or facility that contains the water would occur.

Geotextile: A woven or non-woven water-permeable material, generally made of synthetic products such as polypropylene, used in stormwater management and erosion and sediment control applications to trap sediment or to prevent fine soil particles from clogging the aggregates.

Green Street: A vegetated stormwater management facility located within the planting strip or other portion of public rights-of-way.

Groundwater: Subsurface water that occurs in soils and geological formations that are fully saturated. Groundwater fluctuates seasonally and includes perched groundwater.

Growing Medium: Growing medium supports plants and microorganisms that improve the function of vegetated stormwater facilities. Growing medium may include stormwater facility blended soil, blended topsoil, or native soils. See the individual facility design criteria and details for requirements in private and public stormwater facilities.

Impervious Surface: Any surface that has a runoff coefficient greater than 0.8 (as defined in the City's [Sewer and Drainage Facilities Design Manual](#)). Types of impervious surface include rooftops, traditional asphalt and concrete parking lots, driveways, roads, sidewalks, and pedestrian plazas. Slatted decks and gravel surfaces are considered pervious unless they cover impervious surfaces or gravels are compacted to a degree that causes their runoff coefficient to exceed 0.8.

Infiltration: The percolation of water into the ground. Infiltration is often expressed as a rate (inches per hour), which is determined through an infiltration test.

Inlet: An inlet means: 1) A structure located just below the ground surface designed to collect stormwater runoff from paved surfaces such as streets and parking lots that have no sumped sediment storage or inverted pipes to capture pollutants. See [Section 2.3.5](#) for typical details. AND 2) The entry point, such as downspouts, piping, or curb cuts, into an onsite stormwater management system or discharge point.

Manufactured Stormwater Treatment Technology: A proprietary stormwater management facility structural facility or device. See [Chapter 2](#) for design approach information or [Section 2.4.8](#) for submittal requirements for manufacturers seeking to be on the approved list.

Maximum Depth (Storage Depth): The greatest vertical distance between the design water surface elevation (overflow elevation) and the top of the growing

medium of a surface facility or the base of a subsurface facility, which creates a reservoir capable of providing safe storage capacity of stormwater.

Municipal Separate Storm Sewer System (MS4): A conveyance or systems of conveyances such as municipal streets, catch basins, curbs, gutter, ditches, manmade channels or storm drains owned by the City of Portland designed or used for collection or conveyance of stormwater

Open Channel: A fluid passageway that allows part of the fluid to be exposed to the atmosphere.

Operations and Maintenance (O&M): The continuing activities required to keep stormwater management facilities and their components functioning in accordance with design objectives.

Outfall: A location where collected water is discharged. Outfalls can include discharge from stormwater management facilities, drainage pipe systems, and constructed open channels.

Overflow: Excess volume of stormwater or wastewater that exceeds the storage or conveyance capacity of a facility or system component and causes a release of flow to another facility, system component or the environment.

Partial Infiltration: When the total infiltration design storm (or another specified design storm as required) is unable to be completely percolated into the ground.

Parking Area: The area of a site devoted to the temporary or permanent storage, maneuvering, or circulation of motor vehicles. Parking areas do not include driveways or areas devoted exclusively to non-passenger loading.

PBOT: Portland Bureau of Transportation

Permit: An official document issued by the Director authorizing performance of a specified activity.

Pervious: Any surface determined to have a runoff coefficient less than 0.8; a surface modified in a way to encourage infiltration of water (as defined in the City's [Sewer and Drainage Facilities Design Manual](#)).

Pervious Pavement (aka Porous Pavement or Permeable Pavement): Alternative pavement systems that allow water to percolate into subsurface drainage systems or the ground. Examples include permeable pavers, pervious asphalt, and pervious concrete systems.

Planter: A structural facility filled with topsoil and gravel and planted with vegetation. The stormwater planter receives runoff from impervious surfaces, which is filtered and retained for a period of time. Planters may be further classified by their ability to infiltrate. An infiltration planter has an open bottom, allowing water to infiltrate into the ground. A flow-through planter has an overflow that must be directed to an acceptable discharge point. Flow-through planters may have an impervious or sealed bottom, either through a waterproof liner or a poured concrete base. Site conditions will determine appropriate facility selection.

Pollutant: An elemental or physical material that can be mobilized or dissolved by water or air and could create a negative impact to human health or the environment.

Pollution Reduction (Water Quality): The Pollution Reduction storm event is representative of 90% of the average annual rainfall and is used to size facilities for the pollution reduction stormwater management requirement. Also known as the water quality storm.

Pollutants of Concern: Constituents identified by DEQ or BES as having the potential to have a negative impact on the receiving system, including surface waters, groundwater, the wastewater collection system, or the wastewater treatment plant. Pollutants of concern can include suspended solids, metals, nutrients, bacteria and viruses, organics, volatiles, semi-volatiles, floatable debris, and increased temperatures.

Practicable: Available and capable of being done, as determined by the BES Director, after taking into consideration cost, resources, existing technology, and logistics in light of overall project purpose.

Presumptive Approach Calculator (PAC): Calculation tool used to size vegetated stormwater facilities.

Public Facility: A street, right-of-way, sewer, drainage, stormwater management, or other facility that is either currently owned by the City or will be conveyed to the City for maintenance responsibility after construction. A new stormwater management facility that receives direct stormwater runoff from a public right-of-way becomes a public (City-maintained) facility unless the right-of-way is not part of the City's road maintenance system.

Public Improvement: An improvement of, on, over, or under property owned or controlled by the City, or property to be controlled by the City upon plat and easement recording for approved land divisions, by construction, reconstruction,

remodeling, repair or replacement, when no property is intended to be assessed any portion of the improvement cost.

Public Works Project: Any project performed or conducted by local, state, or federal governments that result in the construction of a Local Improvement or a Public Improvement.

Rainwater Harvesting: The collection and use of rainwater or stormwater runoff for water use purposes such as irrigation and toilet flushing. A facility that harvests rainwater is considered a stormwater facility only if the facility has water quality or flow control benefit, as determined by BES.

Rational Method: The method used to estimate the peak rate of runoff from a drainage basin, using the formula: $Q=CiA$. Q is the peak discharge, cubic feet per second; C is the runoff coefficient; i is the rainfall intensity, inches per hour; and A is the drainage area, acres (as defined in the City's [Sewer and Drainage Facilities Design Manual](#)).

Redevelopment: Any development that requires demolition or complete removal of existing structures or impervious surfaces at a site and replacement with new impervious surfaces.

Repair: Work performed to patch, replace components, replace or rehabilitate entire facilities that serve the City's sewer and drainage system.

Reservoir: The temporarily stored volume of runoff prior to overflow. For vegetated surface facilities it is defined as the volume between the top of the growing medium, the design water surface elevation (overflow elevation), and the edges of the facility (whether sloped or vertical). In a sedimentation chamber, it is defined as the volume of runoff stored prior to discharge to the receiving system.

Retention Facility: A facility designed to receive and hold stormwater runoff so that some volume of stormwater that enters the facility is not released offsite. Retention facilities permanently retain a portion of the water onsite, where it infiltrates, evaporates, or is absorbed by surrounding vegetation.

Retrofit: Installation of a new facility or system components to manage stormwater or wastewater flows.

Roadway: Any paved surface used to carry vehicular traffic (cars/trucks, forklifts, farm machinery, or any other large machinery).

Runoff Coefficient: A unitless number between zero and one that relates the average rate of rainfall over a homogenous area to the maximum rate of runoff, as defined in the City's [Sewer and Drainage Facilities Design Manual](#).

Safety Factor: A sizing multiplier that evaluates the risks and values of specific conditions, including the failure mode of the construction material, unexpected construction deficiencies, and potential cost of system failure. The safety factor is applied to the maximum performance limit to calculate a risk-based design value used for sizing facilities. A safety factor must be used to provide reasonable assurance of acceptable long-term system performance.

Sand Filter: A structural pollution reduction or flow control facility using a layer of sand and optional vegetation to manage stormwater runoff.

Santa Barbara Urban Hydrograph (SBUH): A hydrologic method used to calculate runoff hydrographs.

Seasonally High Groundwater Level: The highest level that the permanent groundwater table or perched groundwater may reach on a seasonal basis.

Site: Any lot or parcel of land or contiguous combination where development occurs. For utility lines, trenches or other similar work, the site includes only the disturbance area directly related to the linear work activity.

Soakage Trench: A subsurface infiltration stormwater management facility that includes a perforated pipe laid in drain rock. A soakage trench is a UIC by DEQ definition.

Stormwater: Water that originates as precipitation on a particular site, basin, or watershed. Also referred to as runoff.

Stormwater Facility Landscaping (Landscaping): The vegetation (plantings), topsoil, rocks, and other surface elements associated with stormwater management facility design.

Stormwater Management: Techniques used to reduce pollutants from, detain, retain, or provide a discharge point for stormwater runoff that best preserves or mimics the natural hydrologic cycle. Stormwater management reduces combined sewer overflows and basement sewer backups, and helps meet the capacity of existing infrastructure.

Stormwater Management Facility: A facility or other technique used to reduce the volume, flow rate or pollutant content of stormwater runoff. Stormwater facilities

may reuse, collect, convey, detain, retain, or provide a discharge point for stormwater runoff.

Stormwater Retrofit: Installation of a new stormwater facility to treat stormwater from existing impervious area, including, but not limited to, roofs, patios, walkways, and driving or parking surfaces.

Sump: 1) A large public drywell used to infiltrate stormwater from public streets. Sumps are generally 48 inches in diameter and 30 feet deep. 2) Any volume of a facility below the point of outlet in which water or solids can accumulate.

Surcharge: 1) A flow condition when the downstream hydraulic capacity is less than the upstream inflow causing water to back up and rise above the inside crown of a pipe or facility. 2) The greatest measured distance from the water surface to the pipe crown.

Surface Infiltration Facility: A vegetated facility designed to receive and infiltrate stormwater runoff at the ground surface to meet stormwater infiltration/discharge requirements.

Tenant Improvements: Structural upgrades made to the interior or exterior of buildings.

Temporary Structure: A structure that is a separate and distinct entity from all other structures for a continuous period of three years or less. A temporary structure must be created and removed in its entirety, including impervious area associated with the structure, within three years. Paved areas such as parking lots that are developed alongside structures are not considered temporary for the purpose of this manual.

Time of Concentration (T of C or TOC): The amount of time it takes stormwater runoff to travel from the most distant point (measured by travel time) on a particular site or drainage basin to a particular point of interest.

Total Suspended Solids (TSS): Total suspended matter that either floats on the surface or is suspended in water or wastewater and that is removable by laboratory filtering in accordance with 40 CFR Table B.

Underground Injection Control (UIC): Defined by DEQ as any system, structure, or activity that is intended to discharge fluids below the ground surface such as sumps, drywells, and soakage trenches.

Vegetated Facilities: Stormwater management facilities that rely on plantings as an integral component of their functionality.

Vegetated Filter: A gently sloping, densely vegetated area used to filter, slow, and infiltrate sheetflow stormwater.

Vegetated Infiltration Basin (Rain Garden): A vegetated facility that temporarily holds and infiltrates stormwater into the ground.

Vegetated Swale (Bioswale): A long, narrow, vegetated channel used to collect, convey and reduce pollutants from stormwater runoff. Check dams are used to slow runoff, settle sediment, and improve infiltration and pollution reduction.

Water Body: Coastal waters, rivers, sloughs, continuous and intermittent streams and seeps, ponds, lakes, aquifers, and wetlands.

Water Quality Limited: Waters identified by DEQ that do not meet water quality standards. Total Maximum Daily Load (TMDL) must be developed for these waters to satisfy Clean Water Act (CWA) requirements. The most recent EPA-approved Section 303(d) list for Oregon can be found at www.deq.state.or.us/wq/assessment/assessment.htm.

Water Table: The upper surface of an unconfined water body, the surface of which is at atmospheric pressure and fluctuates seasonally. The water table is defined by the levels at which water stands in wells that penetrate the water body (City Water Pollution Control Facility Permit).

Wellhead Protection Area: A drinking water source area where additional groundwater protections are in place to secure the City's drinking water supplies and protect public health. The City regulates the storage, use, and transportation of chemicals in these sensitive areas, and more stringent stormwater management standards may apply. Additional information is available at <http://www.portlandoregon.gov/water/29890>.

Wet Pond: A vegetated basin with a permanent pool of water, used to provide pollution reduction for a particular drainage basin. The permanent pool of water provides a storage volume for pollutants to settle out and extended wet detention ponds have additional storage capacity for flow control.

Wetland: An area that is inundated or saturated by surface water or groundwater at a frequency and duration sufficient to support, and that under normal circumstances does support, a prevalence of vegetation typically adapted for life in saturated soil

conditions. Wetlands include swamps, marshes, bogs, and similar areas, except those constructed as pollution reduction or flow control facilities.

Appendix A. Stormwater Design Methodologies

This appendix describes many of the methodologies and assumptions used in establishing standards for the various design approaches.

Appendix A.1 Santa Barbara Urban Hydrograph Method	2
Appendix A.2: Simplified Approach Sizing Calculations.....	10
Appendix A.3 Stormwater Pollution Reduction Storm.....	14
Appendix A.4 Presumptive Approach Calculator Technical Framework.....	23

A.1 Santa Barbara Urban Hydrograph Method

The Santa Barbara Urban Hydrograph (SBUH) method was developed by the Santa Barbara County Flood Control and Water Conservation District to determine a runoff hydrograph for an urbanized area. It is a simpler method than some other approaches, as it computes a hydrograph directly without going through intermediate steps (i.e., a unit hydrograph) to determine the runoff hydrograph.

The SBUH method is a popular method for calculating runoff, since it can be done with a spreadsheet or by hand relatively easily. The SBUH method is the method approved by the Bureau of Environmental Services (BES) for determining runoff when doing flow control calculations.

Elements of the SBUH Method

The SBUH method depends on several variables:

- Pervious (A_p) and impervious (A_{imp}) land areas
- Time of concentration (T_c) calculations
- Runoff curve numbers (CN) applicable to the site
- Design storm

These elements shall all be presented as part of the submittal process for review by BES staff. In addition, maps showing the pre-development and post-development conditions shall be presented to BES to help in the review.

Land Area

The total area, including the pervious and impervious areas within a drainage basin, shall be quantified in order to evaluate critical contributing areas and the resulting site runoff. Each area within a basin shall be analyzed separately and their hydrographs combined to determine the total basin hydrograph. Areas shall be selected to represent homogenous land use/development units.

Time of Concentration

Time of concentration, T_c , is the time for a theoretical drop of water to travel from the furthest point in the drainage basin to the facility being designed. (In this case, T_c is derived by calculating the overland flow time of concentration and the channelized flow time of concentration.) T_c depends on several factors, including

ground slope, ground roughness, and distance of flow. The following formula for determining T_c is found in BES's [Sewer and Drainage Facilities Design Manual](#).

Formulas

$$T_c = T_{t1} + T_{c2} + T_{c3} + \dots + T_{cn}$$

$$T_t = L/60V \quad (\text{Conversion of velocity to travel time})$$

$$T_t = \frac{0.42(nL)^{0.8}}{1.58(s)^{0.4}} \quad (\text{Manning's kinematic solution for sheet flow less than 300 feet})$$

Shallow concentrated flow for slopes less than 0.005 ft/ft. (For steeper slopes, consult [Sewer and Drainage Facilities Design Manual](#)):

$$V = 16.1345(s)^{0.5} \quad (\text{Unpaved surfaces})$$

$$V = 20.3282(s)^{0.5} \quad (\text{Paved surfaces})$$

Where,

T_t = travel time, minutes

T_c = total time of concentration, minutes (minimum T_c = 5 minutes)

L = flow length, feet

V = average velocity of flow, feet per second

n = Manning's roughness coefficient for various surfaces

(see [Sewer and Drainage Facilities Design Manual](#))

s = slope of the hydraulic grade line (land or watercourse), feet per foot

When calculating T_c , the following limitations apply:

- Overland sheet flow (flow across flat areas that does not form into channels or rivulets) shall not extend for more than 300 feet.
- For flow paths through closed conveyance facilities such as pipes and culverts, standard hydraulic formulas shall be used for establishing velocity and travel time. (See the [Sewer and Drainage Facilities Design Manual](#) for more data on pipe flow rates and velocities.)
- Flow paths through lakes or wetlands may be assumed to be zero (i.e. $T_c = 0$).

Runoff Curve Numbers

Runoff curve numbers were developed by the Natural Resources Conservation Service (NRCS) after studying the runoff characteristics of various types of land.

Curve numbers (CN) were developed to reduce diverse characteristics such as soil type, land usage, and vegetation into a single variable for doing runoff calculations. The runoff curve numbers approved by BES for water quantity/quality calculations are included as Table A-2, Table A-3, and Table A-4 of this appendix.

The curve numbers presented in Table A-2, A-3 and Table A-4 are for wet antecedent moisture conditions. Wet conditions assume previous rainstorms have reduced the capacity of soil to absorb water. Given the frequency of rainstorms in the Portland area, wet conditions are most likely, and give conservative hydrographic values. Hydrologic soil group descriptions references in Tables A-2, A-3 and A-4 are found in Table A-5.

Design Storm

The SBUH method also requires a design storm to perform the runoff calculations. For flow control calculations, BES uses a NRCS Type 1A 24-hour storm distribution. This storm is shown in Table A-1 and Figure A-1. The depth of rainfall for the 2 through 100-year storm events is shown below in Table A-1.

Table A-1. 24-Hour Rainfall Depths at Portland Airport

Reoccurrence Interval (Years)	24-Hour Depth (Inches)
2	2.4
5	2.9
10	3.4
25	3.9
100	4.4

Table A-2. Curve Numbers for Urban Areas

Cover type and hydrological condition	Average percent impervious area	Curve Numbers by Hydrologic Soil Group			
		A	B	C	D
Open Space (lawns, parks, golf courses, cemeteries, etc.):					
Poor condition (grass cover <50%)		68	79	86	89
Fair condition (grass cover 50-75%)		49	69	79	84
Good condition (grass cover >75%)		39	61	74	80
Impervious Area:					
Paved parking lots, roofs, driveways, etc. (excluding right-of-way)		98	98	98	98
Streets and roads:					
Paved; curbs and storm sewers (excluding right-of-way)		98	98	98	98
Paved; open ditches (including right-of-way)		83	89	92	93
Gravel (including right-of-way)		76	85	89	91
Dirt (including right-of-way)		72	82	87	93
Urban Districts:					
Commercial and business	85	85	92	94	95
Industrial	72	81	88	91	93
Residential districts by average lot size:					
1/8 acre or less (town houses)	65	77	85	90	82
1/4 acre	38	61	75	83	87
1/3 acre	30	57	72	81	86
1/2 acre	25	54	70	80	85
1 acre	20	51	68	79	84
2 acres	12	46	65	77	82

Soil Conservation Service, Urban Hydrology for Small Watersheds, Technical Release 55, pp. 2.5-2.8, June 1986.

Table A-3. Runoff Curve Numbers for Other Agricultural Lands

Cover type and hydrological condition	Hydrologic Condition	Curve Numbers by Hydrologic Soil Group			
		A	B	C	D
Pasture, grassland, or range-continuous forage for grazing: <50% ground cover or heavily grazed with no mulch 50 to 75% ground cover and not heavily grazed >75% ground cover and lightly or only occasionally grazed	Poor	68	79	86	89
	Fair	49	69	79	84
	Good	39	61	74	80
Meadow-continuous grass, protected from grazing and generally mowed for hay		30	58	71	78
Brush-weed-grass mixture with brush as the major element: <50% ground cover 50-75% ground cover >75% ground cover	Poor	48	67	77	83
	Fair	35	56	70	77
	Good	30	48	65	73
Woods-grass combination (orchard or tree farm)	Poor	57	73	82	86
	Fair	43	65	76	82
	Good	32	58	72	79
Woods Forest litter, small trees, and brush are destroyed by heavy grazing or regular burning Woods are grazed by not burned, and some forest litter covers the soil Woods are protected from grazing and litter and brush adequately cover the soil	Poor	45	66	77	83
	Fair	36	60	73	79
	Good	30	55	70	77

Soil Conservation Service, Urban Hydrology for Small Watersheds, Technical Release 55, pp. 2.5-2.8, June 1986.

Table A-4. Runoff Curve Numbers for Stormwater Facilities Designed Under the Simplified Approach

Stormwater Facility Type	Hydrologic Condition	Curve Numbers by Hydrologic Soil Group			
		A	B	C	D
Ecoroof	Good	n/a	61	n/a	n/a
Planter	Good	n/a	48	n/a	n/a
Pervious Pavement	n/a	76	85	89	n/a
Trees (new or existing)	n/a	36	60	73	79

n/a - Does not apply, as design criteria for the relevant mitigation measures do not include the use of this soil type.

**CNs of various cover types were assigned to the Simplified Approaches with similar cover types as follows:

Eco-roof – assumed grass in good condition with soil type B.

Planter – assumed brush-weed-grass mixture with >75% ground cover and soil type B.

Pervious Pavement – assumed gravel.

Trees – assumed woods with fair hydrologic conditions.

Table A-5. NRCS Hydrologic Soil Group Descriptions

NRCS Hydrologic Soil Group	Description
Group A	Soils having a high infiltration rate (low runoff potential) when thoroughly wet. These consist chiefly of deep, well drained to excessively drained sands or gravels. These soils have a high rate of water transmission.
Group B	Soils having a moderate infiltration rate when thoroughly wet. These consist chiefly of moderately deep or deep, moderately well drained or well drained soils that have moderately fine texture to moderately coarse texture. These soils have a moderate rate of water transmission.
Group C	Soils having a slow infiltration rate when thoroughly wet. These consist chiefly of soils that have a layer that impedes the downward movement of water or soils that have moderately fine texture or fine texture. These soils have a slow rate of water transmission.
Group D	Soils having a very slow infiltration rate (high runoff potential) when thoroughly wet. These consist chiefly of clay soils that have a high shrink-swell potential, soils that have a permanent high water table, soils that have a fragipan or clay layer at or near the surface, and soils that are shallow over nearly impervious material. These soils have a very slow rate of water transmission.

To determine hydrologic soil type, consult local USDA Soil Conservation Service Soil Survey.

Figure A-1. NRCS 24-Hour Type 1A Hyetograph

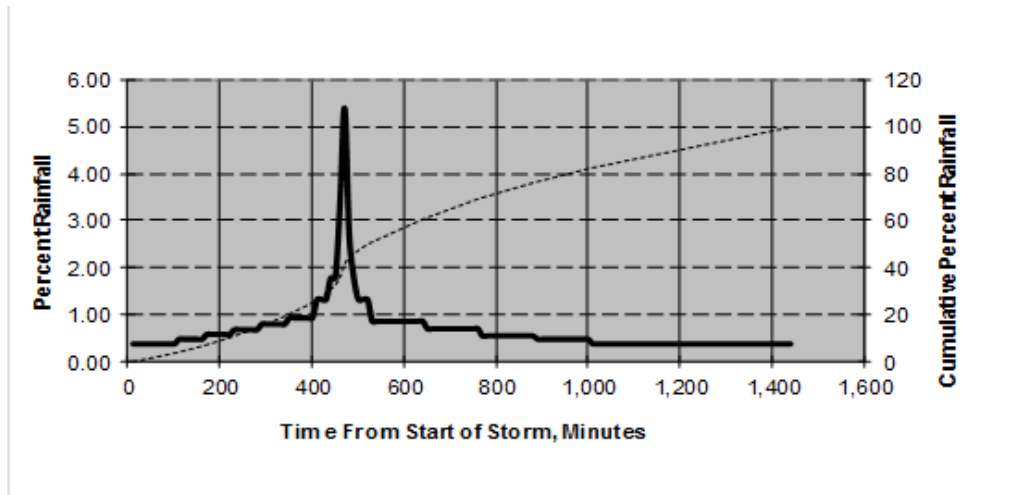

NRCS Type 1A Hyetographic Distribution - For Use In Water Quality/Quantity Design

Time From Start of Storm, Minutes	Cumulative % Rainfall	Time From Start of Storm, Minutes	Cumulative % Rainfall	Time From Start of Storm, Minutes	Cumulative % Rainfall	Time From Start of Storm, Minutes	Cumulative % Rainfall
0 - 10	0.40	360 - 370	0.95	720 - 730	0.72	1080 - 1090	0.40
10 - 20	0.40	370 - 380	0.95	730 - 740	0.72	1090 - 1100	0.40
20 - 30	0.40	380 - 390	0.95	740 - 750	0.72	1100 - 1110	0.40
30 - 40	0.40	390 - 400	0.95	750 - 760	0.72	1110 - 1120	0.40
40 - 50	0.40	400 - 410	1.34	760 - 770	0.57	1120 - 1130	0.40
50 - 60	0.40	410 - 420	1.34	770 - 780	0.57	1130 - 1140	0.40
60 - 70	0.40	420 - 430	1.34	780 - 790	0.57	1140 - 1150	0.40
70 - 80	0.40	430 - 440	1.80	790 - 800	0.57	1150 - 1160	0.40
80 - 90	0.40	440 - 450	1.80	800 - 810	0.57	1160 - 1170	0.40
90 - 100	0.40	450 - 460	3.40	810 - 820	0.57	1170 - 1180	0.40
100 - 110	0.50	460 - 470	5.40	820 - 830	0.57	1180 - 1190	0.40
110 - 120	0.50	470 - 480	2.70	830 - 840	0.57	1190 - 1200	0.40
120 - 130	0.50	480 - 490	1.80	840 - 850	0.57	1200 - 1210	0.40
130 - 140	0.50	490 - 500	1.34	850 - 860	0.57	1210 - 1220	0.40
140 - 150	0.50	500 - 510	1.34	860 - 870	0.57	1220 - 1230	0.40
150 - 160	0.50	510 - 520	1.34	870 - 880	0.57	1230 - 1240	0.40
160 - 170	0.60	520 - 530	0.88	880 - 890	0.50	1240 - 1250	0.40
170 - 180	0.60	530 - 540	0.88	890 - 900	0.50	1250 - 1260	0.40
180 - 190	0.60	540 - 550	0.88	900 - 910	0.50	1260 - 1270	0.40
190 - 200	0.60	550 - 560	0.88	910 - 920	0.50	1270 - 1280	0.40
200 - 210	0.60	560 - 570	0.88	920 - 930	0.50	1280 - 1290	0.40
210 - 220	0.60	570 - 580	0.88	930 - 940	0.50	1290 - 1300	0.40
220 - 230	0.70	580 - 590	0.88	940 - 950	0.50	1300 - 1310	0.40
230 - 240	0.70	590 - 600	0.88	950 - 960	0.50	1310 - 1320	0.40
240 - 250	0.70	600 - 610	0.88	960 - 970	0.50	1320 - 1330	0.40
250 - 260	0.70	610 - 620	0.88	970 - 980	0.50	1330 - 1340	0.40
260 - 270	0.70	620 - 630	0.88	980 - 990	0.50	1340 - 1350	0.40
270 - 280	0.70	630 - 640	0.88	990 - 1000	0.50	1350 - 1360	0.40
280 - 290	0.82	640 - 650	0.72	1000 - 1010	0.40	1360 - 1370	0.40
290 - 300	0.82	650 - 660	0.72	1010 - 1020	0.40	1370 - 1380	0.40
300 - 310	0.82	660 - 670	0.72	1020 - 1030	0.40	1380 - 1390	0.40
310 - 320	0.82	670 - 680	0.72	1030 - 1040	0.40	1390 - 1400	0.40
320 - 330	0.82	680 - 690	0.72	1040 - 1050	0.40	1400 - 1410	0.40
330 - 340	0.82	690 - 700	0.72	1050 - 1060	0.40	1410 - 1420	0.40
340 - 350	0.95	700 - 710	0.72	1060 - 1070	0.40	1420 - 1430	0.40
350 - 360	0.95	710 - 720	0.72	1070 - 1080	0.40	1430 - 1440	0.40

Last revision 7/13/1998 Bureau of Environmental Services, Portland, Oregon.

A.2 Simplified Approach Sizing Calculations

BES staff conducted a technical process to determine facility designs and sizes that would be appropriate for small development sites. The process included a review of technical literature, review of BES monitoring data, calculations, and theoretical analysis. The sizing factors on the Simplified Form were developed as a simple site planning tool for small projects and to accelerate permit review and approval. Generalized assumptions were used and are documented in the Simplified Sizing requirements in [Section 2.2](#). Facilities sized through this approach assume that there is an overflow to an approved discharge point. Facilities built to the standards of Simplified Sizing are assumed to meet pollution reduction and flow control requirements but not infiltration and discharge requirements. Applicants have the option to use the sizing factors provided on the Simplified Approach Form or to follow the Presumptive or Performance Approach and submit an alternative facility size, along with supporting engineering or PAC calculations for BES review and consideration.

Table A-6. Simplified Sizing Spreadsheet Column Descriptions

Column	Description
Column (1)	Time in Minutes
Column (2)	Inflow (cfs) Note: Contributing Impervious area = 1 acre Note: 10-year storm event (3.4"/24 hours)
Column (3)	Inflow volume (cf) = Inflow (cfs) x 60 (sec/min) x 10 (min)
Column (4)	Cumulative Volume (cf) = Inflow volume (cf) + Inflow of previous step (cf)
Column (5)	Infiltration (cfs) = If(Inflow < Max infiltration, Inflow, Maximum Infiltration)
Column (6)	Maximum Infiltration (cfs) = Infiltration area (sf) x Infiltration rate (ft/s) Note: Infiltration rate is assumed to be 2.00"/hr
Column (7)	Incremental Storage (cf) = [Inflow(cfs) – Infiltration (cfs)] x 60 (sec/min) x 10 (min)
Column (8)	Cumulative Storage (cf)
Column (9)	Percentage Storage Capacity = Cumulative Storage/Facility Storage x 100 Planter Facility Storage = Facility Bottom Area (sf) x Storage Depth (ft) Note: Bottom Area = 2,825 Note: Storage Depth = 1 ft Storage capacity does not exceed 100% and the maximum depth of 12 inches is not exceeded. Facility sizing does not result in an overflow condition. Planter sizing divided by impervious area equals a 0.065 sizing factor.

Table A-7. Simplified Sizing Spreadsheet

(1) Time (minutes)	(2) Inflow (cfs)	(3) Inflow Volume (cf)	(4) Cumulative Volume (cf)	(5) Infiltration (cfs)	(6) Max. Infiltration (cfs)	(7) Incremental Storage (cf)	(8) Cumulative Storage Volume (cf)	(9) % Storage Capacity (%)
0	0.0000	0.00	0.00	0.0000	0.1308	-78.47	0.00	0%
10	0.0000	0.00	0.00	0.0000	0.1308	-78.47	0.00	0%
20	0.0000	0.00	0.00	0.0000	0.1308	-78.47	0.00	0%
30	0.0000	0.00	0.00	0.0000	0.1308	-78.47	0.00	0%
40	0.0026	1.54	1.54	0.0026	0.1308	-76.93	0.00	0%
50	0.0097	5.80	7.34	0.0097	0.1308	-72.67	0.00	0%
60	0.0180	10.79	18.13	0.0180	0.1308	-67.68	0.00	0%
70	0.0249	14.97	33.10	0.0249	0.1308	-63.50	0.00	0%
80	0.0308	18.50	51.60	0.0308	0.1308	-59.97	0.00	0%
90	0.0359	21.52	73.12	0.0359	0.1308	-56.95	0.00	0%
100	0.0402	24.11	97.24	0.0402	0.1308	-54.36	0.00	0%
110	0.0499	29.94	127.17	0.0499	0.1308	-48.54	0.00	0%
120	0.0599	35.94	163.11	0.0599	0.1308	-42.53	0.00	0%
130	0.0642	38.51	201.62	0.0642	0.1308	-39.96	0.00	0%
140	0.0679	40.71	242.33	0.0679	0.1308	-37.76	0.00	0%
150	0.0710	42.61	284.95	0.0710	0.1308	-35.86	0.00	0%
160	0.0738	44.27	329.22	0.0738	0.1308	-34.20	0.00	0%
170	0.0841	50.43	379.65	0.0841	0.1308	-28.04	0.00	0%
180	0.0944	56.66	436.31	0.0944	0.1308	-21.81	0.00	0%
190	0.0971	58.24	494.55	0.0971	0.1308	-20.24	0.00	0%
200	0.0993	59.60	554.15	0.0993	0.1308	-18.87	0.00	0%
210	0.1013	60.80	614.95	0.1013	0.1308	-17.67	0.00	0%
220	0.1031	61.85	676.81	0.1031	0.1308	-16.62	0.00	0%
230	0.1135	68.10	744.90	0.1135	0.1308	-10.38	0.00	0%
240	0.1239	74.37	819.27	0.1239	0.1308	-4.11	0.00	0%
250	0.1256	75.35	894.62	0.1256	0.1308	-3.12	0.00	0%
260	0.1270	76.22	970.83	0.1270	0.1308	-2.26	0.00	0%
270	0.1283	76.99	1047.82	0.1283	0.1308	-1.49	0.00	0%
280	0.1294	77.67	1125.49	0.1294	0.1308	-0.80	0.00	0%
290	0.1417	85.04	1210.53	0.1308	0.1308	6.57	6.57	0%
300	0.1541	92.45	1302.98	0.1308	0.1308	13.98	20.55	1%
310	0.1552	93.11	1396.09	0.1308	0.1308	14.64	35.19	1%
320	0.1562	93.70	1489.79	0.1308	0.1308	15.23	50.42	2%
330	0.1571	94.23	1584.03	0.1308	0.1308	15.76	66.18	2%
340	0.1578	94.71	1678.73	0.1308	0.1308	16.23	82.41	3%
350	0.1712	102.71	1781.44	0.1308	0.1308	24.24	106.65	4%
360	0.1845	110.73	1892.17	0.1308	0.1308	32.26	138.90	5%
370	0.1853	111.19	2003.36	0.1308	0.1308	32.72	171.62	6%
380	0.1860	111.60	2114.96	0.1308	0.1308	33.13	204.75	7%
390	0.1866	111.98	2226.94	0.1308	0.1308	33.50	238.26	8%
400	0.1872	112.31	2339.25	0.1308	0.1308	33.84	272.10	10%
410	0.2263	135.80	2475.06	0.1308	0.1308	57.33	329.43	12%
420	0.2657	159.39	2634.45	0.1308	0.1308	80.92	410.35	15%
430	0.2664	159.87	2794.32	0.1308	0.1308	81.40	491.75	17%
440	0.3131	187.88	2982.20	0.1308	0.1308	109.41	601.16	21%
450	0.3600	215.98	3198.18	0.1308	0.1308	137.51	738.66	26%
460	0.5219	313.11	3511.29	0.1308	0.1308	234.64	973.31	34%
470	0.8866	531.96	4043.26	0.1308	0.1308	453.49	1426.80	51%
480	0.8183	491.00	4534.26	0.1308	0.1308	412.53	1839.32	65%

Table A-7, continued

(1) Time (minutes)	(2) Inflow (cfs)	(3) Inflow Volume (cf)	(4) Cumulative Volume (cf)	(5) Infiltration (cfs)	(6) Max. Infiltration (cfs)	(7) Incremental Storage (cf)	(8) Cumulative Storage Volume (cf)	(9) % Storage Capacity (%)
490	0.4558	273.50	4807.76	0.1308	0.1308	195.03	2034.35	72%
500	0.3185	191.07	4998.83	0.1308	0.1308	112.60	2146.95	76%
510	0.2720	163.22	5162.05	0.1308	0.1308	84.75	2231.70	79%
520	0.2722	163.32	5325.38	0.1308	0.1308	84.85	2316.55	82%
530	0.2256	135.36	5460.73	0.1308	0.1308	56.89	2373.44	84%
540	0.1789	107.36	5568.10	0.1308	0.1308	28.89	2402.33	85%
550	0.1790	107.40	5675.50	0.1308	0.1308	28.93	2431.26	86%
560	0.1791	107.44	5782.94	0.1308	0.1308	28.97	2460.23	87%
570	0.1791	107.47	5890.41	0.1308	0.1308	29.00	2489.23	88%
580	0.1792	107.51	5997.92	0.1308	0.1308	29.03	2518.26	89%
590	0.1792	107.54	6105.46	0.1308	0.1308	29.07	2547.33	90%
600	0.1793	107.57	6213.02	0.1308	0.1308	29.10	2576.42	91%
610	0.1793	107.60	6320.62	0.1308	0.1308	29.13	2605.55	92%
620	0.1794	107.63	6428.25	0.1308	0.1308	29.15	2634.70	93%
630	0.1794	107.65	6535.90	0.1308	0.1308	29.18	2663.88	94%
640	0.1795	107.68	6643.58	0.1308	0.1308	29.21	2693.09	95%
650	0.1632	97.91	6741.49	0.1308	0.1308	19.44	2712.53	96%
660	0.1469	88.14	6829.63	0.1308	0.1308	9.66	2722.19	96%
670	0.1469	88.15	6917.78	0.1308	0.1308	9.68	2731.87	97%
680	0.1469	88.17	7005.95	0.1308	0.1308	9.70	2741.57	97%
690	0.1470	88.18	7094.13	0.1308	0.1308	9.71	2751.28	97%
700	0.1470	88.20	7182.33	0.1308	0.1308	9.72	2761.00	98%
710	0.1470	88.21	7270.54	0.1308	0.1308	9.74	2770.74	98%
720	0.1470	88.22	7358.76	0.1308	0.1308	9.75	2780.49	98%
730	0.1471	88.24	7446.99	0.1308	0.1308	9.76	2790.26	99%
740	0.1471	88.25	7535.24	0.1308	0.1308	9.78	2800.03	99%
750	0.1471	88.26	7623.50	0.1308	0.1308	9.79	2809.82	99%
760	0.1471	88.27	7711.77	0.1308	0.1308	9.80	2819.62	100%
770	0.1318	79.09	7790.86	0.1308	0.1308	0.61	2820.23	100%
780	0.1165	69.90	7860.76	0.1165	0.1308	-8.57	2811.66	100%
790	0.1165	69.90	7930.66	0.1165	0.1308	-8.57	2803.09	99%
800	0.1165	69.91	8000.57	0.1165	0.1308	-8.56	2794.53	99%
810	0.1165	69.92	8070.49	0.1165	0.1308	-8.55	2785.98	99%
820	0.1165	69.92	8140.42	0.1165	0.1308	-8.55	2777.43	98%
830	0.1166	69.93	8210.35	0.1166	0.1308	-8.54	2768.89	98%
840	0.1166	69.94	8280.28	0.1166	0.1308	-8.54	2760.35	98%
850	0.1166	69.94	8350.23	0.1166	0.1308	-8.53	2751.82	97%
860	0.1166	69.95	8420.17	0.1166	0.1308	-8.52	2743.30	97%
870	0.1166	69.95	8490.13	0.1166	0.1308	-8.52	2734.78	97%
880	0.1166	69.96	8560.09	0.1166	0.1308	-8.51	2726.27	97%
890	0.1094	65.67	8625.76	0.1094	0.1308	-12.80	2713.46	96%
900	0.1023	61.38	8687.13	0.1023	0.1308	-17.10	2696.37	95%
910	0.1023	61.38	8748.51	0.1023	0.1308	-17.09	2679.28	95%
920	0.1023	61.38	8809.90	0.1023	0.1308	-17.09	2662.19	94%
930	0.1023	61.39	8871.29	0.1023	0.1308	-17.08	2645.10	94%
940	0.1023	61.39	8932.68	0.1023	0.1308	-17.08	2628.03	93%
950	0.1023	61.40	8994.08	0.1023	0.1308	-17.08	2610.95	92%
960	0.1023	61.40	9055.48	0.1023	0.1308	-17.07	2593.88	92%
970	0.1023	61.40	9116.88	0.1023	0.1308	-17.07	2576.81	91%

Table A-7, continued

(1) Time (minutes)	(2) Inflow (cfs)	(3) Inflow Volume (cf)	(4) Cumulative Volume (cf)	(5) Infiltration (cfs)	(6) Max. Infiltration (cfs)	(7) Incremental Storage (cf)	(8) Cumulative Storage Volume (cf)	(9) % Storage Capacity (%)
980	0.1023	61.41	9178.29	0.1023	0.1308	-17.06	2559.74	91%
990	0.1024	61.41	9239.70	0.1024	0.1308	-17.06	2542.68	90%
1000	0.1024	61.41	9301.11	0.1024	0.1308	-17.06	2525.62	89%
1010	0.0921	55.28	9356.39	0.0921	0.1308	-23.20	2502.43	89%
1020	0.0819	49.14	9405.53	0.0819	0.1308	-29.34	2473.09	88%
1030	0.0819	49.14	9454.66	0.0819	0.1308	-29.33	2443.76	87%
1040	0.0819	49.14	9503.80	0.0819	0.1308	-29.33	2414.43	85%
1050	0.0819	49.14	9552.95	0.0819	0.1308	-29.33	2385.10	84%
1060	0.0819	49.14	9602.09	0.0819	0.1308	-29.33	2355.77	83%
1070	0.0819	49.15	9651.24	0.0819	0.1308	-29.33	2326.44	82%
1080	0.0819	49.15	9700.39	0.0819	0.1308	-29.32	2297.12	81%
1090	0.0819	49.15	9749.54	0.0819	0.1308	-29.32	2267.80	80%
1100	0.0819	49.15	9798.69	0.0819	0.1308	-29.32	2238.48	79%
1110	0.0819	49.15	9847.84	0.0819	0.1308	-29.32	2209.16	78%
1120	0.0819	49.16	9897.00	0.0819	0.1308	-29.32	2179.84	77%
1130	0.0819	49.16	9946.16	0.0819	0.1308	-29.31	2150.53	76%
1140	0.0819	49.16	9995.32	0.0819	0.1308	-29.31	2121.22	75%
1150	0.0819	49.16	10044.48	0.0819	0.1308	-29.31	2091.91	74%
1160	0.0819	49.16	10093.64	0.0819	0.1308	-29.31	2062.60	73%
1170	0.0819	49.16	10142.81	0.0819	0.1308	-29.31	2033.29	72%
1180	0.0819	49.17	10191.97	0.0819	0.1308	-29.31	2003.98	71%
1190	0.0819	49.17	10241.14	0.0819	0.1308	-29.30	1974.68	70%
1200	0.0820	49.17	10290.31	0.0820	0.1308	-29.30	1945.38	69%
1210	0.0820	49.17	10339.48	0.0820	0.1308	-29.30	1916.08	68%
1220	0.0820	49.17	10388.66	0.0820	0.1308	-29.30	1886.78	67%
1230	0.0820	49.18	10437.83	0.0820	0.1308	-29.30	1857.48	66%
1240	0.0820	49.18	10487.01	0.0820	0.1308	-29.30	1828.19	65%
1250	0.0820	49.18	10536.19	0.0820	0.1308	-29.29	1798.89	64%
1260	0.0820	49.18	10585.37	0.0820	0.1308	-29.29	1769.60	63%
1270	0.0820	49.18	10634.55	0.0820	0.1308	-29.29	1740.31	62%
1280	0.0820	49.18	10683.73	0.0820	0.1308	-29.29	1711.02	61%
1290	0.0820	49.18	10732.91	0.0820	0.1308	-29.29	1681.73	60%
1300	0.0820	49.19	10782.10	0.0820	0.1308	-29.29	1652.44	58%
1310	0.0820	49.19	10831.29	0.0820	0.1308	-29.28	1623.16	57%
1320	0.0820	49.19	10880.48	0.0820	0.1308	-29.28	1593.88	56%
1330	0.0820	49.19	10929.67	0.0820	0.1308	-29.28	1564.59	55%
1340	0.0820	49.19	10978.86	0.0820	0.1308	-29.28	1535.31	54%
1350	0.0820	49.19	11028.05	0.0820	0.1308	-29.28	1506.03	53%
1360	0.0820	49.19	11077.24	0.0820	0.1308	-29.28	1476.76	52%
1370	0.0820	49.20	11126.44	0.0820	0.1308	-29.28	1447.48	51%
1380	0.0820	49.20	11175.64	0.0820	0.1308	-29.28	1418.20	50%
1390	0.0820	49.20	11224.84	0.0820	0.1308	-29.27	1388.93	49%
1400	0.0820	49.20	11274.04	0.0820	0.1308	-29.27	1359.66	48%
1410	0.0820	49.20	11323.24	0.0820	0.1308	-29.27	1330.39	47%
1420	0.0820	49.20	11372.44	0.0820	0.1308	-29.27	1301.12	46%
1430	0.0820	49.20	11421.64	0.0820	0.1308	-29.27	1271.85	45%
1440	0.0820	49.20	11470.85	0.0820	0.1308	-29.27	1242.58	44%
1450	0.0410	24.60	11495.45	0.0410	0.1308	-53.87	1188.71	42%

A.3 Stormwater Pollution Reduction Storm

POLLUTION REDUCTION STORM

This methodology was originally developed in 2004. References and analysis has not been updated.

The development of design storms for the sizing of stormwater pollution reduction (treatment) facilities generally involves a statistical analysis of local rainfall data, whereas a certain storm volume, duration, and peak intensity (or rainfall distribution) is identified to achieve a predetermined treatment volume goal. This treatment volume goal will vary from jurisdiction to jurisdiction, but is generally 80 to 95% of the average annual runoff (Table A-8). It can be linked to a jurisdiction's municipal stormwater discharge permit (MS4 permit) definition of MEP (maximum extent practicable) as it relates to the removal of pollutants from stormwater.

TREATMENT VOLUME GOAL

Portland has used a single treatment storm methodology (0.83 inches over 24 hours; NRCS Type 1A rainfall distribution) since 1994. The original intent of this design storm was to: 1) treat the “first-flush” or first 0.5 inches of runoff from all storm events and 2) pass 100% of 95% of all storm events through the treatment facility.

The City of Eugene uses a treatment goal of 80% of the average annual runoff; Gresham also uses 80% of the average annual runoff. The Washington State Department of Ecology (and thus many other jurisdictions in Washington) uses 91%.

A continuous simulation analysis, summarized as Figure A-4, was performed on multiple years of rainfall data to determine the percentage of average annual rainfall that should be treated to maximize treatment efficiency. This analysis indicates a knee in the curve somewhere between 80 and 85 percent of the average annual volume. It may not be desirable to set the treatment goal directly at the economically optimal point, as stormwater treatment facilities do not always operate at their optimal design flow rates. A margin of safety should be incorporated into the treatment volume goal. For these reasons, the City of Portland has chosen to set its treatment volume goal at 90% of the average annual rainfall volume.

RATE BASED TREATMENT SYSTEMS

Stormwater treatment systems can be divided into two categories based on the methods used to size them: rate (or flow) and volume (or detention) based systems. Rate based systems remove pollutants with physical processes that settle or filter particulates as the flow passes through the system. The actual volume of the facility doesn't play a major role in the pollutant removal process, as there isn't a significant detention period for the water to remain in the system for any length of time.

A continuous simulation model can easily be used to determine the average annual runoff volume percentage treated by a rate based system (Figure A-2). An assumption is that 100% of the runoff less than or equal to the peak treatment flow rate is fully treated, while the flows that exceed the peak treatment flow rate receive no treatment. Different assumptions can be made for on and off-line treatment systems. Likewise, an analysis of continuous rainfall intensity data can determine the average annual rainfall volume that is associated with a particular range of rainfall intensities. This type of analysis was completed for four different rain gages representing the different quadrants of Portland, and is summarized in Table A-9. Pollution Reduction Storm Analysis (2004). Five, ten and 20-minute intensities were analyzed to determine the intensities associated with the 90% rainfall volume goal. For 5-minute intensities, rainfall intensities of 0.19 inches per hour or less were determined to account for 90% of the average annual rainfall volume.

Eugene performed an analysis on 50 years of Eugene Airport rainfall data and also concluded that a rainfall intensity of 0.19"/hr would be needed to treat 90% of the average annual runoff volume.

Figure A-2. Continuous simulation determination of 90% treatment flow rate

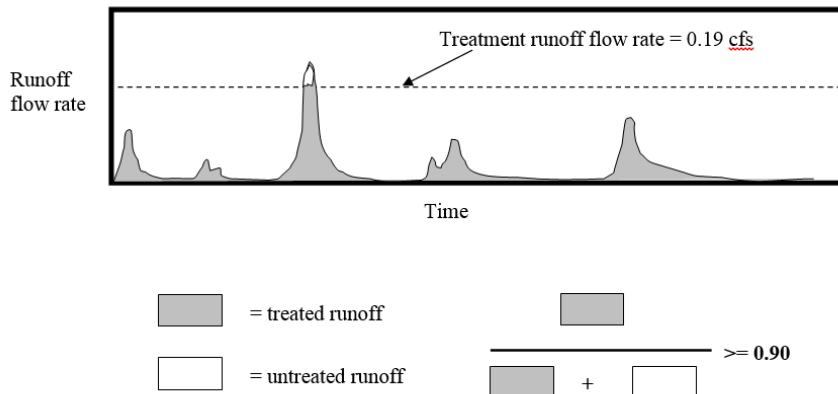

VOLUME BASED TREATMENT SYSTEMS

Unlike rate based systems, volume (or detention) based systems provide a significant storage volume for water to accumulate and be detained for a period of time. Pollutants are removed through physical (settlement) and/or biological processes. Unlike rate based systems, it is not easy to model volume based systems with continuous simulation models or rainfall analysis. Storm detention time needs to be factored into the model, and the mixing of water within the facility from one storm to the next creates a complex process that cannot be simulated accurately at this time. The currently accepted methodology used to size volume based treatment facilities is to set the wet portion of the pond or wetland (permanent pool) equal to the full volume of runoff generated by the predetermined water quality storm, and apply a safety factor (V_b/V_r ratio) (Figure A-3).

The volumes of most jurisdictions' water quality storms are set at their average annual treatment volume goal. For example, if the goal is to treat 80% of the average annual flow volume, the treatment storm depth is set to the 80% percentile storm. Eugene's goal is to treat 80% of the average annual volume. Their water quality storm is 1.4"/24 hours, which is equal to the 80th percentile storm. 80% of their storm events have a depth of 1.4 inches or less. In Portland's case, the 0.83" storm is not equal to the 90th percentile storm. An estimate would put it somewhere between the 60th and 65th percentile storm. This had been compensated for in the September 2002 Stormwater Management Manual by requiring volume-based facilities to use twice the volume of runoff generated by the 0.83" storm, or a V_b/V_r ratio of 2, but this factor should most likely be a function of soil type. In a recent version of Stormwater Treatment Northwest (Vol 9, No 4), Gary Minton and Roger Sutherland suggest that Pacific Northwest monitoring data indicates that a V_b/V_r ration of 1 may be adequate to achieve a TSS removal of 80%.

The City of Eugene has performed an analysis on 50 years of Eugene Airport rainfall data, and concluded that 90% of rainfall events are less than 2.4 inches in depth. Hourly rainfall intensity data was used in the analysis, storm depths of 0.01 inches or less were eliminated from the analysis, and a minimum inter-event time of 6 hours was used. A slight change in the modeling assumptions has a significant impact on the outcome. In the December 2003 issue of Stormwater Treatment Northwest, Gary Minton stated that an analysis he did of 24-hour rainfall data from the Seattle-Tacoma International Airport indicated that with a storm depth of about 1.35 inches, 90% of the runoff would be treated over time. The specific assumptions that were used in Dr. Minton's analysis are not known, but he was not using the 90th percentile Seattle-Tacoma storm. The Washington State Department of Ecology's

Western Washington Stormwater Manual targets the capture of 91% of the average annual runoff for water quality, which they equate to two-thirds of a 2-year storm event (roughly 1.65 inches). Again, this storm event is not equivalent to the 91st percentile Western Washington storm.

A way of modeling the rainfall that could result in a clearer link to the treatment goal may be to determine the volume of a wet basin that will result in an average storm detention time of 24, 36, or 48 hours, depending on the anticipated TSS settling velocity in the vicinity of the site. The assumed inter-event time could be adjusted to ensure that enough detention time is provided between each storm event. An assumption could be made that storms with total volumes less than the “90% treatment storm” would receive 100% treatment. Storms with total volumes greater than the “90% treatment storm” would receive partial treatment: 100% treatment for the volume equal to the 90% storm volume, and 0% treatment for the volume greater than the 90% storm volume. This may be overly conservative, as some very long, drawn-out storms (>24 hours) with total volumes greater than the designated treatment volume, may in fact receive greater than 24 hours of detention time for the entire storm, or 100% effective treatment.

Figure A-3. Continuous Simulation Determination of 90% Treatment Volume

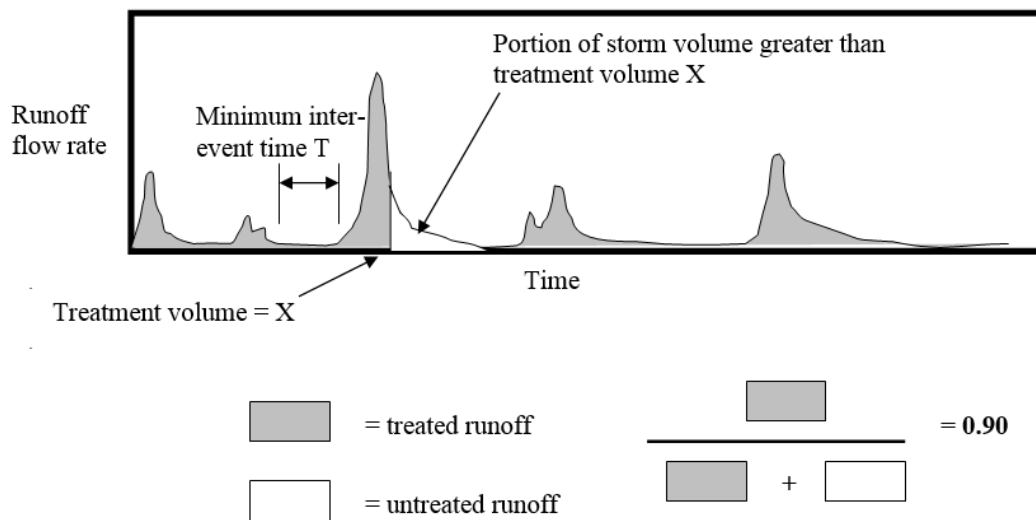

CONCLUSION

The Portland water quality design storm shall be stated as a volume treatment goal- e.g. “90% of the average annual runoff shall be treated”, and will be clarified by stating the peak rainfall intensity, and total volume components. This achieves two things:

- Volume based facilities and rate based facilities will be theoretically sized to achieve treatment of the same percentage of average annual runoff volume.
- With the treatment rainfall intensity already given, the SBUH or other hydrograph based hydrologic analysis method won't be needed to size rate based treatment facilities, simplifying the design process. Rather, the Rational Method can be used to calculate the runoff treatment flow rate, based on the site's time of concentration.

To achieve the treatment of 90% of the average annual rainfall volume, rate based facilities must be sized to treat rainfall at 0.19 inches per hour for sites with 5-minute time of concentration or less, 0.16 inches per hour for sites with a 10-minute time of concentration, and 0.13 inches per hour for sites with a 20-minute time of concentration.

For volume based facilities, Portland shall continue to size wet basins using 0.83 inches of rainfall over 24 hours (NRCS Type 1A rainfall distribution), with a V_b/V_r ratio of 2.

Table A-8. Comparison of Pacific Northwest Water Quality Design Storms (2004)

Jurisdiction	Average Annual Runoff (in)	Treatment Goal (average annual runoff %)	Water Quality Storm Volume (in)	Volume Based Facility Sizing Factors	WQ Storm Duration (hrs)	WQ Storm Intensity for off-line facilities (in/hr)	WQ storm intensity for on-line facilities (in/hr)
Gresham	37.4	80	1.2	1	12	0.11	0.20
Eugene	46.6	80	1.4	1	24	0.13	0.22
Corvallis	43.2	90	0.90, 0.3 mean ann. for wet ponds	3	24	Not Specified: 0.90" storm peak 10 min intensity (per NRCS 1A distribution) = 0.29 in/hr	
Clean Water Services	36	85	0.36	1	4	WQ Volume / 4 hours = 0.09 in/hr	
Department of Environmental Quality (OR)	varies 37 avg.		2-year storm: 2.4"	1	24	Not Specified: 2.4" storm peak 10 min Intensity (per NRCS 1A distribution) = 0.78 in/hr	
Tacoma, WA	37.6	91	6-mo storm volume	1	24	91% treatment, HSPF continuous simulation, different on & off-line	
Seattle, WA	38.6		Mean annual storm = 0.47	1	24	6-month storm (64% of 2-year storm or 1.08 inches) peak 10-min intensity using SBUH = 0.35 in/hr	
King County (WA)	38.6	95	Mean annual storm = 0.47-0.65	3	24	60% of 2-yr storm flow rate using KCRTS continuous simulation, or 64% of 2-yr storm flow rate using SBUH	

Table A-8, continued

Jurisdiction	Average Annual Runoff (in)	Treatment Goal (average annual runoff %)	Water Quality Storm Volume (in)	Volume Based Facility Sizing Factors	WQ Storm Duration (hrs)	WQ Storm Intensity for off-line facilities (in/hr)	WQ storm intensity for on-line facilities (in/hr)
Department of Ecology (WA) (Western WA)	varies 36-46	91	6-month storm volume: Varies	1	24	91% treatment: varies by jurisdiction, HSPF continuous simulation, different on & off-line	
Portland	36	90	90% ave. annual treatm't volume*	1 if $V_r = 1.7$ 2 if $V_r = .83$	24	90% treatment as shown by continuous simulation (see Table A-9) = 0.19 to 0.13 in/hr, depending on site's ToFC	

*As defined by the recommended analysis of 24 years of Portland rainfall data, assuming a minimum inter-event time of 12 hours and minimum rainfall amount of 0.01 inches (see Table A-10Table A-10. Volumes Resulting in Treatment of 90% of Rainfall Volume (2004)). Portion of storm volume below specified treatment volume receives 100% treatment, portion of storm volume above specified treatment volume receives 0% treatment.

Figure A-4. Rainfall Intensity vs. Percentage of Annual Rainfall Volume (2004)

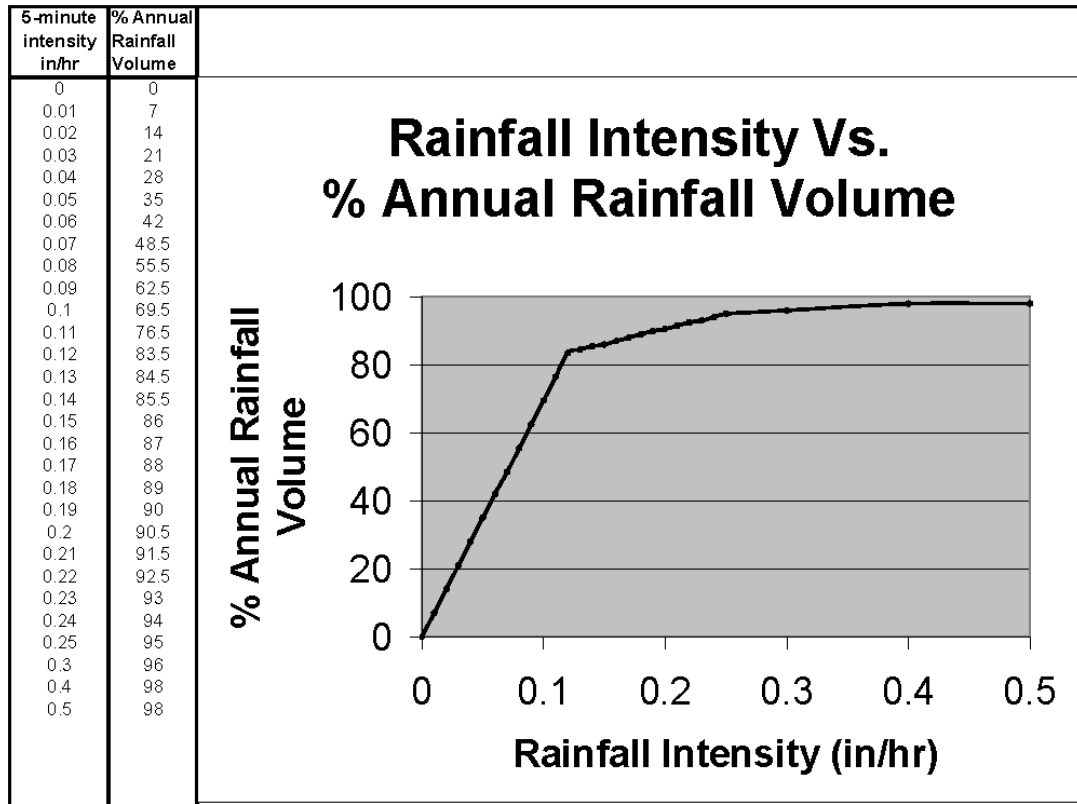

Rainfall data taken from each of the four Portland quadrants, then averaged.

Table A-9. Pollution Reduction Storm Analysis (2004)

Intensity by Quadrant	Rainfall Depth (in)	Average
5 min (NW)	0.19	0.19 in/hr
5 min (SW)	0.19	
5 min (SE)	0.20	
5 min (NE)	0.19	
10 min (NW)	0.15	0.16 in/hr
10 min (SW)	0.15	
10 min (SE)	0.165	
10 min (NE)	0.16	
20 min (NW)	0.13	0.13 in/hr
20 min (SW)	0.12	
20 min (SE)	0.14	
20 min (NE)	0.135	

Assumption: Percentage of rainfall less intense than specified intensity receives 100% treatment, percentage of rainfall more intense than specified intensity receives 0 treatment.

Table A-10. Volumes Resulting in Treatment of 90% of Rainfall Volume (2004)

Place and Time	Total Rainfall (in)	Number of 12-hr storms	Average storm size (in)	90% Treatment Storm Size (in)	Average 90% Treatment Storm Size (in)
NW 97-98	80.15	169	0.47	1.6	1.7
NW 90-91	65.5	163	0.40	1.3	
NW 83-84	83.9	202	0.42	1.9	
NW 80-81	95.37	247	0.39	2.1	
SW 97-98	73.85	176	0.42	1.4	1.7
SW 90-91	61.83	180	0.34	1.25	
SW 83-84	82.37	201	0.41	1.9	
SW 80-81	67.45	160	0.42	2.1	
SE 97-98	74.41	185	0.40	1.6	1.8
SE 90-91	63.71	184	0.35	1.3	
SE 83-84	82.75	192	0.43	2.0	
SE 80-81	65.41	163	0.40	2.3	
NE 97-98	74.00	180	0.41	1.4	1.7
NE 90-91	64.62	176	0.37	1.2	
NE 83-84	72.27	217	0.33	1.7	
NE 80-81	65.37	188	0.35	2.3	

Assumptions: Percentage of storm volume less than specified volume receives 100% treatment, percentage of storm volume greater than specified volume receives 0 treatment. Storm event is defined by a minimum of 0.01 inches of rainfall with a minimum inter-event period of 12 hours.

A.4 Presumptive Approach Calculator Technical Framework

The Presumptive Approach Calculator (PAC) was developed to provide design professionals a standard tool for sizing vegetated stormwater facilities in accordance with the Stormwater Infiltration and Discharge Hierarchy ([Section 1.3](#)) and the Presumptive Sizing Approach ([Section 2.2.2](#)) of the Stormwater Management Manual (SWMM). The capability of the PAC includes sizing of stormwater facilities based on native soil infiltration rates, a standard growing medium infiltration rate, and above and below grade storage volumes.

The PAC allows a designer to use the native soil infiltration rates and test different vegetated stormwater facility configurations to find a design that meets the appropriate Stormwater Hierarchy goals for the site. Design parameters that influence results are the three facility types (swale, planter and basin), longitudinal slopes for swales, three facility shapes (rectangle, amoeba, or user defined), surface area, above ground capacity, below ground capacity, side slopes, depth to overflow and native infiltration rates.

The following are example scenarios that a design engineer can achieve and optimize using the PAC:

- Size surface infiltration facilities with or without an underground rock storage layer.
- Quickly evaluate various alternatives for facilities of different shapes, sizes and depths.
- Balance the facility size with underground rock storage layer depth and footprint area when sizing a facility to minimize the extent of excavation and placement of rock.
- Size facilities with Configuration E or F under Stormwater Hierarchy Category 2 as a self-contained UIC, providing a minimum sizing to support surface infiltration of the Pollution Reduction storm event, but allowing larger flows to bypass the growing medium and utilize additional below grade storage and/or access higher infiltration rates through the native soils.
- Size facilities to meet flow control requirements for Stormwater Hierarchy Categories 3 or 4.
- Overflow of runoff data discharging from a surface stormwater facility for 2, 5, 10 and 25-year storm events can be exported for further analysis to meet flow control requirements.

Although the sizing methodology has been standardized for the PAC, professional judgment is still required when evaluating the results and verifying the performance of a particular stormwater facility. A model run may achieve a successful design result for the requirements of the chosen Stormwater Hierarchy, but have to contend with site design challenges and constraints in addition to all other relevant code, project or development proposal requirements. If a project designer proposes to deviate from the recommended ranges, the City may require that the project to be designed under the Performance Approach.

The PAC is not intended to:

- Size multiple facilities at once or in sequence. A separate calculation is required for each paired facility and catchment.
- Calculate conveyance or analyze discharge point or emergency overflow pathway.
- Size drywells or other underground injection devices.
- Serve as an Operations and Maintenance Plan.
- Size detention ponds for flow control requirements.

Overview of the PAC

This technical framework provides an overview of the calculations used in the PAC. It assumes general knowledge of Stormwater Management Manual requirements, including the Stormwater Hierarchy. The PAC uses standard terminology common to sizing of stormwater facilities throughout, but if there are any questions, refer to [Glossary](#) for definitions of terms used throughout the PAC. Additionally, the PAC was developed as a standard sizing tool, which required developing an optimal set of ranges for input variables. Refer to [Allowed and Recommended Ranges](#) for design data criteria and supplemental information on error or warning messages. Values outside the recommended range do not prevent the PAC from running the calculations, but additional documentation may be required with the submittal and design or review of the facility may fall under the Performance Approach. The PAC will not function using values outside of the allowable range.

Project designers begin a PAC project by entering in basic project information, such as address and contact information. For each catchment, the designer will need to enter impervious area and native soil infiltration testing results and then select the appropriate stormwater hierarchy category. The PAC will develop a SBUH hydrograph that will serve as the stormwater facility input hydrograph. The designer

will then enter stormwater facility information for each catchment. Any number of catchments, each with a single stormwater facility, can be added to a project. Design data can be modified until it meets the desired project goals as required by the selected stormwater hierarchy category. The PAC will calculate results based on selected Stormwater Hierarchy Category and will indicate whether the facility achieves a “pass” or “fail” for the modeled storm events to meet pollution reduction and flow control requirements for the selected stormwater hierarchy.

At the completion of design, a PAC generates a PDF report that summarizes the project, catchment, and facility information. The PAC report will include relevant Pollution Reduction Sizing, 10-year storm sizing, and peak output for 2, 5, 10 and 25-year design storms. In addition, the report will include the sizing ratio, the overflow volume and the percentage of surface and rock storage capacity for each facility.

The following sections describe the qualitative and quantitative options that will influence stormwater facility sizing.

Stormwater Infiltration and Discharge Hierarchy

The selection of the intended Stormwater Hierarchy Category (1 through 4) will determine the required results of the PAC (Figure A-5). If the PAC results do not meet the requirements, the project designer will need to adjust the catchment or facility design in an iterative process until the required results are met.

Only the two Facility Configurations A & B are eligible to meet the requirements of Stormwater Hierarchy Category 1. All Facility Configurations A through F are available for Hierarchy Category 2. Facility Configurations A through D are available for Hierarchy Category 3 and 4.

A-5. Stormwater Management Requirements by Stormwater Hierarchy Category

Hierarchy Category	SWMM Requirement	Meets Pollution Reduction Requirements	Flow Control Requirement
1	Onsite infiltration with a surface infiltration facility	Yes	Infiltration the 10-year design storm
2	Onsite infiltration with a surface infiltration facility with overflow to an approved UIC facility	Yes	Infiltration the 10-year design storm or use UIC
3.a	Off-site flow to Willamette River, Columbia River, or Columbia Slough, or discharge to a storm-only piping system or Multnomah County Drainage District system (with capacity) that directly discharges to one of the above water bodies	Yes	None
3.b	Discharge to overland storm drainage system, including streams, drainageways, ditches or other storm pipe system that discharges to an overland drainage system	Yes	Limit 2-year post-development peak flow rates to one-half of the 2-year pre-development peak rate and maintain post-development peak flow rates at the pre-development levels for the 5-, 10-, and 25-year events.
3.c	Base requirement for all other discharge points	Yes	Maintain peak flow rates at the predevelopment levels for the 2-, 5-, and 10-year, 24-hour runoff events
4	Discharge to a combined sewer	Yes	Limit 25-year post-development peak runoff rate to 10-year predevelopment peak rate

Stormwater Facility Shapes

The PAC offers three facility shapes to for Basin facility types, each with a different calculation to estimate the storage capacity. The different shapes allow flexibility in sizing to calculate storage volumes.

The Rectangle/Square facility shape is aptly named and can be simply defined. The proposed bottom area, the side slopes and depth are used to calculate available volume.

The Amoeba calculates volumes for organically shaped facilities with both convex and concave curves and uses the perimeter length around the proposed bottom area, the side slope and depth to calculate available volume. If the proposed facility will be more oval or round shaped with minimal or no concave curves, then the calculation would underestimate the storage volume and the User Defined shape may provide a more accurate calculation.

The User Defined shape can calculate available storage for any shape using the average end area method to calculate volumes. The designer needs to lay out the facility on paper or CAD when taking surface area measurements to consider side slopes between the bottom and top surface areas.

To simplify the sizing iterations, a designer may use the Rectangle/Square Facility shape to roughly size the facility and then select a different shape to fine tune the design and more accurately represent the proposed condition. Using the Amoeba or User Defined shape requires new perimeter length and area measurements for each iteration that can be time consuming for preliminary sizing.

Stormwater Facility Configurations

The PAC allows for up to six different facility configurations. The following is a brief overview of the different configurations and applicability.

Stormwater Facility Configurations A and B

These facilities are the only two that can satisfy the requirements of Stormwater Hierarchy Category 1. These facilities use two-stage calculations to model the configuration. These facilities can also be selected for any other Stormwater Hierarchy Category. These facilities are sized so that at a minimum, the Pollution Reduction event infiltrates through the growing medium, but to meet Stormwater Hierarchy Category 1, the facility must be sized to infiltrate the 10-yr storm without overflowing. Where the surface storage is exceeded, overflow is to the approved discharge. Configurations A and B are limited by the surface infiltration capacity through the growing medium even if there are higher infiltration rates through the native soils.

Configuration A: Infiltration

- No rock storage provided below grade. This configuration is best applied when the design infiltration rate for the native soil is greater than the design infiltration rate for the growing medium of 2 inches per hour.
- If the below grade infiltration capacity is less than the above grade infiltration capacity, the PAC uses the lower native soil infiltration capacity for the Stage I calculations.

Configuration B: Infiltration with rock storage

- Rock storage is provided below grade. This configuration is best applied when the design infiltration rate for the native soil is less than the design infiltration rate for the growing medium of 2 inches per hour.
- The rock storage provides additional contact area with the native soils than with configuration A and increases the potential for infiltration.

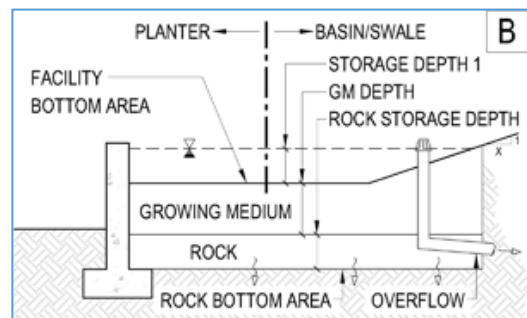
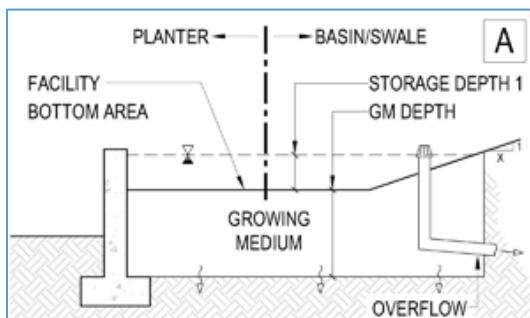

Stormwater Facility Configurations C and D

Under these two configurations, an assumption is made that no measurable runoff will infiltrate into the native subgrade. All the runoff that enters the facility is assumed to be discharged either as percolated runoff collected by the underdrain pipe or as overflow that is collected and conveyed to the same discharge pipe. This discharge through the underdrain pipe eliminates Stormwater Hierarchy Category 1 as a goal. Since it is assumed that there is no interface with the native subgrade, only the first stage of the two-stage calculation is required to model the configuration (see 3.4 for discussion of two-stage calculations). These facilities are sized so that at a minimum, the Pollution Reduction event infiltrates through the growing medium, but any larger storm events would overflow to the approved discharge.

Configuration C: Infiltration with rock storage and underdrain

- No impermeable liner is placed around the facility
- The facility may allow some minor infiltration, but the PAC calculations do not estimate this volume.

Configuration D: Lined facility with rock storage and underdrain

- An impermeable liner is placed around the facility

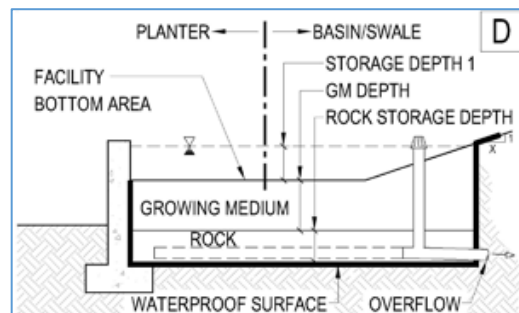
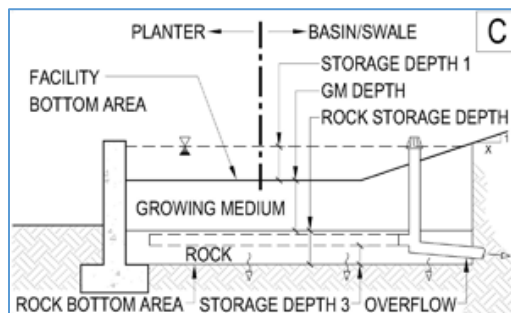

Stormwater Facility Configurations E and F

These are the only facilities that allow overflow stormwater to bypass the growing medium to the rock storage, which requires them to be registered as an Underground Injection Control (UIC), similar to a soakage trench, sump or drywell. These facilities are sized so that at a minimum the Pollution Reduction event infiltrates through the growing medium, but larger storm events are allowed to overflow to the rock storage layer below. This overflow eliminates Stormwater Hierarchy Category 1 as a goal. These configurations can be especially useful on sites where there is not space available for configurations A or B (generally larger than E or F) or on sites where the native infiltration rate is greater than that of the growing medium. Providing a direct connection to the below grade rock storage allows the facility to take advantage of the higher native infiltration capacity or provide additional below grade storage to reduce the size of the facility. Because E & F allow minimum sizing of the surface component based on the Pollution Reduction event like Configurations C & D and allow a portion of larger events to bypass the growing medium like a UIC, they are considered a “hybrid” configuration design.

Configuration E: Infiltration with bypass to rock storage

- Can allow greater surface storage above what is needed for the Pollution Reduction event.
- In the condition where the below grade infiltration capacity is less than the surface infiltration capacity, and the rock storage becomes full, the below grade restriction will limit the infiltration rate on the surface and cause the water on the surface to remain longer through and after a storm event.

Configuration F: Infiltration with underdrain and bypass to rock storage

- For projects where minimal surface depth is important, this configuration allows maximum sub-surface storage while ensuring that the surface storage drains freely based on the surface infiltration capacity of the facility.
- Contrary to Configuration E, any limitation of below grade infiltration relative to surface percolation or overflow flows will accumulate in the rock storage and discharge through the below grade outflow pipe without restricting infiltration of the water on the surface.

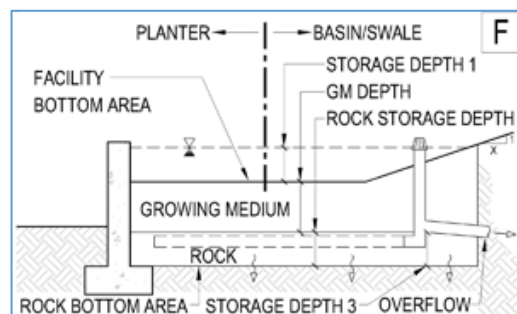
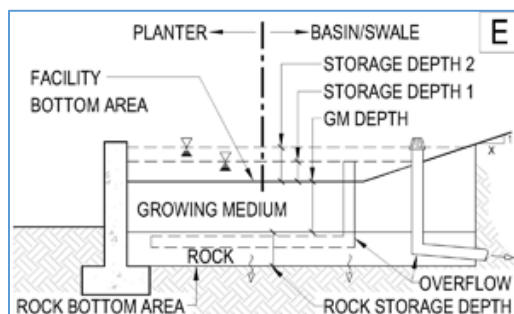

Interpreting the Results

There are up to four pieces of data generated for both the Pollution Reduction sizing and flow control results for each catchment/facility pairing. These are the “PASS” or “FAIL” text, the overflow volume, the maximum Percent Surface Capacity Used and the maximum Percent Rock Capacity Used. In general, the PAC generates a “PASS” if the above grade storage component does not overtop to the approved discharge. In contrast, the PAC generates a “FAIL” if the facility does overtop to the approved discharge during the respective storm event.

For a “FAIL” result, the overtopping volume can be compared to the total volume of the respective storm event shown on the SBUH hydrograph to gauge the extent of under-sizing of the facility. Knowing the percent or portion of above grade or below grade storage available during the Pollution Reduction or relevant storm event allows the project designer to refine the facility parameters and optimize the design without exceeding the capacity.

Stormwater Hierarchy Category Goals

When Stormwater Hierarchy Category 1 is selected, it is required that both facility must be able to infiltrate the Pollution Reduction storm sizing and infiltrate a 10-yr storm event to achieve a “PASS” result. However, if Stormwater Hierarchy Category 2 is selected, then it is only required that the facility is sized to infiltrate the Pollution Reduction storm to achieve a “PASS” result. The project designer then has the option of indicating that a separate UIC facility will be used downstream to infiltrate the 10-yr storm event. Supplemental documentation supporting the design of the UIC will be required.

When Hierarchy Category 3 or 4 is selected, the facility is required to achieve a “PASS” result for being sized to treat the Pollution Reduction storm. The facility must also be sized to meet the specific stormwater hierarchy category requirements for flow control. Flow control requirements are met based on modeling peak discharge rates generated for the appropriate 2, 5, 10 & 25-year storm events and comparing those peak runoff rates for the same catchment area under pre-existing conditions for modeled storm events.

Graphs and Tables

The PAC produces summary information and graphs to illustrate the performance of the facility throughout the duration of various storm events and up to 48 hours (2,880 minutes). The longer duration allows the graph to show the flows that lag past the 24-hour storm event as the water passes through the growing medium or infiltrates into the native soils. The tables that support the graphs can be viewed and exported.

The calculations can be performed without viewing the graphs or supporting tables, but the graphs can sometimes provide clues to the facility performance to more quickly determine an optimally sized design. For example, a line that is reverse-scaled from the top of the graph per a second axis on the right side of the graph indicates the amount of storage being used (% full) for the surface and rock storage as applicable. This “real-time” graphing of the storage capacity during a modeled storm event allows the project designer to identify when the peak storage or overtopping condition occurs and see the influence that the native infiltration capacity and rock storage might have on the surface storage performance. This is of particular interest when the below grade infiltration capacity is less than the above grade infiltration capacity for Facility Configurations A & B or anytime when flows beyond the Pollution Reduction storm event are allowed to bypass the growing medium to the rock storage for Facility Configurations E & F.

As the project designer becomes familiar with the PAC, additional applications may be identified to model variations in design. However, in order to reflect the conditions in the field, there are some guidelines for sizing and design:

- Design criteria are defined in Allowed and Recommended Ranges. The data entry can be outside recommended parameters, but additional documentation may be required at time of review to support the design. For example, greater porosity can be justified for the below grade storage component where additional void space is provided with chambers or perforated pipes. Entering data outside recommended parameters may result with the facility being reviewed under the Performance Approach.
- The PAC calculates the infiltration capacity by multiplying the respective design infiltration rate with the Bottom Area of the surface facility for planters, Infiltration Area at 75% Depth 1 for swales and basins, or Rock Storage Bottom Area for the below grade storage. The calculations do not track the wetted area as the flows enter and exit the facility to iterate an estimated variable infiltration rate, nor do they account for increased infiltration with increased head. Therefore, consideration should be given to expected performance when running the calculations with an oversized facility. In a model condition where the facility is oversized, the PAC will overestimate the performance by allowing the higher infiltration capacity whether the inflow has fully wetted the allocated infiltration area or not. The results will reflect smaller values for percent capacity used than might be observed. A facility with more optimized sizing will function more closely with the calculations.

- When designing with Facility Configuration E, two different “risers” are defined with the data entry as Storage Depth 1 and Storage Depth 2. The lower overflow “riser” at Depth 1 provides a direct connection to the rock storage reservoir, while the higher “riser” at Depth 2 represents the overflow elevation to the offsite discharge point. The lower “riser” has the capacity to collect and convey stormwater to the rock storage reservoir without overtopping the second “riser” to the discharge point.

Overview of PAC Calculations

This section describes the methodology used in the Presumptive Approach Calculator (PAC) for the calculations of hydrographs and facility routing. The intent of this section is to provide a summary of the concepts used by the PAC. The PAC uses a similar reservoir routing process as most hydrologic analysis software packages to size detention or infiltration facilities. However, the primary difference is that the PAC has the capability of running a Two-Stage Calculation. Two reservoir routing models run concurrently so the performance of the second stage calculation (below grade) can influence the performance of the first stage calculations (above grade). The output hydrograph from the first stage calculation serves as the inflow hydrograph for the second.

Hydrologic Methods

The PAC uses the Santa Barbara Urban Hydrograph (SBUH) method for all hydrologic calculations. This method is approved by the Bureau of Environmental Services (BES) for determining runoff when performing flow control calculations.

The SBUH method is based on the Soil Conservation Service (SCS) method, except that the SBUH method directly computes a runoff hydrograph without going through an intermediate process (unit hydrograph). Although the Soil Conservation Service is now called the Natural Resources Conservation Service (NRCS), the method is still commonly referred to as the SCS method. The SBUH method predicts a peak runoff rate and rainfall-runoff distribution based on the catchment characteristics including catchment area, curve number (CN) of the ground surface, and Time of Concentration (Tc). Further discussion of the SBUH method is provided in SWMM Santa Barbara Urban Hydrograph Method as well as guidance for determining a Tc for each of the catchments. The default CN value for impervious surfaces is 98.

The PAC uses the NRCS Type 1A, 24-hour storm distribution with a fixed 10-minute interval per SWMM. When using the PAC, the SBUH calculations will account for impervious areas entered by the project designer in accordance with the SWMM guidelines. However, the PAC can also be utilized under the Performance Approach

provided that supplemental support documentation is provided. Accordingly, the CN data entry will allow some flexibility in the modeling to reflect a weighted CN (of each catchment) for numerous conditions. Precipitation values for each modeled storm event are described in Stormwater Pollution Reduction Storm. The Pollution Reduction (PR) storm event is representative of 90% of the average annual rainfall and is used to size pollution reduction facilities. Refer to Stormwater Pollution Reduction Storm for additional discussion of the PR storm precipitation.

The PAC will generate a hydrograph for each of the five modeled storm events based on the data entered for each catchment. This data is then used by the PAC to evaluate the performance of the surface infiltration facilities.

SBUH uses two steps to synthesize the runoff hydrograph:

1. Computing the instantaneous hydrograph
2. Computing the runoff hydrograph

The instantaneous hydrograph, I_t (cfs), at each time step (d_t) is computed as follows:

$$I_t = 60.5R_tA/d_t$$

Where

R_t = Total runoff depth at time increment d_t (inches)

A = Area in acres

d_t = Time interval in minutes

The runoff hydrograph, Q_t , is then obtained by routing the instantaneous hydrograph I_t through an imaginary reservoir with a time delay equal to the time of concentration, T_c of the catchment basin. The following equation estimates the routed flow, Q :

$$Q_t = Q_{(t-1)} + w[I_{(t-1)} + I_t - 2Q_{(t-1)}]$$

Where

$$w = d_t / (2T_c + d_t)$$

d_t = time interval in minutes

The tabulated values of Q_t for each time step represent the runoff hydrograph that is utilized as the input hydrograph for the PAC.

Storage Capacity Calculations

The PAC offers four options for facility shapes to size a surface storage capacity for basins. Each has a different calculation to estimate the storage capacity. The Amoeba and Rectangle/Square facility shapes use the side slope to calculate available volume, which allows the project designer to roughly size a facility without needing to recalculate an upper surface area with each iteration, as would be required with the User Defined shape. The Swale facility shape includes a number of calculations to estimate the storage capacity accounting for swale geometry, longitudinal slope, number of segments, and berm heights. To simplify the sizing iterations, a designer may use the Rectangle/Square Facility shape to roughly size the facility and then the project designer may select a different shape to fine tune the design and more accurately represent the proposed condition. The Rock Storage capacity is a more simple volume calculation that accounts for the porosity of the rock aggregate.

Rectangle/Square

The PAC calculates volume by treating it as a trapezoidal basin where:

$$V = LWD + (L + W)XD^2 + \frac{1}{3} \pi X^2 D^3$$

$$A = A_{bottom} + A_{sides} + A_{corners}$$

$$A = LW + 2(L + W)XD + \pi(XD)^2$$

Where:

V = Storage in cubic ft

L = Bottom length of surface facility in ft

W = Bottom width of surface facility in ft

D = Depth of surface facility in ft

X = Side slope, (X:1) (H:V)

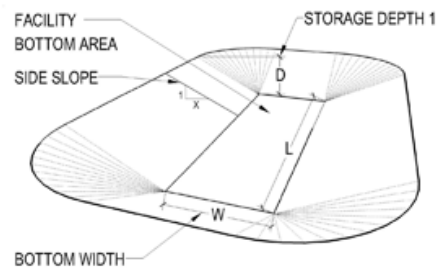

Amoeba

The amoeba shape can be selected for an organically-shaped facility that has both convex and concave curves. The volume is greatly affected by the perimeter length, so care should be given when approximating this value for early iterations. If the proposed facility will be more oval or round shaped with minimal or no concave curves, then the calculation would underestimate the storage volume and the User Defined shape may provide a more accurate calculation. The PAC calculates the volume using the following equation:

$$V = \frac{1}{2}DXP_{len} + A_1D$$

$$A = A_1P_{len}DX$$

Where:

V = Storage in cubic ft

D = Depth of surface facility in ft

X = Side slope, (X:1) (H:V)

P_{len} = Perimeter length of facility
bottom area in ft

A_1 = Bottom surface area of
surface facility in square ft

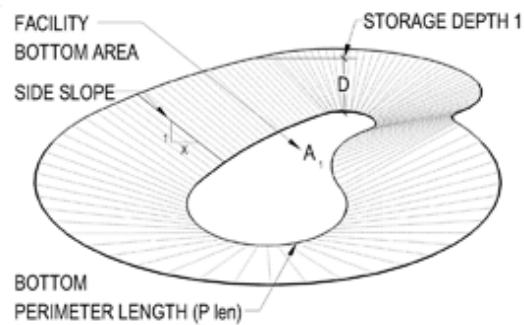

User Defined

The PAC calculates volume by the depth times the average of the top and bottom surface areas per the following equation:

$$V_{single-stage} = \frac{A_1 + A_2}{2}$$

$$V_{dual-stage} = \frac{A_1 + A_2}{2} + \frac{A_2 + A_3}{2}$$

Where:

V = Storage in cubic ft

D = Depth of surface facility in ft

A₁ = Bottom surface area of surface facility in square ft

A₂ = Surface area of surface facility at depth D in square ft

A₃ = Surface area of surface facility at secondary overflow depth
(Configuration E only)

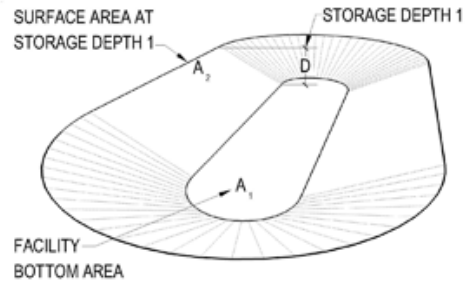

Swale

The swale facility type requires a more complex calculation to accurately model the infiltration area and surface storage volume than the calculation methodologies for the different basin shapes. These values are greatly affected by the swale size, shape, depth, number of segments, check dams and slope of the adjacent grade as well as configuration type. The PAC automates the calculation of these values given specific customizable swale parameters.

For Facility Configuration: A-D, E or F:

- # = Number of swale segments
- $L_{segment}$ = Length of swale segment
- L_{dam} = Check Dam Length
- S = Longitudinal Swale Slope
- W_{bottom} = Typical Bottom Width
- $X_{right} :1$ = Side Slope of right side of swale
- $X_{left} :1$ = Side Slope of left side of swale
- D_{ds} aka *Depth 1* = Downstream depth of swale created by a check dam or the overflow outlet
- $W_{landscape}$ = Width of landscape, usually measured from back of curb to sidewalk
- W_{rock} = Width of rock storage layer
- D_{rock} = Depth of rock storage
- V = Rock porosity
- *Depth 2* = Only used with configuration E. Maximum storage depth for above grade storage component before overtopping to the approved discharge. Refer to graphic of swale configuration E below.
- *Depth 3* = Only used with configurations C & F. Depth of rock storage available between the bottom of the facility and the invert of the outlet pipe. Refer to graphic of swale configuration F below.

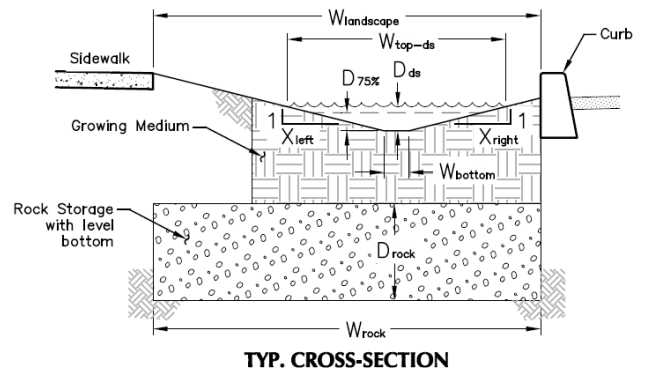

For Facility Configurations A¹, B, C & D²

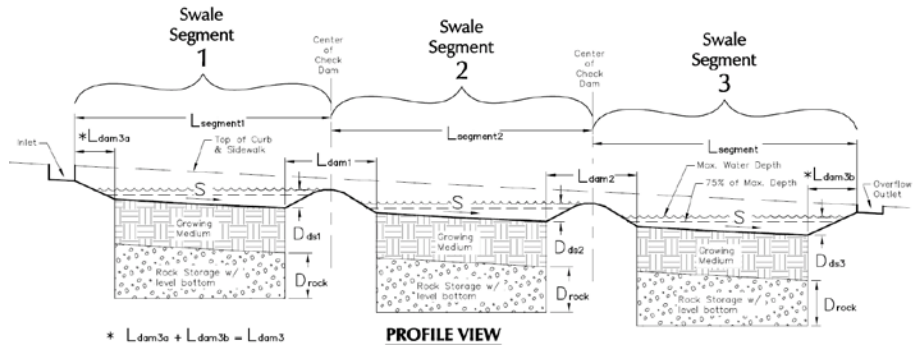

- ¹ For Configuration A, rock storage is eliminated.
- ² For Configurations C & D, all rock storage segments contain an underdrain that conveys filtered runoff to an approved discharge point.

For Facility Configuration E

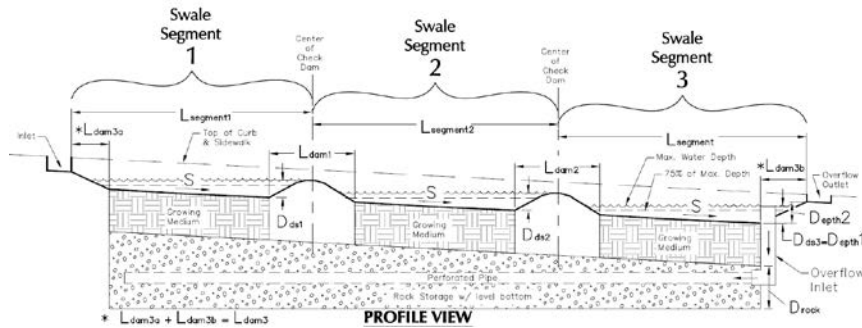

For Facility Configuration F

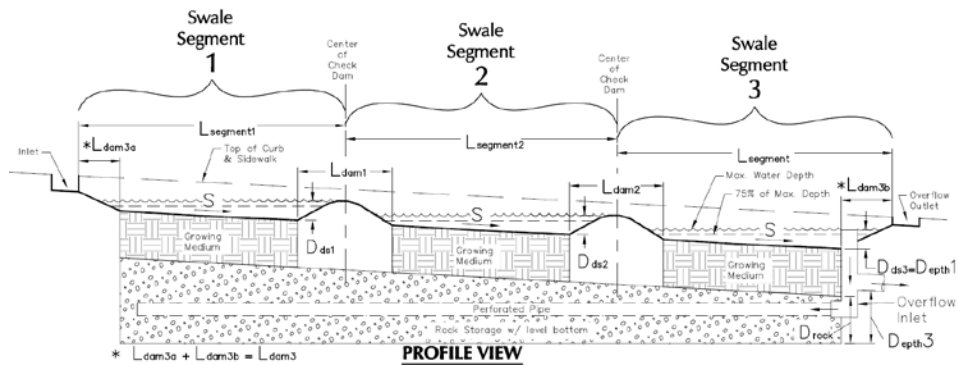

The below equations use the entered parameters to ultimately solve for:

- V_{surface} = surface volume
- $A_{75\%}$ = Infiltration Area @ 75% Full
- A_{rock} = Rock Storage Bottom Area
- V_{rock} = Rock Storage Volume

Swale Equations

$L_{\text{adjust}} = L_{\text{segment}} - \frac{1}{2}L_{\text{dam}}$ If $D_{\text{up}} = 0$, then calculate $L_{\text{adjust}2}$

$$L_{\text{adjust}2} = D_{\text{ds}} / S$$

$D_{\text{us}} = D_{\text{ds}} - SL_{\text{adjust}}$ If $D_{\text{up}} < 0$, then D_{us} is set to 0. If using configuration E, replace D_{ds} with Depth 2

$$W_{\text{top-ds}} = W_{\text{bottom}} + D_{\text{ds}}X_{\text{right}} + D_{\text{ds}}X_{\text{left}}$$

$$W_{\text{top-us}} = W_{\text{bottom}} + D_{\text{us}}X_{\text{right}} + D_{\text{us}}X_{\text{left}}$$

$A_{\text{ds}} = \frac{1}{2}(W_{\text{bottom}} + W_{\text{top-ds}})D_{\text{ds}}$ If using configuration E, replace D_{ds} with Depth 2

$$A_{\text{ds}} = \frac{1}{2}(W_{\text{bottom}} + W_{\text{top-us}})D_{\text{us}}$$

$V_{\text{surface}} = \frac{1}{2}(A_{\text{ds}} + A_{\text{us}})L_{\text{adjust}}$ If $D_{\text{up}} = 0$, replace L_{adjust} with $L_{\text{adjust}2}$

$$D_{75\%ds} = \frac{3}{4}D_{\text{ds}}$$

$D_{75\%us} = D_{75\%ds} - SL_{\text{adjust}}$ If value < 0 , then $D_{75\%us}$ is set to 0

$$L_{\text{adjust}3} = D_{75\%ds} / S$$

$$W_{\text{top-75\%ds}} = W_{\text{bottom}} + D_{75\%ds}X_{\text{right}} + D_{75\%ds}X_{\text{left}}$$

$$W_{\text{top-75\%us}} = W_{\text{bottom}} + D_{75\%us}X_{\text{right}} + D_{75\%us}X_{\text{left}}$$

$A_{75\%} = \frac{1}{2}(W_{\text{top-75\%ds}} + W_{\text{top-75\%us}})L_{\text{adjust}}$ If $D_{75\%us} = 0$, replace L_{adjust} with $L_{\text{adjust}3}$

$$L_{rock} = L_{segment} - L_{dam}$$

If using configuration E or F, replace equation with...

$$L_{rock} = \sum_{i=1}^n L_{segment,i} - L_{dam,n}$$

$$A_{rock} = W_{rock}L_{adjust}$$

$$V_{rock} = W_{rock}L_{adjust}D_{rock}\phi_{rock}$$

If using configurations C or F, replace D_{rock} with Depth 3 where $\text{Depth } 3 < D_{rock}$

Rock Storage

The volume of the rock storage is calculated by treating it as a box with a given porosity where:

$$V = A_1 D v$$

Where:

V = Storage in cubic ft

A_1 = Bottom surface area of rock storage in square ft

D = Depth of rock storage in ft

v = Porosity of rock

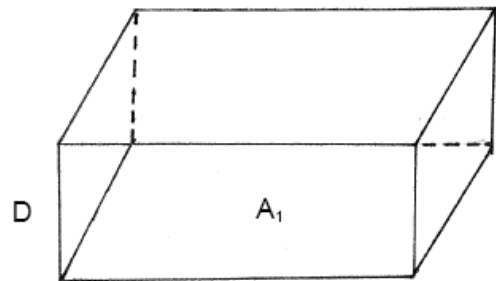

Reservoir Routing

Reservoir routing is a method for routing a modeled storm hydrograph through a modeled reservoir (in this case a surface infiltration facility) in order to determine the peak flow attenuation and flow storage that occurs. This process changes the pattern of flow with respect to time. The purpose of reservoir routing is usually to reduce and delay the peak flow. The routing procedure used by the PAC accounts for the infiltration through both the growing medium and the native soil with a two-stage calculation (with the exception of Facility Configurations C & D that use only the first of the two-stage calculation).

Two-Stage Calculations

The PAC uses the methodology summarized above for both the above grade portion of the surface infiltration facility as the runoff passes through the growing medium, as well as the rock storage reservoir at the interface with the native subgrade. The routing process is similar to most hydrologic analysis software packages to size detention or infiltration facilities. However, the primary difference is that the PAC has the capability of running a two-stage calculation, or two reservoir routing models run concurrently so the performance of the second stage calculation (below grade) can influence the performance of the first stage calculations (above grade). The two stage calculations are performed for each modeled storm event, and the output hydrograph from the first stage calculation serves as the inflow hydrograph for the second.

Stage I Calculations

The first stage of the two-stage calculation evaluates the performance of the above grade storage component. The percolation capacity of this component is a fixed rate based on the Facility Bottom Area for Planters or the infiltration area at 75% of Depth 1 for Swales and Basins times the infiltration rate of the growing medium (assumed to be 2 inches per hour). The PAC routes the storm event through the surface facility tracking the volume that percolates and the excess volume that is stored in the above grade storage component. As the modeled storm event subsides, the PAC continues to track the stored volume of runoff as it percolates through the growing medium. Runoff does not reach the below grade storage component until it has passed through the growing medium or overtopped the bypass pipe to the rock storage in Facility Configurations E or F. Any flows that overtop to the approved discharge under Facility Configurations A, B, C & D are tracked separately and are not rerouted to the below grade storage. Depending upon the Facility Configuration, the model will sometimes include a lag time based on the depth and infiltration rate of the growing medium. (See 3.6 for discussion of lag time.)

For Facility Configuration A where there is no below grade rock storage, the PAC uses the lesser infiltration capacity of the surface facility or below grade area. The PAC assumes a constant infiltration capacity for the surface storage that does not vary as the water level rises or falls and wets the side slopes. However, the PAC does track the rock storage capacity during the concurrent Stage II Calculations for Facility Configurations B & E. If the rock storage becomes full at a particular time step of the calculations, then the PAC compares the above grade and below grade infiltration capacity and uses the lesser of the two infiltration rates until the rock storage

volume is less than full. This allows the model to limit the rate of percolating or overflowing water into the rock storage during the Stage I calculations that cannot be accommodated below grade.

This influence of the below grade capacity does not affect Facility Configuration D since the facility assume no infiltration and a free flowing rock subgrade; thus, the PAC does not perform the Stage II Calculations for Configuration D. For Facility Configurations C and F, the below grade capacity does not influence the infiltration capacity of the surface facility, since the below grade overflow to approved discharge will alleviate any backwater effect created by a full rock storage condition.

Stage II Calculations

The second stage of the two-stage calculation evaluates the performance of the below grade storage component. The percolation capacity of this component is a fixed rate based on the Rock Storage Bottom Area and the design infiltration rate of the native soil at the bottom of the facility. The PAC does not account for any increased head or wetted side slopes to increase the infiltration capacity. The PAC routes flows that percolate through the growing medium, or that enter the bypass pipe to the rock storage with Facility Configurations E or F, that are generated by the Stage I calculations. The PAC assumes free vertical and lateral flow through the drain rock and tracks the volume of water that reaches the native subgrade and any excess volume that is stored in the below grade storage component. If the below grade storage capacity is exceeded at any particular time step for Facility Configurations B or E, the PAC will limit the amount of water that can pass through the growing medium or bypass pipe (Facility Configuration E only), and influence the outflow from the Stage I calculations. In some cases where there is a lag time modeled for the flows percolating through the growing medium, and the modeled percolating flows encounter a full rock storage condition, then under Facility Configurations B or E the PAC evaluates whether there is any available capacity in the above grade storage component and adds the incremental volume to the surface storage as available. (See 3.6 for discussion of lag time.) If the surface storage is also full, then the incremental flow is added to any overtopping flows to the approved discharge at that time step. The Stage II calculations are skipped for Facility Configuration D, as the rock subgrade is assumed to be free flowing to the underdrain pipe and no below grade infiltration calculations are necessary. The Stage II Calculations are performed for Facility Configuration F, but any flows that cause the rock storage to exceed capacity are routed to the overflow pipe without influencing the Stage I Calculations.

Facility Configuration A or B

Facility configuration A uses only a single-stage calculation. Configuration B uses the two-stage calculation. In the first stage of the calculations, the flow that percolates through the growing medium is tracked at each time step. The flows follow the inflow hydrograph up to the surface facility infiltration capacity flow rate. Note that the surface infiltration capacity can be affected by the below grade storage capacity. Any inflow that exceeds this infiltration capacity will be stored in the above grade portion of the surface facility, rounded up to the next 10 cubic feet, and be tracked at each time step. If the surface capacity of the facility is exceeded, an overtopping flow at each time step is generated. Any overtopping flows generated during the first stage of the calculations are illustrated in the Stage I graph as “Flow Overtopping to Approved Discharge”. For Configuration B, the PAC also generates a separate outflow hydrograph that is limited to the runoff that percolates through the growing medium with a lag time rounded up to the next 10 minutes.

This separate outflow hydrograph from the first stage is the inflow hydrograph for the second stage calculations. Just like the Stage I calculations, the flow that infiltrates to the native subgrade is tracked at each time step and any required storage volume in the below grade rock storage portion of the facility is also tracked at each time step. If the rock storage capacity is exceeded during any particular time step, the PAC compares the above grade and below grade infiltration capacity. Since the below grade and above grade storage are hydraulically connected, it is important to identify when the full condition occurs so that the Stage I infiltration capacity can be reduced if the Below Grade Infiltration Capacity is less than the Above Grade Infiltration Capacity. The model can account for this reduction in infiltration capacity because the Stage I and Stage II calculations are run concurrently.

Note that for Facility Configuration A there is no rock storage, and the below grade storage component is assumed to be 100% full. The calculations are still the same. As noted above, when the Stage II calculations indicate that the below grade storage is full, the PAC compares the above grade and below grade infiltration capacity and models the Stage 1 calculations with the lesser of the two. Since the flows reaching the native soil are limited to what can pass through the growing medium, then the below grade infiltration capacity should never be exceeded and the flows into the “rock storage” would equal the flow capacity out. Any overtopping flows from the Stage 1 calculations represent the output hydrograph for each modeled storm event.

A facility should not overtop during the first stage of the calculations for a modeled PR storm event to meet pollution reduction requirements. A facility with a hierarchy goal of category 1 should not overtop to during a modeled 10-yr storm event during first stage calculations.

Facility Configurations C or D

Two-stage calculations are used for these configurations. Configuration D assumes a zero-volume rock gallery, and an impervious native infiltration rate, effectively bypassing the stage-two calculation.

In the Stage I calculations, the flow that percolates through the growing medium is tracked at each time step. The flows follow the inflow hydrograph up to the surface facility infiltration capacity flow rate. Any inflow that exceeds this infiltration capacity will be stored in the above grade portion of the surface facility, rounded up to the next 10 cubic feet, and be tracked at each time step. If the surface capacity of the facility is exceeded, an overtopping flow at each time step is generated. The PAC also generates a separate outflow hydrograph that is limited to the runoff that percolates through the growing medium with a lag time. Since the overtopping “riser” and the underdrain are hydraulically connected the “Flow Overtopping to Approved Discharge” includes the overtopping hydrograph.

The percolation hydrograph from the Stage I calculations is the input hydrograph for the Stage II calculations. Just like the Stage I calculations, the flow that infiltrates to the native subgrade is tracked at each time step and any required storage volume in the below grade rock storage portion of the facility is also tracked at each time step. If the rock storage capacity is exceeded during any particular time step, the PAC immediately adds the excess to the overflow hydrograph, “Flow Overtopping to Approved Discharge”, with along with overflows from Stage I calculations.

A facility that overtops the modeled PR storm event does not meet the pollution reduction requirements.

Facility Configuration E

This facility configuration uses the two-stage calculations. In the first stage of the calculations, the flow that percolates through the growing medium is tracked at each time step. The flows follow the inflow hydrograph up to the surface facility infiltration capacity flow rate. Note that the surface infiltration capacity can be affected by the below grade storage capacity. Any inflow that exceeds this infiltration capacity will be stored in the above grade portion of the surface facility, rounded up 10 cubic feet, and be tracked at each time step. As the surface capacity

of the facility at Depth 1 is exceeded, an overtopping flow at each time step is generated. The model assumes that all flow generated in this overtopping condition is directed to the rock storage. None of this flow is directed to the “riser” at Depth 2 at this point in the calculations. The combined flows of the runoff percolating through the growing medium with a lag time, and the flows overtopping the “riser” at Depth 1 represent the outflow hydrograph for each modeled storm event.

This combined outflow hydrograph from the first stage is the inflow hydrograph for the second stage calculations. Just like the Stage I calculations, the flow that infiltrates to the native subgrade is tracked at each time step and any required storage volume in the below grade rock storage portion of the facility is also tracked at each time step. If the rock storage capacity is exceeded during any particular time step, the PAC compares the above grade and below grade infiltration capacity. Since the below grade and above grade storage are hydraulically connected, it is important to identify when the full condition occurs so that the Stage I infiltration capacity can be potentially reduced to the Below Grade Infiltration Capacity in the event that it is less than the Above Grade Infiltration Capacity. The PAC can account for this reduction in infiltration capacity because the Stage I and Stage II calculations are run concurrently.

At some point in the model these flows overtopping the “riser” at Depth 1, or in some cases the percolating flows from the Stage I calculations when a lag time is applied, the model will try to add flows to the below grade storage when it is already full. When this occurs the PAC will take this excess volume at each time step and add it to the surface storage volume at the corresponding time step. The calculations then evaluate whether the surface storage volume exceeds the surface capacity at Depth 2. Any overtopping flows are illustrated in the Surface Facility Modeling graph as “Overflow to Approved Discharge”.

A facility should not overtop to the approved discharge during the first stage of the calculations for a modeled PR storm event to meet pollution reduction requirements. A facility with a hierarchy goal of Category 2 should not overflow to the approved discharge during a modeled 10-yr storm event.

Facility Configuration F

This facility configuration uses the two-stage calculations. In the first stage of the calculations, the flow that percolates through the growing medium is tracked at each time step. The flows follow the inflow hydrograph up to the surface facility infiltration capacity flow rate. Since the outflow pipe to the approved discharge is provided below grade, the surface infiltration capacity will not be affected by the

below grade storage capacity. Any inflow that exceeds this infiltration capacity will be stored in the above grade portion of the surface facility, rounded to the next 10 cubic feet, and be tracked at each time step. As the surface capacity of the facility at Depth 1 is exceeded, an overtopping flow at each time step is generated. The model assumes that all flow generated in this overtopping condition is directed to the rock storage. None of this flow is directed to the “Overflow to Approved Discharge” at this point in the calculations. The combined flows of the runoff percolating through the growing medium with a lag time and the flows overtopping the “riser” at Depth 1 represent the outflow hydrograph for each modeled storm event.

This combined outflow hydrograph from the first stage is the inflow hydrograph for the second stage calculations. Just like the Stage I calculations, the flow that infiltrates to the native subgrade is tracked at each time step and any required storage volume in the below grade rock storage portion of the facility is also tracked at each time step. If the rock storage capacity is exceeded during any particular time step, an overtopping flow is generated. Any overtopping flows generated during the second stage of the calculations are illustrated in the Below Grade Modeling graph as “Overflow to Approved Discharge”.

A facility should not overtop to the approved discharge during the second stage of the calculations for a modeled PR storm event to meet pollution reduction requirements. A facility with a hierarchy goal of Category 2 should not overflow to the approved discharge during a modeled 10-yr storm event.

Overflow Calculations

In the event that the project designer has selected a facility configuration that assumes no infiltration, the second stage calculation is not necessary and the outflow hydrograph from the first stage represents the outflow from the facility. When an infiltration facility is selected, both the first and second stage calculations are performed. Since these facilities are designed to infiltrate at least a portion of the storm event, the outflow from the facility is only the portion of the catchment runoff that overflows to the discharge point.

In addition, some facilities can be sized as Stormwater Hierarchy Category 2, and release to a downstream facility that is sized for infiltration, such as a drywell UIC. In these cases an overflowing condition is acceptable, and the PAC can track the outflow hydrograph that overflows the facility. The project designer can export the output hydrograph table from the PAC for use in a separate detention sizing software to gain “partial credit” for the flow attenuation provided by the facility.

Lag Time

The PAC calculations account for a lag time or delay before reaching the below grade storage for water that percolates through the growing medium. In accordance with the SWMM guidelines, the presumed infiltration rate for the growing medium is 2 inches per hour. As the water passes through the growing medium it moves more quickly than 2 inches per hour. Similar to water passing through a funnel, the water from the surface must travel more quickly through the smaller voids in the growing medium per the continuity equation:

$$Q = \bar{V}A$$

Where:

Q = Flow

\bar{V} = Average Velocity

A = Cross Sectional Area of Pore Space

As a unit of volume of water percolates from the surface, that same volume of water enters the growing medium. Within a square foot of soil, the cross-sectional area available to transmit water is equal to the porosity, or void fraction, ϕ

$$Q / ft^2 = \bar{V}\phi$$

The growing medium is estimated to have 30% void space (ϕ_{GM}) as opposed to the surface that has 100% void space (ϕ_{SURF}). Instead of traveling 2 inches per hour through the growing medium, the water moves at $6.\bar{6}$ inches per hour, taking 2.7 hours to pass through an 18 inch depth of growing medium. These values are derived from the following equations:

$$Q_{surf} = Q_{gm}$$

$$\bar{V}_{surf}\phi_{surf} = \bar{V}_{gm}\phi_{gm}$$

$$\frac{2in}{hr} * 1 = \bar{V}_{gm} * 0.3$$

$$\bar{V}_{gm} = \frac{6.\bar{6}in}{hr}$$

$$t = \frac{\bar{D}_{gm}}{\bar{V}_{gm}} = \frac{18in}{\frac{6.6in}{hr}} = 2.7hrs = 162min$$

The PAC model calculates hydrograph values on 10-minute intervals. The lag time is rounded up to the next 10-minute interval. Thus, a lag time of 0.1 minute would shift the outflow hydrograph one interval, or 10 minutes. A time lag of 162 minutes would shift the outflow hydrograph 17 intervals, or 170 minutes.

There are some conditions where the lag time is not applied to the calculations. The lag time is always applied to Facility Configurations C, D and F, but the lag time is reduced to zero under Facility Configurations A, B and E when the below grade infiltration capacity is less than the above grade infiltration capacity. The reason for this discrepancy is to minimize the potential for the model to allow surface flows to percolate through the growing medium with the Stage I calculations during a time step when the rock storage below is already full. When there is no lag time, the Stage I calculations recognize the full below grade condition immediately and limit the surface percolation rate during the same time step to the slower below grade infiltration capacity. There are instances where this can still occur, but the PAC calculations try to accommodate for this by adding the flows back to the surface storage at the corresponding time step.

Sizing Methodology

The reservoir routing process of the PAC sizing tool is similar to the Storage Indication Method used in most hydrologic software.

The equation used to evaluate the facility at each time step without overtopping is:

$$V_{IN} - V_{OUT} = V_{STORAGE_REQUIRED}$$

Where:

$$V_{STORAGE_REQUIRED} < V_{STORAGE_AVAILABLE}$$

Where:

V_{IN} = Stormwater volume into the facility every 10 minute interval (runoff from site)

V_{OUT} = Stormwater volume out of the facility every 10 minute interval (infiltration through growing medium)

$V_{STORAGE_REQUIRED}$ = Cumulative difference of $V_{IN} - V_{OUT}$

$V_{STORAGE_AVAILABLE}$ = Total reservoir volume available to store $V_{STORAGE_REQUIRED}$

V_{IN} is calculated using the Santa Barbara Urban Hydrograph method with a NRCS Type 1A storm distribution at a 10-minute interval with the following assumptions or project designer supplied data entry:

P = 24-hour model storm event precipitation per BES in inches (PR, 2-yr, 5-yr, 10-yr or 25-yr event)

A = Impervious area of catchment draining to facility in acres

CN = Weighted curve number for impervious area

T_c = Time of concentration for catchment area in minutes (5 minutes minimum)

This yields a runoff flow rate (Q_{IN}) for every 10 minute interval (T_{10min}) throughout the storm event.

V_{IN} at each time step can now be calculated from:

$$Q = \frac{V}{T}$$

$$\therefore V_{IN} = Q_{IN} * T_{10min}$$

V_{OUT} at each time step is obtained by first calculating the infiltration flow rate (Q_{OUT}) through the growing medium or native subsoil, depending upon the stage being modeled, using the following:

$$I * A_{75\%} = Q_{OUT}$$

$$\therefore V_{OUT} = Q_{OUT} * T_{10min}$$

Where:

I = Soil infiltration rate = 2 inches/hour for growing medium or the design infiltration rate for the native soil (field tested rate with a correction factor applied). The soil infiltration rate is then converted from inches/hour to ft/sec.

$A_{75\%}$ = Vertically projected area of the facility at 75% of the maximum depth. Bottom area where infiltration occurs in square feet (bottom area of surface facility or bottom area of rock storage).

$V_{STORAGE_AVAILABLE}$ at each time step is obtained by first calculating:

$$V_{IN} - V_{OUT} = V_{DIFF}$$

If: $V_{DIFF} \leq 0$ then V_{OUT} exceeds V_{IN} and the facility remains empty or empties by that amount if the facility had previously stored excess runoff during previous 10 minute intervals.

If: $V_{DIFF} > 0$ then V_{IN} exceeds V_{OUT} and the facility will need to store the excess

volume as well as any excess volume from previous 10 minute intervals where this was also true.

Therefore, cumulative required storage volume is calculated after each 10 minute interval at some time t+n by the following:

$$V_{DIFF,t} + V_{DIFF,t+1} + V_{DIFF,t+2} \dots V_{DIFF,t+n} = \sum_{i=t}^n V_{DIFF,i} = V_{STORAGE_REQUIRED,t+n}$$

$V_{STORAGE_AVAILABLE}$ at each time interval can then be obtained from the following:

$$V_{STORAGE} - V_{STORAGE_REQUIRED} = V_{STORAGE_AVAILABLE}$$

Where:

$V_{STORAGE}$ = Total reservoir volume below overflow or outflow structure (facility reservoir capacity)

If: $V_{STORAGE_AVAILABLE} < 0$ then the facility will overflow, and conversely

If: $V_{STORAGE_AVAILABLE} \geq 0$ then the facility will have capacity.

At some point in time during the storm, the inflow will be less than the infiltration capacity. Any water stored above grade will then be added to the inflow hydrograph until it is depleted.

If: $Q_{IN} < Q_{CAP}$ and $V_{STORED} > 0$, then $Q_{OUT} = Q_{IN} + Q_{STORAGE}$

where $Q_{STORAGE}$ is the lesser of $Q_{CAP} - Q_{IN}$ and $\frac{V_{STORED}}{\Delta t}$, rounded up to the next 10 cubic feet.

The PAC evaluates the results from the reservoir routing and identifies whether the facility is predicted to overtop during a particular storm event. A "PASS" or "FAIL" result is generated depending upon the hierarchy goals selected for the facility. The PAC further identifies the maximum % capacity of the above grade and below grade storage components to allow the designer to optimize the design. If the facility fails to infiltrate the entire modeled storm event, it will identify the volume of overflow. When Stormwater Hierarchy Category 3 or 4 is selected, the PAC will generate an output hydrograph for multiple modeled storm events.

Glossary

BOTTOM OF FACILITY. Bottom of facility is where the facility interfaces with the native subgrade. This is either at the bottom of the rock storage or at the bottom of the growing medium where no below grade rock storage is provided.

BOTTOM PERIMETER LENGTH. Dimension in feet of the perimeter measured at the toe of side slopes for basins with an amoeba shape.

BOTTOM WIDTH. Dimension in feet (either length or width) between toe of side slopes for basins or between sidewalls for a planter at the bottom of the above grade storage component.

CATCHMENT. The extent of a drainage basin that contributes to a specific stormwater facility. The area can be from one surface or a combination of impervious surfaces, such as roof area and hardscape.

CORRECTION FACTOR COMPONENT. Variable correction factor applied to field tested native soil infiltration rate based on the infiltration testing procedure (See [Section 2.3.6](#)).

DESIGN INFILTRATION RATE. Infiltration rate used in PAC calculations for Native or Imported Growing Medium. Design infiltration rate for growing medium is fixed at 2 inches per hour per BES SWMM guidelines. Design infiltration rate for the native soils is the field-tested infiltration rate with a correction factor applied.

FACILITY BOTTOM AREA. Surface area in square feet of the above grade storage component at stage zero. Area measurements limited to “level” area at toe of side slopes for basins or at the sidewall for a planter.

FACILITY CONFIGURATION. Pipe and facility configuration applied to any of the three facility types. Selection determines the calculations performed when sizing the facility.

FACILITY SHAPE. Various facility shapes with different volume calculations to more accurately estimate surface volumes. Amoeba shape is an organically-shaped facility that has both convex and concave curves. Rectangle/Square shape is a rectilinear facility. User Defined shape facilities allow data entry of surface areas at stage zero and at the defined Depth 1. The Amoeba or Rectangle/Square shapes use the side slope to calculate volumes and allow the project designer to vary the depth of the facility without having to recalculate a new surface area with each iteration.

FACILITY SIDE SLOPE. The horizontal component for the side slope on the above grade storage component of the facility based on the following X:1 (H:V).

FACILITY TYPE. Type of surface infiltration facility including Swale, Planter or Basin. Different design criteria apply to each facility type. Refer to [Section 2.3](#) for additional discussion of each facility type.

FREEBOARD. The vertical distance between the overflow elevation (design water surface elevation) and the elevation at which overtopping of the structure or facility that contains the water would occur.

GROWING MEDIUM DEPTH. Depth of imported growing medium in inches. A deeper section of growing medium can increase the lag time before the percolating runoff reaches the underdrain or below grade rock storage.

HIERARCHY CATEGORY. Stormwater management requirement for discharge/infiltration. The Hierarchy was set up to protect the watershed health and mimic pre-developed hydrologic conditions to the maximum extent feasible. Refer to [Section 1.3.1](#) for further discussion of Stormwater Hierarchy Categories 1 through 4.

IMPERVIOUS AREA. Projected area of impervious surfaces collected within the catchment in square feet.

PRE-DEVELOPMENT CURVE NUMBER, CN_{pre} . Weighted curve number at pre-developed conditions (Lewis & Clark era) for the area requiring stormwater management. Refer to Santa Barbara Urban Hydrograph Method for CN values of different impervious surfaces.

POST-DEVELOPMENT CURVE NUMBER, CN_{post} . Weighted curve number value for the post-development impervious area requiring stormwater management. Refer to SWMM Appendix C.1 for CN values of different impervious surfaces.

INFILTRATION AREA @ 75% DEPTH 1. Calculated water surface area when surface facility is filled to 75% of maximum depth at Depth 1. This value is multiplied by the Growing Medium Design Infiltration Rate to determine the infiltration capacity for the above grade storage component.

INFILTRATION CAPACITY. Calculated infiltration capacity for above grade and below grade storage components of the facility. The value is the product of the Design Infiltration Rate and the surface area allocated to infiltration.

INFILTRATION TESTING PROCEDURE. Test procedure used to measure field infiltration rates of native subgrade. Refer to [Section 2.3.6](#) for direction on number and locations of testing and how to report results for multiple infiltration tests.

NATIVE SOIL FIELD TESTED INFILTRATION RATE (ITEST). Field tested infiltration rate of native subgrade. Refer to [Section 2.3.6](#) for direction on number and locations of testing and how to report results for multiple infiltration tests.

OVERFLOW VOLUME. Calculated volume of water that overflows to the downstream facility, the discharge point, or the escape route during the PAC calculations for the respective storm event.

POLLUTION REDUCTION (PR). The Pollution Reduction (PR) storm event is representative of 90% of the average annual rainfall and is used to size pollution reduction facilities. Refer to Stormwater Pollution Reduction Storm for additional discussion of the PR storm precipitation.

ROCK CAPACITY USED. The maximum calculated percentage of rock storage capacity used during the PAC calculations for the respective storm event.

ROCK STORAGE BOTTOM AREA. Surface area in square feet of the below grade storage component at the bottom of facility. Side slopes for below grade storage are assumed to be vertical and area measurements are limited to “level” area at toe of side walls. Rock storage bottom area cannot exceed surface area at maximum above grade storage depth for basins, the landscape area for swales, or the limits of the sidewalls for planters.

ROCK STORAGE CAPACITY. Storage capacity of below grade rock storage. This value is calculated by multiplying the total volume of the below grade rock available for storage by the porosity for the rock material.

ROCK STORAGE DEPTH. Depth of below grade rock storage in inches.

ROCK POROSITY. Void fraction of rock placed in below grade storage component. Porosity can vary for a variety of aggregate.

SIZING RATIO. Ratio of total area of the facility to the impervious catchment area.

STORAGE DEPTH 1. Maximum storage depth in inches for the above grade storage component before overtopping to the offsite discharge point/overflow riser.

STORAGE DEPTH 2. Maximum storage depth in inches for above grade storage component before overtopping to the offsite discharge point.

STORAGE DEPTH 3. Depth of rock storage available in inches between the Bottom of Facility and the invert of the outlet pipe.

SURFACE AREA AT STORAGE DEPTH 1. Surface area in square feet of the above grade storage component at stage Depth 1 for User Defined Facility Shape.

SURFACE AREA AT STORAGE DEPTH 2. Surface area in square feet of the above grade storage component at stage Depth 2 for User Defined Facility with Facility Configuration E.

SURFACE CAPACITY USED. The maximum calculated percentage of surface storage capacity used during the PAC calculations for the respective storm event.

SURFACE CAPACITY @ DEPTH 1. The calculated surface storage volume available at Depth 1 based on the dimensional data provided for the facility.

SURFACE CAPACITY @ DEPTH 2. The calculated surface storage volume available at Depth 2 based on the dimensional data provided for the facility.

TIME OF CONCENTRATION, T_c , MINUTES. The amount of time it takes stormwater runoff to travel from the most distant point (measured by travel time) on a particular site or drainage basin to a particular point of interest.

TOTAL FACILITY AREA. Calculated top area in square feet of a facility based on the dimensional data entered on the PAC. For a basin, this includes the freeboard area of the facility and for a swale this includes the entire width of the landscape strip.

Allowed and Recommended Ranges

Data Field	Facility Types	Recommended Range		Unacceptable values	Default Value
		Minimum	Maximum		
Impervious Area	n/a	0	43,560	≤0	0
Pre-Development Curve Number	n/a	0	100	≤0, ≥100	72
Post-Development Curve Number	n/a	0	100	≤0, ≥100	98
Time of Concentration (min)	n/a	0	50	≤0	5
$I_{(test)}$ for Native Soil (in/hr)	n/a	0.5	20	≤0	0
Storage Depth 1 (in)	Planter	6	18	≤0	-
Storage Depth 2 (in)	Planter	6	18	<Storage Depth 1	-
Facility Side Slope, h/v (ft/ft)	Basin	3	10	<0	3
Storage Depth 1 (in)	Basin	6	36	≤0	-
Storage Depth 2 (in)	Basin	6	36	<Storage Depth 1	-
Bottom Perimeter Length (ft)	Basin	Circumference of a circle with the stated facility bottom area	n/a	<Circumference of a circle with the stated facility bottom area	-
Surface Area at Storage Depth 1 (ft ²)	Basin	Facility Bottom Area	n/a	≤0	-
Surface Area at Storage Depth 2 (ft ²)	Basin	Surface Area at Storage Depth 1	n/a	<Surface Area at Storage Depth 1	-
Freeboard (in)	Basin (Rectangular, Amoeba)	0	n/a	<0	-
Facility Bottom Area (ft ²)	Planter/Basin	10	n/a	≤0 (Flat Planter) <0 (Basin)	-
Facility Bottom Width (ft)	Planter/Basin	2	n/a	<0 (Basin, Planter) ≤0 (Flat planter)	-
Growing Medium Depth (in)	Planter/Swale/Basin	18	36	≤0	18

Data Field	Facility Types	Recommended Range		Unacceptable	Default
Rock Storage Bottom Area (ft ²)	all	0	Facility Surface Area at Max Depth	<0	-
Rock Storage Depth (in)	Planter/Basin	6	48	≤0	12
Rock Porosity (ft ³ /ft ³)	all	0.3	0.4	≤0, ≥1	0.3
Storage Depth 3 (in)	all	6	Rock Depth + Growing Medium Depth	<0	-
Segment Length (ft)	Swale	5	n/a	≤0	6
Check Dam Length (ft)	Swale	2	n/a	<0	1
Slope, v/h (ft/ft)	Swale	0	n/a	<0	0.02
Swale Bottom Width (ft)	Swale	0	n/a	<0	2
Right Side Slope, h/v (ft/ft)	Swale	3	10	<0	3
Left Side Slope, h/v (ft/ft)	Swale	3	10	<0	3
Downstream Depth (in)	Swale	6	12	≤0	9
Landscape Width (ft)	Swale	4 feet or bottom width and width from side slopes	n/a	≤0	8
Rock Width (ft)	Swale	0	Landscape Width	≤0	8
Rock Depth (in)	Swale	0	48	≤0	12
Storage Depth 2 (in)	Swale	6	12	≤0	-

Appendix B. Recommended Guidance for Culverts and Outfalls

The following information is intended to provide guidance in designing stormwater outfalls and surface water culverts in a way that provides multiple benefits to watersheds, not just conveyance. Each site is unique and a number of additional requirements may also apply. The format is written similar to that of the facility design criteria found in Section 2.3.4 for ease of readability, but none of the design information is a requirement of the Stormwater Management Manual. It includes the following sections:

B.1. Culverts and other water crossing structures	2
B.2 Outfalls.....	14
B.3. Reference Material	24

B.1. Culverts and other water crossing structures

Culverts and other water crossing structures allow water to flow under a road or other constructed obstructions along drainageways. Proper sizing, placement, and design of culverts and other water crossing structures can reduce impacts to conveyance, water quality and watershed processes. Improperly sized or poorly placed culverts can change hydraulic conditions that alter or interrupt the transport of woody debris and sediments, and can change groundwater/surface water interactions. Poorly designed culverts and bridges can induce major channel and bank erosion that threatens to undermine roadways, or impede flood flow conveyance, that in turn causes flooding and failure of roadways.

Poorly designed road crossings can prevent fish from migrating to spawning and rearing habitats. Over time, this can result in degradation of the biological productivity of the stream system and a net reduction in ecological benefits. Culverts can also restrict or block wildlife passage.

Drainageway conveyance, including natural or manmade channels, is protected through drainage reserves (see [Section 1.3.4](#) and [Section 2.3.4.20](#)). Drainage reserves are no build areas that require approval from BES for any encroachments. Culverts and other water crossing structures constitute a channel encroachment. Crossings over open channels should be designed to maintain continuity of flows upstream and downstream of the crossing or culvert, minimize negative effects on watershed processes and ecological functions.

Summary of Analysis and Design Methods

This section provides a brief description of hydrologic analysis and design methodologies for open-bottom and natural-bed box culverts. Detailed design requirements and procedures are not included here, but can be found in reference documents listed below and cited in this section.

- Hydrologic analysis requirements for culverts in the public right-of-way or otherwise owned by the City of Portland are provided in chapter six of the Portland Sewer and Drainage Facilities Design Manual (BES 2007).
- Culvert design requirements and procedures are detailed in Chapter 8, Appendix A and Appendix J of the Portland Sewer and Drainage Facilities Design Manual (BES 2007).
- Culvert design guidance for fish passage is provided in the Oregon Department of Fish and Wildlife Fish Passage Criteria (ODFW 2004) and related statutes, the Oregon Road/Stream Crossing Restoration Guide

(ODFW 1999), and the Washington Department of Fish and Wildlife Design of Road Culverts for Fish Passage (WDFW 2003).

- Permits from the US Army Corps of Engineers and the Oregon Division of State Lands may be required.

Additional Design Information

Culverts constructed under Public Works Permits that would be owned or managed by the City of Portland must meet the requirements of the BES Sewer and Drainage Facilities Design Manual and the technical standards of the City of Portland Standard Construction Specifications.

Before a water-crossing structure or culvert may be placed within a drainageway that provides fish passage or other wildlife benefits, Oregon Department of Fish and Wildlife (ODFW) consultation and approval may be required. ODFW often refers to water crossing design guidelines published by the Washington Department of Fish and Wildlife. Additional requirements may be imposed by state and federal requirements.

A bridge, rather than a culvert, may be required if any of the following apply:

- The active channel is greater than 20 feet wide.
- A roadway width requires a culvert longer than 150 feet.
- Endangered Species Act (ESA) listed fish or other wildlife as identified by the Oregon Department of Fish and Wildlife are present.
- The channel gradient is greater than 6%.
- Woody debris movement occurs frequently.
- There is active channel movement.
- Large animals (e.g., coyote or deer) need wildlife passage.
- A culvert could not achieve hydraulic or hydrologic requirements.

Bridge design would need to consider a variety of items, including, but not limited to, bankfull width, flood plain utilization ratio, stream type, bridge performance, and channel meander migration. Bridge design requirements are not included in the Stormwater Management Manual and should meet state and local building, structural, and transportation requirements.

Design Information

Culverts and other water crossing structures should be designed to safely pass stormwater from the 25-year storm for build-out conditions in the upstream drainage basin without surcharging the inlet by maintaining continuity of flows upstream and downstream. For streams with a Federal Emergency Management Agency designated floodplain, culverts and other water crossing structures should be designed to convey the 100-year flow. Proposed channel crossing structures will require formal engineering calculations and designs. Channels are complex systems that provide critical habitat and convey water, sediment, and woody debris. Crossings have significant impacts on the proper functioning of channels by changing the way water and sediment are conveyed. Culverts should be designed to maintain the geomorphic function of natural channels, protect habitat, provide fish passage, protect water quality and convey flood flows.

Three standard approaches to culvert design are listed below (no-slope, stream simulation, and hydraulic). See Figure B-1 for a summary of criteria to help guide designers toward an appropriate channel crossing structure at the concept and planning stages. Additional analysis will be necessary to determine the correct structure for site conditions.

Figure B-1. Culvert Design Approach Guidance

Design Approach	Channel Width (bankfull width)	Channel Slope	Channel Stability	Culvert Length	Floodplain Utilization Ratio
No-slope culverts	Less than 10 feet	<3%	Stable	<75 ft	<3
Stream Simulation	Less than 15 feet	Any	Moderate or Stable	Require additional analysis for length-width ratio >10	<3
Hydraulic	Additional engineering methods exist for more complicated situations.				

Floodplain utilization rate is defined the flood prone width divided by the bankfull width. Table summarized from Barnard, R. J., J. Johnson, P. Brooks, K. M. Bates, B. Heiner, J. P. Klavas, D.C. Ponder, P.D. Smith, and P. D. Powers (2013), *Water Crossings Design Guidelines*, Washington Department of Fish and Wildlife, Olympia, Washington.

Open Bottom or Natural Culverts (No-Slope and Stream Simulation)

Culverts designed with an open-bottom or natural-bed are designed to mimic the substrate and flow conditions in the natural streambed above and below the culvert. To accomplish this, the culvert alignment, culvert bed grade, and channel bed material should generally be as similar as possible to the adjacent natural streambed. The culvert size is based on geomorphic features and fish passage, sediment transport continuity and flow conveyance are assumed to be achieved by mimicking the natural channel.

Design Approaches

There are two standard design approaches for open-bottom and natural-bed culverts: no-slope and stream simulation. Both design approaches are described below:

No-Slope Culvert Design Approach

The criteria below apply to the No-Slope design (See Figure B-2)

1. The culvert is set at a nearly flat gradient, no more than plus or minus 0.5 percent.
2. The width of the bed inside the culvert (not the culvert span) is greater than or equal to the prevailing bankfull width of the stream in the reach where the culvert is located. The culvert should not constrict the bankfull flow and is expected to maintain streambed material similar to that found in the adjacent channel.

Figure B-2. No-slope schematic diagram showing the four principle components of the design.

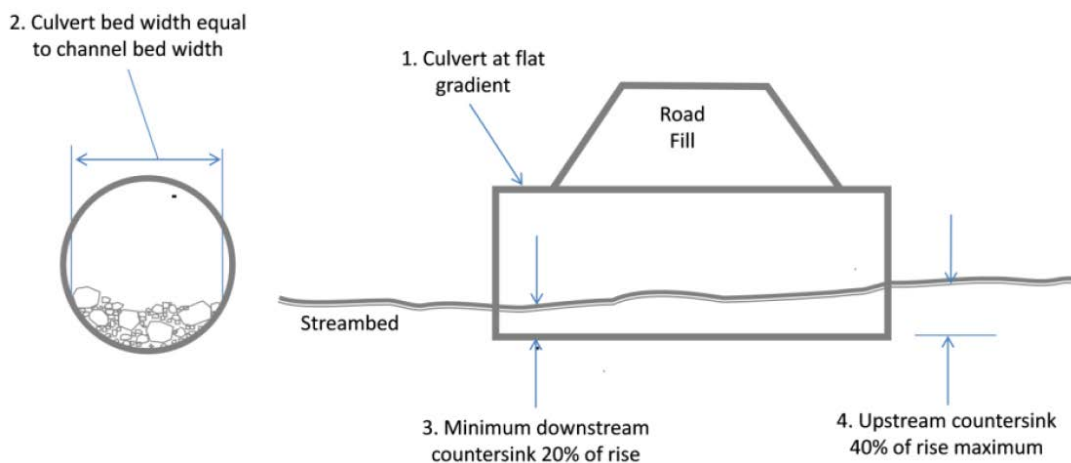

Illustration from Barnard, R. J., J. Johnson, P. Brooks, K. M. Bates, B. Heiner, J. P. Klavas, D.C. Ponder, P.D. Smith, and P. D. Powers (2013), *Water Crossings Design Guidelines*, Washington Department of Fish and Wildlife, Olympia, Washington.

In addition, a no-slope culvert should meet the following design criteria:

- A bed should be placed in the culvert that is composed of material similar to or an improvement of the bed of the adjacent stream.
- Adequate clearance between the culvert bed and crown should be provided to pass expected debris and high flows during flooding events.

[Stream Simulation Design Approach](#)

The culvert shape, dimensions, slope and bed roughness should be designed to provide flood conveyance capacity and fish passage and not result in any further degradation of water quality.

Design Guidance

1. Moderately confined channels.
2. Bankfull width less than 15 feet.
3. Equilibrium stream slope (stable channel).
4. Culvert bed slope should not be greater than 1.25 times the upstream channel's slope
5. Additional analysis for culverts with a length-to-width ratio greater than 10.

Both no-slope and stream simulation designed culverts should take into account the following design criteria:

Horizontal Alignment

Culvert alignment should be established to make the culvert as short as possible while minimizing the skew of the culvert relative to the existing stream channel alignment. Skew between the upstream channel orientation and the culvert inlet increases inlet contraction resulting in turbulence at high flows and a reduction of flood conveyance capacity and sediment transport. In-channel deposition and bank scour often occur upstream of culverts with excess skew. When the culvert is skewed relative to the downstream channel alignment, there is an increased risk of bank erosion near the culvert outlet. When conditions make the ideal alignment impractical, the designer should consider relocation of a portion of the channel or small angle bends with bank stabilization.

Culvert Length

The culvert length should be minimized to reduce channel disturbance. This consideration should be balanced with the need to minimize the skew of the culvert alignment relative to the stream channel as described above.

The maximum culvert length that can provide conveyance capacity, stream power continuity, subcritical flow regime, and fish passage (if required) for any given channel is dependent on stream hydrology and geomorphology (e.g., slope, sediment transport conditions). Culvert length can be minimized by adding headwalls to each end of the culvert, by narrowing the road or by steepening the fill embankments.

Culvert Size

The width of the active stream channel is the stream width that occurs annually at ordinary high water. This width can be determined by measuring the stream's cross-sectional distance between the ordinary high water line (OHWL) on both banks of the stream, or estimated by physical features such as the following:

- A topographic break from vertical bank to flat floodplain.
- A topographic break from steep slope to gentle slope.
- A change in vegetation type.
- A textural change of depositional sediment.
- The elevation below which no fine debris (needles, leaves, cones, seeds) persists.
- A textural change of matrix material between cobbles or rocks.

To the maximum extent practicable, the culvert span should be 1.2 times the active channel plus two feet. At least three typical cross section widths should be used for an average.

The minimum culvert bed width should be calculated as 1.2 times the active stream channel width plus two feet. A span of at least 6 feet is typically necessary to enable channel bed construction within a culvert. For construction and maintenance of the culvert, a minimum effective rise (from the culvert bed to the height of the culvert crown) of 4 feet is recommended. This should allow for the passage of wood and sediment and favor other natural fluvial processes.

Flood Conveyance Design (Hydraulic Analysis)

Demonstrating flood conveyance capacity and performing scour analysis for flood flows is usually required when using hydraulic analysis. This type of analysis must be performed by a registered professional engineer. Acceptable design approaches include:

- Federal Highway Administration Hydraulic Design of Highway Culverts (FHWA 2012)

- Analysis with a hydraulic model such as HEC-RAS

This analysis should provide water surface profiles, energy grade line, bed shear, and velocities through the structure for the applicable design flows.

Culverts should be sized to:

- Convey 25-year design storm flow
- Not cause an increase of more than 1-ft in the 100-year flood elevation under full build-out conditions as per Portland City Code Title 24.50.060
- Culverts in designated floodways should meet the conveyance criteria outlined in Title 24.50

Design Storm

Typically, culverts should be designed to convey the 25-year storm flow through a roadway fill without surcharging the inlet (i.e., water depth shall not exceed the inside height of the culvert crown). If regular high water conveyance is predicted, culverts may need to be designed to convey the 100-year storm flow. If the risk associated with culvert failure is high, a more conservative standard may be required.

In addition, if the culvert is not oversized to convey the 100-year peak flow, a route should be established to safely convey any flow exceeding the 25-year storm without damage to property, endangering human life or public health, or causing significant environmental impact.

Culvert Bed Slope

Culvert bed slope should be set as close as possible to the natural channel gradient extending upstream and downstream of the culvert. For new installations, this is the slope of the existing channel. For replacement culverts, this is the slope of the channel upstream and downstream of the roadway crossing (beyond the extents of any channel scour or bed aggradation created by the culvert that is being replaced). Calculated slope should approximate the average slope of the adjacent streambed from 10 channel widths upstream and downstream of where the new culvert should be placed.

Installing the culvert bed at a slope significantly lower (flatter) than the natural gradient may result in a reduction of stream power and resultant sediment aggradation that reduces conveyance capacity and hinders other natural functions. Installing the culvert bed at a slope significantly higher (steeper) than the natural

gradient may induce instability of the culvert bed material during higher flows. The ratio of the culvert bed slope to the natural channel slope should not exceed 1.25.

The culvert pipe/structure itself may be installed flat or on a slope, depending upon the culvert length and bed slope. For box culverts, the slope of the culvert should be minimized to decrease shear stress between the culvert bottom and the bed material. The depth of channel bed material can vary through the length of a bottomless/open-bottom culvert that is laid flat to create the desired bed slope through the culvert. This typically requires a taller culvert pipe/structure so that the hydraulic opening on the upstream side meets the design criteria. Longer culverts should include some slope in order to maintain embedded depths and inlet capacity.

Culvert Bed Material

A bed should be placed in the culvert that is composed of material similar to or an improvement of the bed of the adjacent stream. The use of grout or any other substrate-binding bed material together is not recommended.

During construction, the small rock, large rock, and fines should be mixed before placing. The final bed surface should be washed gently with water to allow the fines to work into interstitial spaces and provide a good seal, and to demonstrate that this seal has occurred.

Bed material should be sized based on a sieve analysis of the adjacent natural stream channel. The bed material distribution should be well-graded, non-porous and have approximately 5 to 10% fines. Larger material may be used in moderation to assist in grade retention and to provide resting areas for migratory fish. It is not appropriate to compare sediment size estimates with channel reaches that are controlled by large wood, deeply incised, or not in equilibrium.

Vegetated channels should be designed to match expected natural conditions as determined by the reference reach approach. The design should maintain stability and prevent erosion. Analysis using accepted engineering methods should be used including the stable channel design approach included in the Sewer and Drainage Facility Design Manual or other approach.

Scour Analysis and embedded depth

Hydraulic analysis should be performed to ensure structural integrity at high-flows. Scour analysis should be performed to ensure that bed material remains within the culvert during flood flows. The designer may need to include some large oversized key boulders that should remain in place during the 100-year flow and stabilize the bed. The design should take scour analysis into account when determining the bed

material design and proposed embedded depth of countersunk culverts and footings.

Baseflow Channel

The minimum cross-sectional dimensions for the baseflow channel (1 foot wide x 6 inches deep) are based on confining the summer baseflow. The baseflow channel helps to maintain stream power on the bottom leg of the hydrograph, hence transporting the fine-grained materials through the culvert. In addition, the baseflow channel confines low flows and helps to maintain sufficient depths for fish passage during low flow periods.

Woody Debris Transport

Adequate clearance between the culvert bed and crown should be provided to pass expected debris during flooding events. Culverts shall be designed to provide some transport of woody debris. The size of material to pass through a culvert should be selected based on woody material present in the system (considering root-wad diameter for larger pieces) and culvert size constraints. The water depth required to pass (i.e., float the material) should be calculated and accommodated. The culvert rise can be designed so that sufficient water depth and freeboard occurs during a storm in which the material would be mobile.

If it is not feasible to design for wood passage, and frequent accumulations of wood can reasonably be expected in the channel system upstream, the culvert may be vulnerable to blockage with wood mobilized in higher flow events. In these situations, consideration should be given to installing wood trapping measures in the upstream channel. For example, one or more engineered logjams could be installed in the channel upstream of the culvert to trap wood at a targeted location. If the culvert is not sized to effectively convey woody debris, long-term maintenance may be required to periodically remove collected debris in the channel upstream of the culvert and place it downstream of the culvert.

When frequent transport of large woody debris should be provided, a bridge should be considered. While there is no easy way to quantitatively evaluate the frequency of wood transport, considerations should be made for the downstream transport of woody debris when woody debris accumulations are observed in the channel, there is history of culvert plugging in the system, and/or there is a potential for recruitment of wood from a well-vegetated riparian corridor.

Inlet/Outlet Treatment

If the culvert width is less than the upstream or downstream channel width or the skew of the culvert inlet or outlet relative to the stream alignment is significant (not recommended, but sometimes may be necessary), structural protection of the inlet and/or outlet may be necessary. Depending on the size of the channel and the peak flow rates that the culvert should convey, this protection can range from concrete wingwalls to rock armoring or woody debris embedded in a tapered section of the channel bank approaching the upstream culvert entrance. If the channel is actively meandering, large wing walls and/or upstream bank stabilization is strongly recommended, regardless of culvert width.

Grade Control

If the stream channel bed is aggrading (rising) or degrading (incising), grade control structures may be needed up or downstream of the channel crossing. Such instability is indicated by evidence of historical fluctuations in channel bed elevation (e.g., headcuts, channel avulsion, gravel-splay deposits in floodplain). If instability is observed downstream of the road crossing, grade control should be installed below the culvert to prevent the upstream migration of headcuts that could undermine the structure and damage the roadway. If instability is observed upstream of the road crossing, grade control can help to stabilize the reach. Grade control structures can also be used to adjust the gradient of the adjacent channel. Grade control structures should also meet all applicable fish passage requirements.

Hydraulic Design

Under certain circumstances, a closed-bottom culvert sized using only hydraulic analysis may be allowed. Culverts designed under this approach should provide passage of the 25-year flow with no surcharge (additional clearance may be required in larger systems or when debris passage is required). Natural bed material is not required but should demonstrate flow conveyance and should be designed to prevent upstream deposition or downstream scour. This may not be allowed in any locations requiring fish passage and may be used in instances to protect against landslide hazards or along roadside ditches, for example.

Structural Design

Culverts, bridges and all water crossing structures require engineering design and analysis to ensure they are providing adequate structural strength. Structural designs should take into account the strength of underlying soils, soil cover, traffic loads and other design considerations. Typical culvert materials include: metal pipe (arch pipe or closed pipe), pre-cast concrete and cast-in-place concrete. Selection of

the optimal material for a particular site is typically based on cost, site accessibility and construction planning, and structural strength.

Minimum Cover Requirements

Cover requirements vary depending on the culvert material selected:

- All culverts made of metal require soil cover between the top of the culvert barrel and the overlying ground surface or roadway pavement section. The depth of cover over the culvert will vary depending upon the weight of traffic loads or other land use that can be expected atop the culvert.
- Culverts made of reinforced concrete (cast-in-place or pre-cast) can be designed to directly support required traffic loads.

Foundation

The type of foundation necessary depends on the structure selected. A geotechnical engineer should be consulted to determine the adequacy of the underlying soil to support the weight of the structure, adjacent backfill, and the overlying roadway or other overlying land use. The geotechnical engineer's recommendations should be followed to achieve sufficient structural support for long-term success and prevent differential settlement.

Construction Considerations

Construction of open bottom and natural-bed box culverts requires fairly intrusive excavation and local modification of channel conditions at each end of the culvert. There are many considerations that should be addressed for timely completion of construction and prevention of adverse environmental impacts during construction. Prior to construction, in-water work permits should be obtained from multiple state and federal regulatory agencies, including but not limited to, the US Army Corps of Engineers, ODFW, and DSL.

The time and duration of culvert construction should be carefully considered to minimize stream sedimentation, flow interruption, and disturbance of fish during sensitive periods. Generally, construction should be performed during low flow conditions in mid to late summer. For guidance on when in-water construction is allowable in the project area, consult ODFW's [Guidelines for Timing of In-Water Work to Protect Fish and Wildlife Resources](#).

Vegetation removal and brush work should minimize impacts to birds and wildlife, specifically nesting birds, to comply with the [Migratory Bird Treaty Act](#).

Disturbance of the bed and banks should be limited to that necessary to place the structure, embankment protection, and any required channel modification associated with the installation. This should expedite completion of construction and minimize potential for adverse water quality impacts. Project activities should be kept within the regulated work areas only. Equipment should not be allowed to enter any waters of the State or U.S., or the regulated work area except as allowed in permits issued for the project. All disturbed areas associated with culvert or other water crossing structure construction should be replanted with native vegetation to help stabilize soils and slopes; this includes construction access roads, equipment landing pads, and other areas upland of the bed and banks. Untreated areas within the project's work area may trigger upslope erosion and subsequent in-water impacts.

Heavy machinery that produces excessive ground compaction may not be allowed within the drainage reserve during construction. Low ground-pressure vehicles (such as spider hoes or those approved under Environmental Zoning or Greenway Code allowances) may be allowed if the applicant can show adequate soil and vegetation protection during construction and restoration.

B.2 Outfalls

Outfalls are a stormwater conveyance feature that discharge from a stormwater management facility to a stormwater-only system, such as a drainageway, creek, stream or river. Outfalls should be designed and constructed to provide flow conveyance and should minimize impacts to stream channels and watersheds. Outfall design and construction should prevent and reduce erosive conditions and protect the stability of shorelines, channels, and ravine slopes.

Additional Design Information

Outfalls owned or managed by the City of Portland must meet the requirements of the BES Sewer and Drainage Facilities Manual and the technical standards of the City of Portland Standard Construction Specifications.

If the conveyance channel in which the outfall is used has fish passage or other wildlife requirements, Oregon Department of Fish and Wildlife (ODFW) consultation and approval may be required. Additional requirements may be imposed by state and federal agencies.

Outfalls subject to Portland City Code Title 33 requirements (33.430 Environmental Zones) must meet the standards for stormwater outfalls of City Code Section 33.430.180 or be approved through environmental review.

The following outfall design criteria are for outfalls smaller than 36 inches in width. Three types of outfalls are addressed below in prioritized order:

- Open channel outfalls: stormwater is discharged via an open channel (such as a ditch) to a stream, drainageway, or another open channel. Open channel outfalls are good options for sites with existing ditches or channels.
- Upland dispersion: stormwater is spread out over an area outside of the riparian zone and higher in elevation than the receiving stream, drainageway, or open channel. Sometimes referred to as level spreading. Upland dispersion is a good option for sites where stormwater currently infiltrates.
- Piped outfalls: stormwater is discharged from a piped conduit (typically concrete, metal or plastic) to a stream, drainageway or open channel. A piped outfall is often used at the terminus of a storm sewer piped network or to convey water down slope.

Design Information

Outfall design and selection is dependent upon local conveyance and energy dissipation requirements. The size of the outfall is determined based on Oregon plumbing code requirements and the design storm size (typically, the 25-year design storm). Configuration and placement of the outfall should be designed based on site conditions, such as site slopes, drainage basin size, fish passage status, soil erodibility, receiving channel conditions, slope stability, and existing vegetation. Drainageways may have steep slopes or banks and may have unstable landforms (i.e. slump). Geotechnical investigation to determine the stability of the stream or river bank, as reviewed and approved by BES or BDS, may be required prior to approval.

The outfall should be oriented at no less than a 30 degree angle from a perpendicular alignment with the receiving channel; with the confluence of flow oriented in the downstream direction.

Outfalls should be located above the downstream mean low water level. Endwalls or flared end sections may be required for exposed outfall pipes greater than 12 inches in diameter. Publicly accessible outfalls greater than 18 inches in diameter should include grated protection.

Erosion and Scour Control

The outfall and the construction area should be designed, constructed and maintained to reduce erosion. Erosion can result when the dispersed flow passes over sparsely vegetated ground or bare soil and when the shear stress of the flowing water exceeds the shear stress at which the soil lining the outfall channel or receiving waterway is stable (the critical shear stress). If the construction of an outfall results in bare soil, long-term erosion control should be provided through vegetation coverage and best management practices as required by the Erosion Control and Sedimentation Manual (Administrative Rule ENB-4.10). Such practices may include a natural-fiber erosion control blanket (such as jute, coir, or excelsior) to provide soil stabilization while the vegetation matures and native vegetation becomes established. Thick vegetation cover is critical to effective dispersion and infiltration of stormwater.

Protection from erosion can be provided by several techniques. A few of these techniques are listed below.

- rock lining (large riprap or smaller quarry spalls, or streambed boulders;

- geotextile fabric lining;
- low-rise check dams spanning the outfall channel;
- plantings on the channel banks; and/or
- woody structures installed in the drainageway channel bank.

The design should also minimize flow velocities and dissipate energy at the outfall to the extent possible, thereby decreasing the potential for erosion and scour in the flow path to the adjacent stream, drainageway, or open channel. In general, stormwater conveyance systems should be designed to reduce flow velocity throughout the length of the network, not just at the outfall. Erosion control techniques such as rock, should not impede fish passage within the receiving water.

Outfall Discharge Protection and Energy Dissipation

Protection of outfalls at the point of discharge to a drainageway, stream or other waterway is important to protect channel bank stability and reduce erosion. Depending on the flow velocity and existing site conditions, a variety of natural materials can be used to disperse energy and prevent erosion. While rock is a traditionally used material, the use of large woody debris is preferred if feasible. Large woody debris (larger than 12" diameter) from long-lived species such as Western redcedar or sitka spruce is preferred. Large wood can be engineered to deflect flow and dissipate energy as effectively as large rock, and provides additional habitat benefits to aquatic and terrestrial ecosystem processes. Logs may be stacked to form outfall wing walls or to shore up banks on either side of an outfall's confluence with a shoreline. It may also be used to build structural beds on stream banks or slopes where native riparian vegetation should be planted post-construction. Incorporating large wood into outfall designs may also contribute to project impact mitigation, particularly if the project takes place in an area bearing ESA-listed fish or wildlife.

The use of large, rounded boulders at the outfall outlet may be useful to deflect debris moving downstream away from the outfall. With the use of the proper size and gradation, rocks provide energy dissipation as well as protection against soil erosion. All rock protection areas should be interplanted with willow stakes or other appropriate riparian vegetation to increase slope stability, reduce erosion, provide shading and other habitat functions, and improve aesthetics. See Figure B-3 for information on using rock for outfall protection.

Figure B-3. Rock Protection at Outfalls

Outfall Diameter	Discharge Velocity at Design Flow	Average Stone Size	Depth	Width	Length	Height
2 inch		1 inch	2 inch	12 inch	24 inch	
4 inch		2 inch	4 inch	24 inch	36 inch	
6 inch		4 inch	6 inch	36 inch	48 inch	
>6 inch	0-5 feet per second	Riprap	2 x max stone size	Diameter + 6 feet	As calculated	Crown + 1 foot
	6-10 feet per second	Riprap	2 x max stone size	Greater of (diameter + 6 feet) or (3x diameter)	As calculated	Crown + 1 foot

Riprap size shall be calculated as $ds = 0.25 * (V/g)(6'' \text{ minimum})$, where ds = rip rap size, V = average velocity (ft/s) and $g=32.2 \text{ ft/s}^2$.

High velocity flows have significant kinetic energy, which can cause extensive erosion and scour at an outfall and/or receiving waterway. When flow velocity is high at an outfall, the energy should be dissipated and erosion protection should be in place to protect against scour. The design of an energy dissipation device is unique to the site; both the engineer designing the system and the reviewer of the design should consider that the device may not match the specifications above. However, as long as it can be proven to both dissipate energy and protect against erosion and scour, it can be considered acceptable.

Energy dissipation techniques include:

- rock outfalls with vegetation incorporated;
- pipe tee diffusion structures; and
- non-rock dissipaters that are shaped with soils, vegetation, berms, and woody debris are encouraged.

Energy dissipation structures (stilling basins, drop pools, hydraulic jump basins, baffled aprons, bucket aprons should be engineered) may be required where velocities are greater than 5 feet per second.

Open Channel Outfalls

To use an open channel outfall, the following conditions should be met:

- The soils through which the outfall channel is constructed should be stabilized through approved erosion control measures and may require an official geotechnical report.
- The longitudinal slope (in the direction of flow) of the outfall channel should be less than 20 percent.
- Side slopes shall be a maximum of 3:1. Steeper side slopes may be allowed for channels with rock protection.
- Freeboard should allow at least 6 inches for the 25-year flow.
- The open channel should not pose safety risks at design flow depth.
- Fish passage should be prohibited into any stormwater quality facility through an open channel outfall.

Channel Depth and Width

The primary concerns where an open channel outfall merges with a wider and deeper channel are prevention of erosion at the confluence of the outfall channel and the receiving channel, and stabilization of the outfall channel. The bottom (invert) of the open channel outfall should be at the same elevation as the bottom of the receiving channel, to avoid spilling of water down the bank of the receiving channel that can cause erosion of the bank or bed of the receiving channel. There should be 6 to 12 inches of freeboard depth above the design storm water surface elevation in an open drainage channel.

Angle of Discharge at Confluence with Drainageway Channel

The open channel outfall should be oriented at no less than a 30-degree angle from a perpendicular alignment with the receiving channel, with the confluence of flow oriented in the downstream direction.

Plantings

Native vegetation should be incorporated into the design of an open channel outfall. In most cases involving planting, the use of an erosion control blanket over the bare soil is recommended until the vegetation is fully established. Vegetation should be fully established at 90% cover within one year of planting. Reference the [Portland Plant List](#) for appropriate vegetation. See Title 11 Tree Code for tree requirements relating to development situations.

Grade and Erosion Control

To minimize erosion and scour, the outfall should be designed to be at the same elevation as the bottom of the open channel and the bottom of the receiving waterway. Where the outfall channel slope drops steeply to meet the receiving drainageway channel, one or more grade control structures (larger than typical check dams) may be required to create a step-pool sequence within the open channel outfall. Steep (greater than 20 percent slope) elevation drops of greater than 1 foot should be avoided through use of properly designed and installed grade controls, particularly if upstream fish passage is a consideration. Outfalls on grades over 20% may be required to pipe down slope to the receiving waterway. Appropriate grade control measures depend upon the outfall channel, the receiving waterway, and the site characteristics.

If the receiving drainageway channel is deeply incised near the outfall, grade control structures may be needed within the drainageway channel for a reasonable distance downstream of the outfall point to prevent the outfall discharges from worsening the incision problem. If a project site appears to need grade control structures for channel stability, a stream restoration design professional should be consulted early in the project design.

If check dams are used to slow velocities in the open channel outfall, a minimum of three check dams are recommended. They should be made of wood or rock, and should be keyed into the open channel bed and banks to prevent the dam from being displaced or bypassed during high flows. Where rock is used, the rock should be placed by hand or mechanically, rather than dumped from a truck. Check dams are a good choice for steep outfall channels if channel lining is impracticable. Check dams are not usually necessary in low-gradient (less than 1 percent channel slope) reaches.

Upland Dispersion

Dispersion of concentrated stormwater flows is often a good choice for discharges to long slopes, ravines, riparian areas, and other natural areas where erosion could readily occur otherwise. Where soil conditions are appropriate, this method enables stormwater to be used to support habitat functions while also adding stormwater attenuation benefits through uptake by vegetation, decreased flow velocities, and allowing infiltration. Effective dispersion occurs when concentrated flows are converted to sheet flow. The primary concerns for effective dispersion design are stable slopes, a suitably-sized vegetated flowpath downslope of the dispersal location, prevention of erosion caused by the dispersed flow, and selection of

plantings that are suited to the hydrologic regime that should be created by the flow dispersion.

To use upland dispersion, the following conditions should be met:

- Stormwater discharges are considered low flow (100-year flow less than 2 cfs).
- The slope(s) onto which the runoff will be dispersed should be stable.
- The slope(s) onto which runoff will be dispersed should have a gradient of 20 percent or less. Otherwise, evaluation by a geotechnical engineer or qualified geologist and approval by the City of Portland Bureau of Development Services may be required.
- There should be no existing concentrated surface discharge (channels or ditches) on the site.
- No drinking water wells, septic systems, or springs used for drinking water may lie within 100 feet of the proposed dispersion site.
- A vegetated flow path of at least 50 feet should be accommodated from the proposed dispersion location to the nearest property line, structure, environmental zone, or steep slope (greater than 40 percent).

Vegetated Area Requirements

Native plants are required in any temporary disturbance areas in drainage reserves. For plant recommendations, see the [Portland Plant List](#). Choose plants appropriate for the native plant community type as described in the Portland Plant List. Vegetation should be planted in quantities per Figure B-4 and should reach 90 percent vegetation cover within one year. See Title 11 Tree Code for tree requirements relating to development situations and City Code Title 33, the for vegetation requirements related to applicable environmental zoning. For public natural areas with approved master plans or management plans, vegetation requirements may vary.

Figure B-4. Vegetation density for restoration of outfall temporary disturbance areas

Number of Plants	Vegetation Type	Per square feet	Size	Spacing density (on center)
2	Trees	100	6' min height or 1 ½" caliper	Per plan
10	Shrubs	100	1 gallon	Per plan
70	Herbaceous plants	100	4" pots	12"
240	Herbaceous plants	100	Plugs	6"

Sizing and siting guidance

A flow dispersal trench can be used to provide upland dispersion, where direct discharge from a storm drain or culvert infiltrates or percolates through a wide gravel-filled trench before it spreads out and continues onto existing soil and vegetation. The design criteria for a single flow dispersal trench include:

- Discharge points with up to 0.2 cfs discharge for the peak 100-year flow may use rock pads or dispersion trenches to disperse flows.
- Piped discharge points with between 0.2 and 0.5 cfs discharge for the 100-year peak flow should use only dispersion trenches to disperse flows.
- Dispersion trenches should be a minimum of 2 feet wide by 2 feet deep in section, 50 feet in length; filled with ¾ - 1½ inch washed drain rock; and provided with a level notched grade board.
- Manifolds may be used to split flows up to 2 cfs discharge for the 100-year peak flow between four trenches (maximum).
- Multiple dispersion trenches should have a minimum spacing of 50 feet.
- If the 100-year peak flow at the outfall is greater than 2 cfs, dispersion is not an option for the site.

Piped Outfall

On slopes over 20%, it may be difficult to route stormwater through an open channel or disperse upland without causing severe erosion. In such situations, it may be appropriate to use a piped outfall system. To use a piped outfall, the following conditions should be met:

- The soil, slope, or space requirements of an open channel or upland dispersion outfall cannot be met.
- Hand trenching should be provided where runoff will pass over erodible soils where slopes have a gradient of 15 percent or steeper.
- For slopes steeper than 40 percent, the pipe should be installed on the ground surface to minimize disturbance of what could be an unstable slope.

Construction Considerations

Every outfall project is unique and brings with it specific considerations and requirements necessary to protect watershed function and public health and safety. Please note that these guidelines describe only some of the available construction techniques and that others may be appropriate in certain situations.

Construction in and adjacent to streams that provide habitat for fish should adhere to prescribed periods for in-water work, as defined in the Oregon Department of Fish and Wildlife [Guidelines for Timing of In-Water Work to Protect Fish and Wildlife Resources](#). Vegetation removal and brush work should minimize impacts to birds and wildlife, specifically nesting birds, to comply with the U.S. Fish and Wildlife Service's regulatory [Migratory Bird Treaty Act](#).

Heavy equipment and machinery should be kept out of the receiving waterway and off of the banks. Project activities should be kept within the regulated work areas only. Channel beds and banks are typically in a delicate state of equilibrium and can easily be damaged by the action and forces of large earth-moving machinery. Equipment operations within the waterway can cause the release of sediment and disrupt the natural layering and armoring of particles on the channel bed. Out of the waterway, excessive compaction of native soils can slow or limit the propagation of beneficial vegetation, or increase the erosive nature of hillslopes and create conditions conducive to sediment runoff into the conveyance channel. Low ground-pressure vehicles (such as spider hoes or those approved under Environmental Zoning or Greenway Code allowances) may be allowed if the applicant can show adequate soil and vegetation protection during construction and restoration.

For open channel outfalls, the new channel excavation should be completed and stabilized before making the connection to the receiving drainageway. This should minimize the amount of time that disturbance occurs in the receiving drainageway while also enabling the downstream end of the excavated area to serve as a temporary sediment trap for downstream water quality protection. A plug of native soil or other approved equivalent should be retained between the outfall channel excavation and the receiving drainageway until the connection is ready to be made. If runoff or other discharge will occur in the area where a new energy dissipater or open channel outfall is to be constructed, flow bypass or other forms of dewatering should be accomplished to enable construction in relatively dry conditions.

B.3. Reference Material

Culvert Design

Portland Sewer and Drainage Facilities Design Manual (2007 w 2011 Errata)

<http://www.portlandoregon.gov/bes/article/360710>

Oregon Department of Transportation, Hydraulics Manual (2014)

http://www.oregon.gov/ODOT/HWY/GEOENVIRONMENTAL/pages/hyd_manual_info.aspx#Hydraulics_Manual

Federal Highway Administration, Hydraulic Design of Highway Culverts (2012)

<http://www.fhwa.dot.gov/engineering/hydraulics/pubs/12026/hif12026.pdf>

United States Department of Agriculture, Forest Service; Stream Simulation Design for Culverts (2015)

http://www.stream.fs.fed.us/fishxing/aop_pdfs.html

United States Army Corps of Engineers, Conduits, Culverts and Pipes (1998)

http://www.publications.usace.army.mil/Portals/76/Publications/EngineerManuals/EM_1110-2-2902.pdf

Washington Department of Fish and Wildlife, Implementation and Effectiveness Monitoring of Hydraulic Structures (2015)

<http://wdfw.wa.gov/publications/01746/wdfw01746.pdf>

Washington Department of Fish and Wildlife, Water Crossing Design Guidelines (2013)

<http://wdfw.wa.gov/publications/01501/wdfw01501.pdf>

Washington Department of Fish and Wildlife, Stream Habitat Restoration Guidelines (2012)

<http://wdfw.wa.gov/publications/01374/wdfw01374.pdf>

Stream Simulation Design for Culverts

http://www.stream.fs.fed.us/fishxing/aop_pdfs.html

Fish Passage Design

National Oceanic and Atmospheric Administration, Guidelines for Salmonid Passage at Stream Crossings (2001)

http://www.westcoast.fisheries.noaa.gov/publications/hydropower/fish_passage_at_stream_crossings_guidance.pdf

National Oceanic and Atmospheric Administration, Comparing Fish Passage Opportunities (2014)

http://h2odesigns.com/wp-content/uploads/2014/12/NMFS_FishPassageWindowFinalReport_2014.pdf

Oregon Requirements for Fish Passage

Oregon Administrative Rules, Chapter 635-412-0005, Fish Passage:

http://arcweb.sos.state.or.us/pages/rules/oars_600/oar_635/635_412.html

Oregon Department of Fish and Wildlife, Fish Passage Website

<http://www.dfw.state.or.us/fish/passage/>

Oregon Department of Fish and Wildlife, Fish Passage Criteria (2004)

http://www.dfw.state.or.us/agency/commission/minutes/05/Nov/F_4_ODFW%20Fi sh%20Passage%20Criteria%20-%202004.pdf

Other Resources

Flanagan, S. A. (2004). Woody debris transport through low-order stream channels of Northwest California -- implications for road-stream crossing failure. Master's Thesis, Humboldt State University.

Grant, G. E., R. J. Swanson, et al. (1990). "Pattern and origin of stepped-bed morphology in high-gradient streams, Western Cascades, Oregon." Geological Society of America Bulletin 102.

Harrelson, C. C., C. L. Rawlins, et al., Eds. (1994). Stream Channel Reference Sites: an illustrated guide to field technique. Fort Collins, CO, U.S. Dept. of Agriculture, Forest Service, Rocky Mountain forest and Range Experiment Station.

Heiner, B. A. (1991). Hydraulic analysis and modeling of fish habitat structures. American Fisheries Society 10.

Khatua, K. K., K. C. Patra, et al. (2010). Meandering effect for evaluation of roughness coefficients in open channel flow. Conference on Advances in Fluid Mechanics, Algarve, Portugal.

Lagasse, P. F., W. J. Spitz, et al. (2004). Handbook for predicting stream meander migration, Report 533. National Cooperative Highway Research Program. Washington D. C, Transportation Research Board.

Montgomery, D. R. and J. M. Buffington (1998). Channel Processes, Classification and Response. River Ecology and Management. N. a. Bilby. New York, Springer.

Pleus, A. E., and D. Schuett-Hames, et al. (1998). Method manual for the reference point survey, Prepared for the Washington State Department of Natural Resources under the Timber, Fish, and Wildlife Agreement.

Rosgen, D. L. (1994). "A classification of natural rivers." Catena 22.

Rosgen, D., Ed. (1996). Applied River Morphology. Pagosa Springs, CO, Wildland Hydrology.

Appendix C: Resources and References

This appendix provides references for City program and regulations relating to the design, construction, permitting and maintenance of stormwater management and conveyance facilities. It also provide information on non-City programs and design information that may be helpful in design of stormwater management and conveyance facilities. It consists of the following sections:

C.1. Stormwater Management Manual Contact Information	2
C.2. Permitting and Development Review.....	2
C.3. City Codes	3
C.4. City of Portland Resources.....	4
C.4.1. City Design Resources.....	4
C.4.2. City Programs and Bureaus.....	5
C.5. Site Evaluation Maps	6
C.6. Additional Resources	7
C.6.1. Outside Design Resources	7
C.6.2. Outside Programmatic Resources	8

C.1. Stormwater Management Manual Contact Information

Stormwater Management Manual website:

<http://www.portlandoregon.gov/bes/swmm>

To request more information on development standards within the Stormwater Management Manual, write to: BESSTormManual@portlandoregon.gov

Stormwater Presumptive Approach Calculator (PAC)

<https://www.portlandoregon.gov/bes/pac/>

C.2. Permitting and Development Review

Development Services Center (DSC)

Provides expertise and services for all permitting needs and processes. Specific services are listed below.

1900 SW 4th Avenue, 1st Floor

Portland, OR 97201

For hours and availability, visit or call:

<http://www.portlandoregon.gov/bds/34154>

- Permitting Services (503) 823-7310
- Planning and Zoning (Zoning questions) (503) 823-7526
- Plumbing, Electrical, Mechanical, Sign Permits (503) 823-7363
- Resource/Records (503) 823-7660
- Permit Status via Voicemail (503) 823-7000 (4)
- Stormwater facility inspection: (503) 823-7000 (1) Request #487

Bureau of Environmental Services, Development Review Hotline

For questions related to project or site-specific development proposals, including guidance on submittal requirements or required inspections.

(503) 823-7761

Bureau of Development Services (BDS) Early Assistance Appointments

Services are available prior to submittal of a land use review or building permit application. These services are intended to provide useful feedback for projects ranging from relatively simple to very large and complex.

Questions: (503) 823-7526

Application form: <http://www.portlandoregon.gov/bds/36648>

Application Submittal: Early assistance appointment request forms should be submitted to the Development Services Center

Public Works Permitting Process

For information on improvements in the public right of way.

<http://www.portlandoregon.gov/53147>

Site Development Permits

Site development permits are issued for work such as clearing, grading, tree cutting, landslide repair, private streets and groundwork related to new subdivisions, where no building or structure is altered, moved or constructed.

(503) 823-6892

<http://www.portlandoregon.gov/bds/36670>

C.3. City Codes

Title 10: Erosion and Sediment Control

<http://www.portlandoregon.gov/citycode/28175?>

Title 11: Trees

<http://www.portlandoregon.gov/auditor/index.cfm?c=66002&>

Title 17: Public Improvements

<http://www.portlandoregon.gov/citycode/28181?>

Title 21: Water

<http://www.portlandoregon.gov/citycode/?c=28185>

Title 24: Building Regulations

<http://www.portlandoregon.gov/citycode/28188?>

Title 29.30.170 Plumbing

<http://www.portlandoregon.gov/citycode/?c=28732&a=18206>

Title 33: Planning and Zoning

<http://www.portlandoregon.gov/citycode/28197?>

C.4. City of Portland Resources

City resources are available for design guidance as well as resources for programmatic support and information.

C.4.1. City Design Resources

BES Auto CAD Files

<http://www.portlandoregon.gov/bes/53917>

Bird Friendly Design

Guidance on practical design approaches to reduce risks to birds, with a focus on exterior glass and lighting design

<http://www.portlandoregon.gov/bds/article/408796>

City of Portland Standard Details and Drawings

<http://www.portlandoregon.gov/transportation/50383>

City of Portland Standard Construction Specifications

<http://www.portlandoregon.gov/transportation/40032>

Erosion and Sediment Control Manual

<http://www.portlandoregon.gov/bes/article/474129>

Pervious Paving Resources

Provides (BDS) administrative rules on private streets including land use submittal requirements and design and construction requirements.

<https://www.portlandoregon.gov/bds/article/311179>

Portland Plant List

Contains a list of Portland's approved native plants and nuisance plants. Nuisance plants are prohibited from being planted and native plants are required in certain environmental zones and drainage reserves.

<https://www.portlandoregon.gov/bes/article/473164>

Rainwater Harvesting Resources

[Rainwater Harvesting Code Guide](#)

Portland's code guide for installing rainwater harvesting systems.

<http://www.portlandonline.com/shared/cfm/image.cfm?id=68621>.

[Rainwater Harvesting Resource Guide](#)

This factsheet provides information on the benefits of rainwater harvesting and the various city bureaus that are involved in installing a rainwater harvesting system.

<http://www.portlandoregon.gov/water/article/278777>

Sewer and Drainage Facilities Design Manual

<http://www.portlandoregon.gov/bes/article/360710>

Transportation Design and Construction Standards and Documents

Improvements in the public right-of-way must also meet design and construction standards for transportation elements.

<https://www.portlandoregon.gov/transportation/40032>

Water Valves Hydrants and Assemblies

<https://www.portlandoregon.gov/transportation/article/255439>

C.4.2. City Programs and Bureaus

Clean River Rewards – Stormwater Discount Program

Information on Portland's stormwater utility discount program. Property owners can receive up to a 100% discount on on-site stormwater management charges.

(503) 823-1371

<http://www.portlandoregon.gov/bes/41976>

Columbia South Shore Well Field Wellhead Protection Program

Information on the groundwater protection program, regulations, area map and technical assistance.

<http://www.portlandoregon.gov/water/29890>

Combined Sewer Overflow (CSO) Program

Information on Portland's 20 year combined sewer overflow program that was completed in 2011.

<http://www.portlandoregon.gov/bes/31030>

Ecoroof Resources

Information on a variety of ecoroof resources in the city of Portland including project examples, technical guidance and how to find an ecoroof professional.

<http://www.portlandoregon.gov/bes/44422>

Green Street Steward Program

Information on how community members can participate in the care and maintenance of Portland's green streets.

<http://www.portlandoregon.gov/bes/52501>

Maintenance Inspection Program

The City of Portland has a program to inspect stormwater management facilities installed on private property and provide property owners with the Technical Assistance they need to ensure that stormwater management facilities are functioning as intended.

<http://www.portlandoregon.gov/bes/45464>

Revegetation Program

The City of Portland has a program that designs, plants, inspects and maintains stormwater management facilities in the public right of way and on public property.

<http://www.portlandoregon.gov/bes/article/394076>

Urban Forestry

Portland Parks & Recreation Urban Forestry's Department manages Portland's forest infrastructure. Information on permits for planting, pruning, and removal of all public and some private trees. The site also provides information on 24 hour tree emergency response.

(503) 823-4489

<http://www.portlandoregon.gov/parks/38294>

C.5. Site Evaluation Maps

Portland Maps

This site includes public storm and sewer utility information. Inquirers can search by address to find detailed information about properties. Sewer and environmental information is located under the utilities tab. Tax lot information is located under the assessor and assessor detail tab.

<http://www.portlandmaps.com>

Soil Survey of Multnomah County

Soil Conservation Service, 1982

This document contains soil survey data and soil property data for Multnomah County.

http://www.nrcs.usda.gov/Internet/FSE_MANUSCRIPTS/oregon/OR051/0/or051_text.pdf

C.6. Additional Resources

Additional programmatic and design resources are available through other states and jurisdictions.

C.6.1. Outside Design Resources

East Multnomah Soil and Water Conservation District – Rain Garden design and construction

<http://emswcd.org/in-your-yard/rain-gardens/>

Environmental Protection Agency National Stormwater Calculator

<http://www.epa.gov/water-research/national-stormwater-calculator>

King County Surface Water Management

King County, Washington, “Surface Water Design Manual”, originally published in 1990 (effective January 24, 2005)

<http://www.kingcounty.gov/environment/water-and-land/stormwater/documents/surface-water-design-manual.aspx>

Oregon Specialty Plumbing Code 2011

<http://www.iapmo.org/Pages/2011OregonPlumbingSpecialtyCode.aspx>

Oregon State University, Sea Grant, Oregon Rain Garden Guide

<http://seagrants.oregonstate.edu/sppubs/oregon-rain-garden-guide>

Pervious Paving Resources

ODOT 2015 Standard Specifications PART 00700 - WEARING SURFACES:

http://www.oregon.gov/ODOT/HWY/SPECS/pages/2015_Standard_Specifications.aspx

City of Tacoma permeable paving specifications

<http://www.cityoftacoma.org/cms/one.aspx?objectId=81563>

Pervious Asphalt

National Asphalt Paving Association, [Porous Asphalt Pavements for Stormwater Management](#):

<http://store.asphaltpavement.org/index.php?productID=759>

Pervious Concrete

National Ready Mix Concrete Association:

<http://www.perviouspavement.org/>

Pervious Pavers

Interlocking Concrete Pavement Institute:

<http://www.icpi.org/paving-systems/permeable-pavers>

Port of Portland - Stormwater Design Standards Manual

https://www.portofportland.com/PDFPOP/Stormwater_Design_Standards_Manual.pdf

Rainwater harvesting Resources

Building Codes Division Oregon Smart Guide

<http://www.bcd.oregon.gov/pdf/3660.pdf>

For information from the Oregon Specialty Plumbing Code, refer to the website:

<http://www.cbs.state.or.us/external/bcd/programs/plumbing/2008opsc.html>

Seattle Washington Stormwater Code

<http://www.seattle.gov/dpd/codesrules/codes/stormwater/>

Washington State Department of Ecology

Stormwater Management Manual for Western Washington

<http://www.ecy.wa.gov/programs/wq/stormwater/manual.html>

C.6.2. Outside Programmatic Resources

Clean Water Services

Private Water Quality Facility Management Program

<http://www.cleanwaterservices.org/PermitCenter/Inspections/privatewaterqualityfacility.aspx>

Metro

Portland's regional form of government that oversees regional land use planning, research, natural areas and solid waste and recycling.

<http://www.metro-region.org/>

Multnomah County Drainage District

The Multnomah County Drainage District prevents flooding through the management of levees, pump stations and drainageways, facilitates recreation within drainage district facilities and maintains habitat friendly environments along the Columbia River and Columbia Slough.

<http://www.mccd.org/>

Oregon Department of Environmental Quality (DEQ)

DEQ is Oregon's state agency that regulates the protection of Oregon's land, water and air quality.

<http://www.oregon.gov/DEQ/Pages/index.aspx>

Oregon Department of Environmental Quality (DEQ), Underground Injection Control Program (UIC)

<http://www.deq.state.or.us/wg/uic/uic.htm>

Oregon Department of State Lands

Provides information on regulations associated with activities within waters of the state.

<http://www.oregon.gov/DSL/pages/index.aspx>

Oregon Environmental Council – Low Impact Development Guidance Template

A guidance manual that cities and counties throughout Western Oregon can use to use to reduce stormwater runoff, prevent flooding, and improve the health of our rivers, lakes and streams

<http://oeconline.org/lidmanual/>

Oregon Environmental Council - Stormwater Solutions Report

A report developed to recommend strategies (including policies, projects, and programs) that will reduce stormwater impacts in Oregon's urban areas.

<http://stage.oeconline.org/wp/wp-content/uploads/2014/11/Stormwater-Solutions-Report.pdf>

Salmon Safe Certification

A guide for site developers and designers interested in developing environmentally innovative projects that help restore our urban watersheds

<https://www.salmonsafe.org/getcertified/development>

U.S. Green Building Council

The US Green Building Council helps advance buildings are designed, constructed and operated through Leadership in Energy and Environmental Design, (LEED). LEED, or is a certification program for buildings and communities that guides their design, construction, operations and maintenance toward sustainability

<http://www.usgbc.org/>

West Multnomah Soil and Water Conservation District – Healthy Stream Program

The Healthy Streams Program provides full funding, project planning and technical assistance to landowners for streamside restoration to improve water quality, wildlife habitat and the condition of the land.

<https://wmswcd.org/programs/healthy-streams/>



The City of Portland complies with all non-discrimination laws including Title VI (Civil Rights) and Title II (ADA). To request a translation, accommodation or additional information, please call 503-823-7740, or use City TTY 503-823-6868, or Oregon Relay Service: 711.