

PROPOSED DRAFT

Date: 1.29.2020

UPDATED

RIVER DISTRICT RIGHT-OF-WAY STANDARDS

Framework Plans
Performance Criteria
Design Standards

**Selected Pages for
Design Commission Briefing**



January 2020
City of Portland
Bureau of Transportation

TABLE OF CONTENTS

INTRODUCTION

0.0	Introduction to 2020 Update.....	1
0.1	How to Use this Document	3
0.2	Background.....	4
0.3	Purpose.....	6
0.4	Action Items.....	7

FRAMEWORK PLANS

1.0	Framework Plans: Policy.....	9
1.1	Framework Plans; Right-of-Way Design.....	21
1.2	Street Widths: Right-of-Way.....	22
1.3	Typical River District Streets.....	23
1.4	Special Function River District Streets.....	25
1.5	Street Trees.....	37
1.6	Street Lighting.....	38

PERFORMANCE CRITERIA

2.1	Vehicular Criteria	39
2.2	Bicycle Criteria.....	42
2.3	Transit Criteria	44
2.4	Utilities Criteria.....	47
2.5	Pedestrian Criteria.....	48
2.6	Street Lighting Criteria.....	53
2.7	Street Furniture Criteria.....	54
2.8	Street Tree Criteria.....	55
2.9	Special Features Criteria.....	58
2.10	Pettygrove Street Criteria.....	59
2.11	Johnson and Park Street Criteria	62
2.12	Green Loop Criteria	64
2.13	Constructibility and Maintenance	67
2.14	Stormwater Management	68

DESIGN STANDARDS

3.0	Design Standards.....	69
3.1	Sidewalks Diagrammed by Zone	69
3.2	Street Pavements: CIP Concrete or Asphaltic Concrete Paving	91
3.3	Elevated Roadway Structures.....	91
3.4	Street Lighting.....	91
3.5	Landscape.....	91
3.6	Special Function Streets	92

INTRODUCTION

The resulting updated document retains most elements of the original, updates the street network to reflect new streets, both built and planned, and amends selected performance criteria and standards to reflect changes in City policy and community issues.

River District Street Network

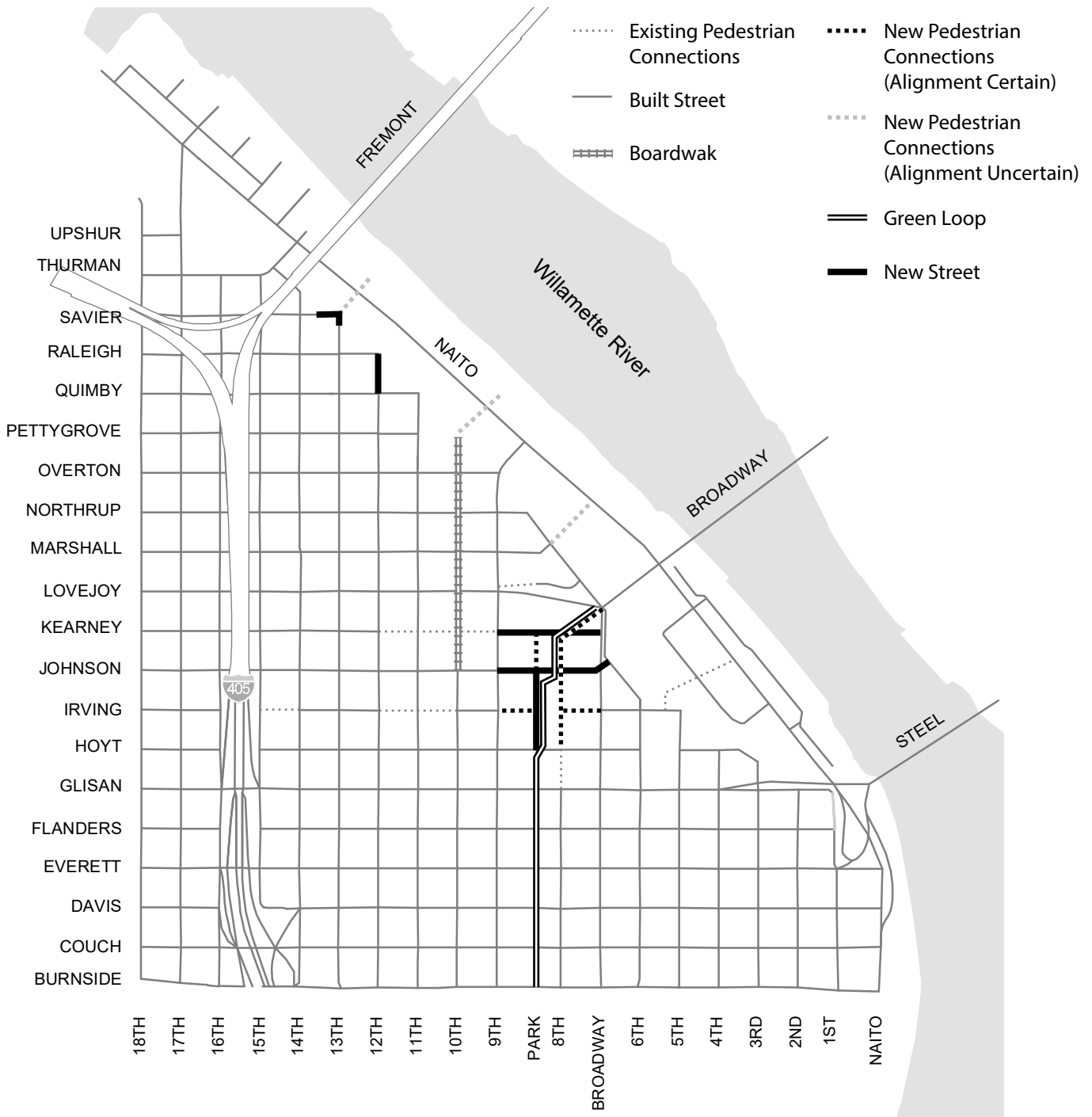

1.2 STREET WIDTHS: RIGHT-OF-WAY

The predominant existing right-of-way pattern is 60 feet throughout the River District. The exception to this norm are several of the Special Function streets where either wider right-of-way exist or will be provided or where new right-of-way will be established as streets are extended.

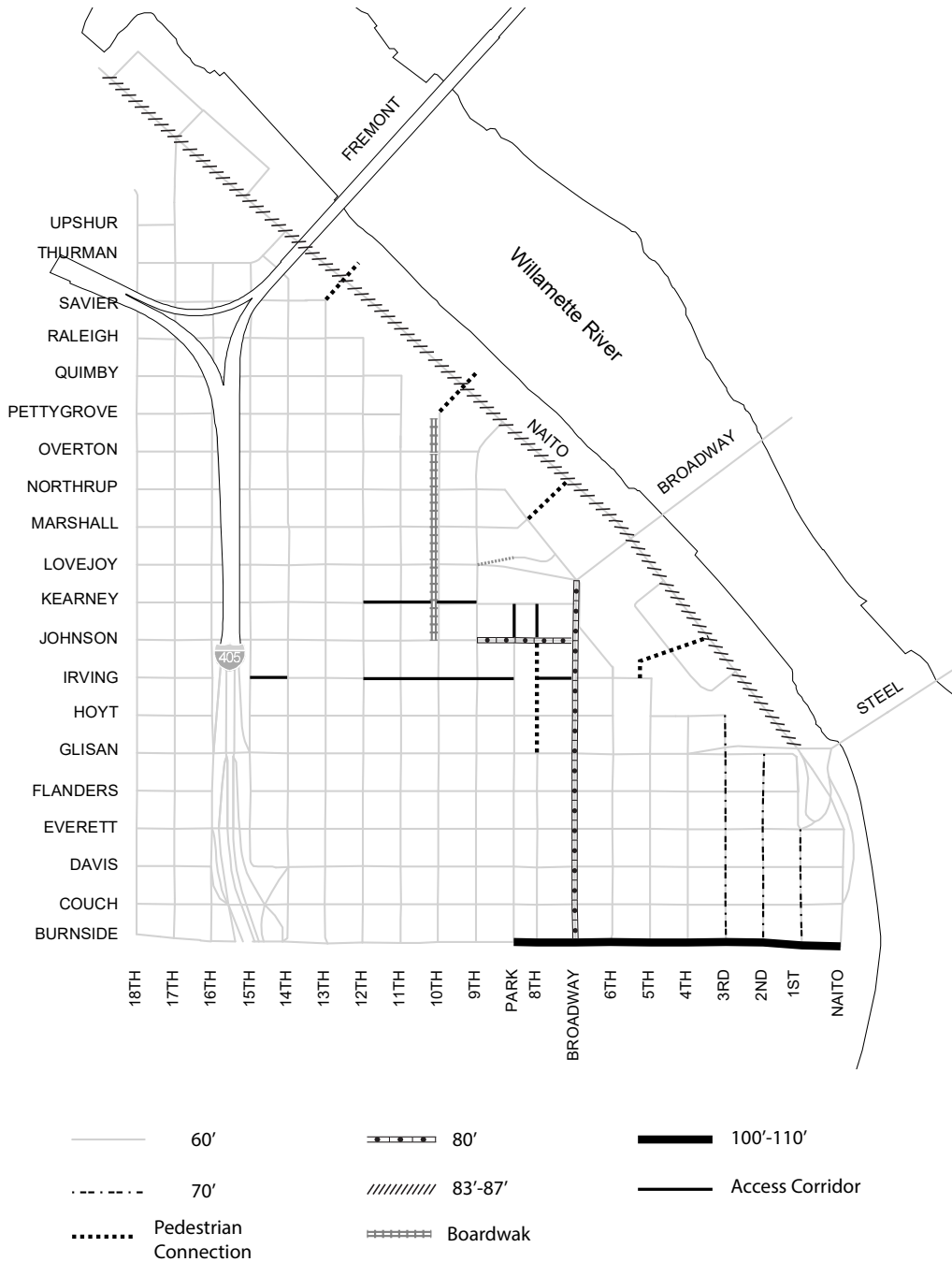

1.3 TYPICAL RIVER DISTRICT STREETS

The predominant existing street width for two lane streets with on-street parking in the River District is 36 feet curb-to-curb. An optional width for new two lane street extensions is 34 feet which allows wider sidewalks in more pedestrian intensive areas.

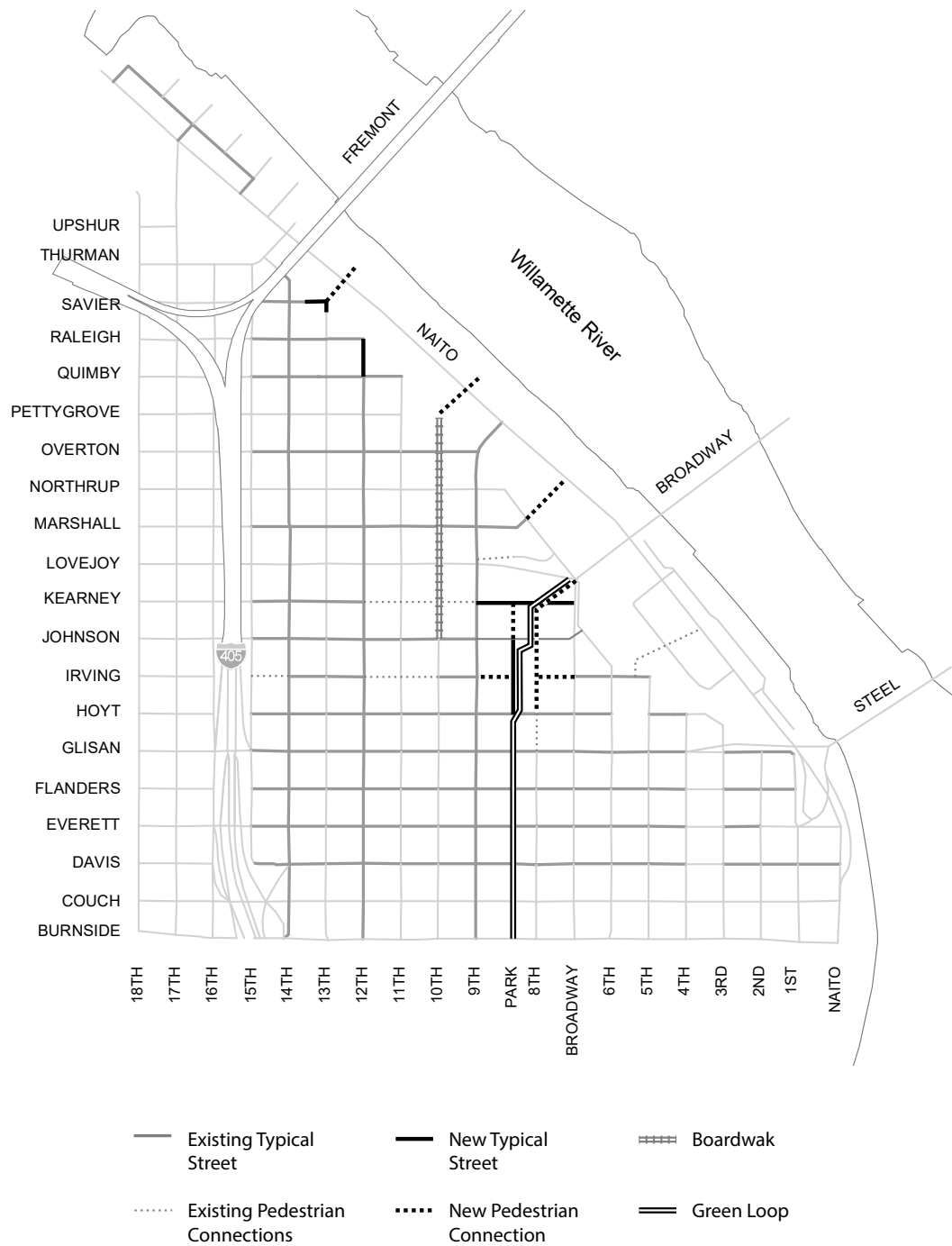

I.4 SPECIAL FUNCTION RIVER DISTRICT STREETS

There are a variety of street widths for Special Function Streets in the River District. Naito, Broadway, 1st, 2nd and 3rd carry through-traffic from beyond the area and thus are wider than typical River District streets. Others, such as the North Transit Mall, the Park Block streets and the access corridors are specialized in their use and design configuration. Pettygrove is envisioned as a “green street” with wide sidewalks and less on-street parking, eventually leading from the Fields Park to Wallace Park in Northwest. See Appendix for details.

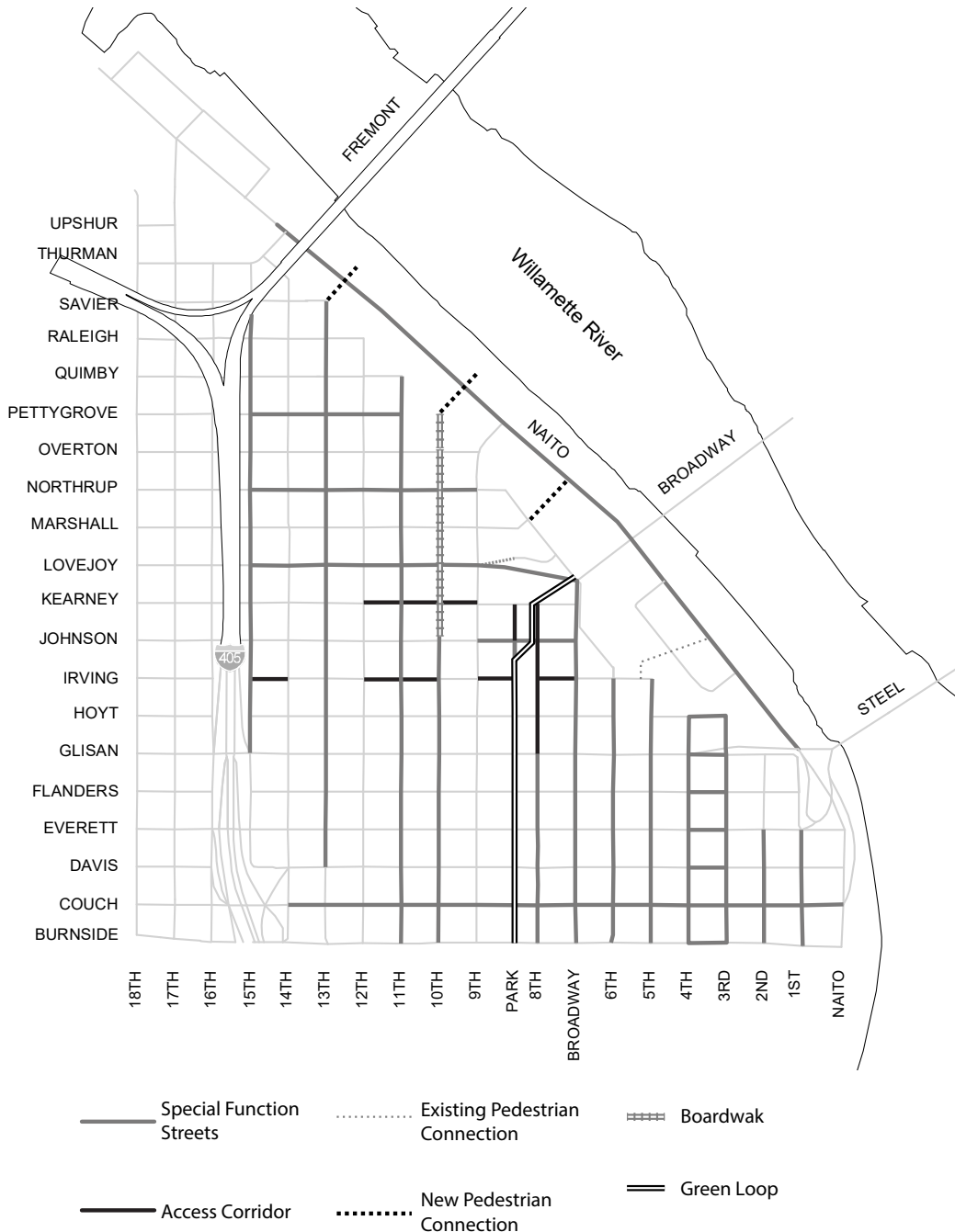

	1.4.18 Johnson Street NW 9th Ave to NW Station Way*	1.4.19 Johnson Street NW Park Ave to NW 8th Ave
Right-of-way	80 ft.	80 ft.
Roadway	28 ft.	28 ft.
Sidewalks	15 ft. and 20 ft on north side; 15 ft on south side	15 ft. and 20 ft on north side; 15 ft on south side
Curblines	May be extended at corners	May be extended at corners
Circulation	Two-way two lanes with protected bike lane	Two-way two lanes with protected bike lane
Parking	Allowed one side	Allowed one side

*Curbsless level surface design from NW Park Avenue to NW 8th Avenue
Wide sidewalk furnishing zone on north side supports larger tree canopy sizes.

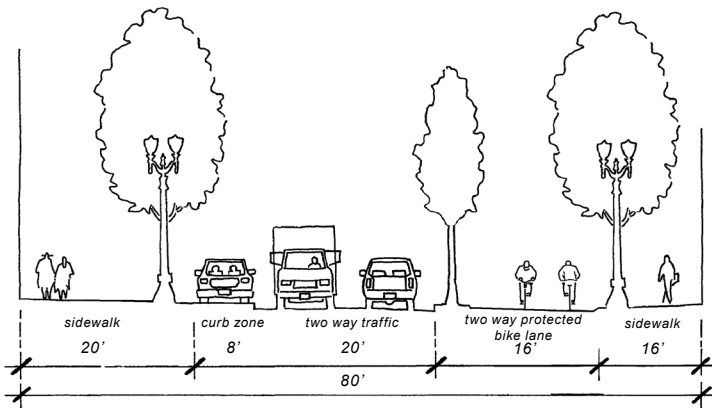

Johnson Street - Traditional

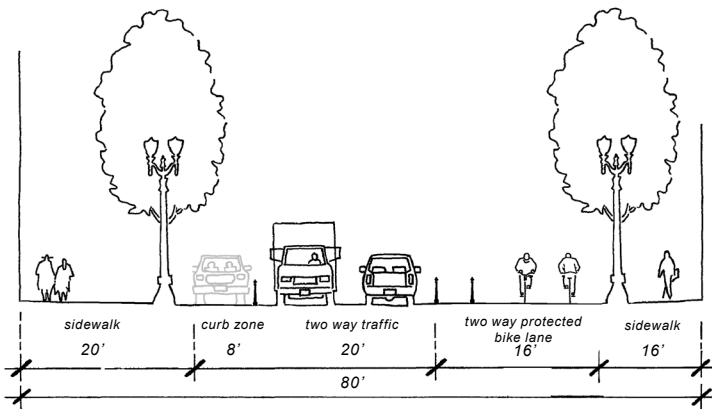

Johnson Street - Level Surface

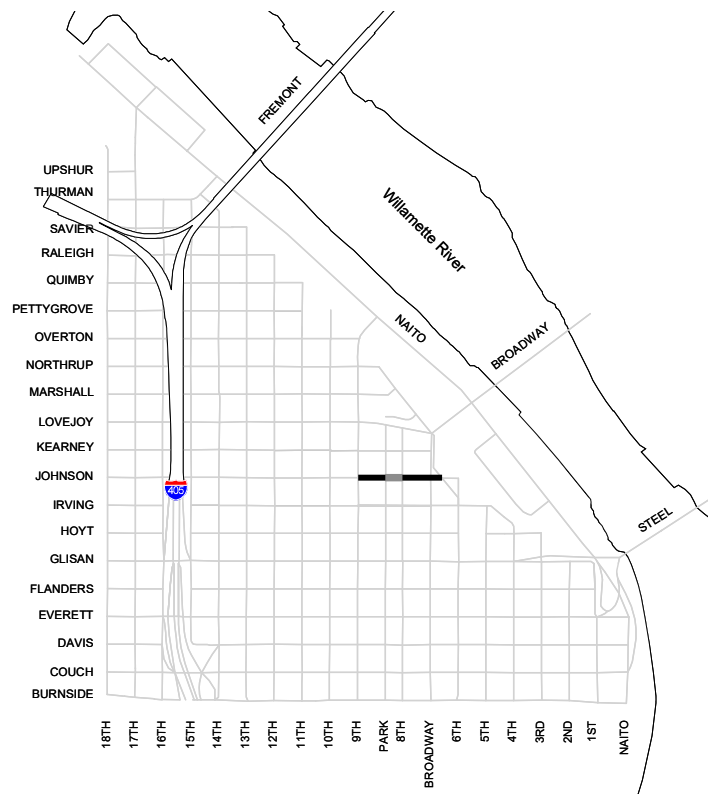

— Traditional Johnson Street - 80 ft right-of-way
— Level Surface Johnson Street - 80 ft right-of-way

	1.4.20 Park Avenue W Burnside to NW Hoyt	1.4.21 Park Avenue NW Hoyt to NW Johnson
Right-of-way	60 ft	60 ft
Roadway	18 ft	28 ft
Sidewalks	Continue existing pattern (no sidewalk on west side frontage, walkway in the park)	Continue existing pattern (no sidewalk on west side frontage, walkway in the park)
Green Loop	Integrated within roadway, preserves park landscaping.	Integrated into park frontage.
Curblines	Straight	No curb. Tree well and landscape may be extended.
Circulation	One-Way, one lane with Green Loop path	Two-Way, Two lanes with Green Loop path
Parking	Allowed west side	Allowed west side

Curbless level surface design from NW Glisan to NW Johnson.
See Green Loop Performance Criteria 2.11.

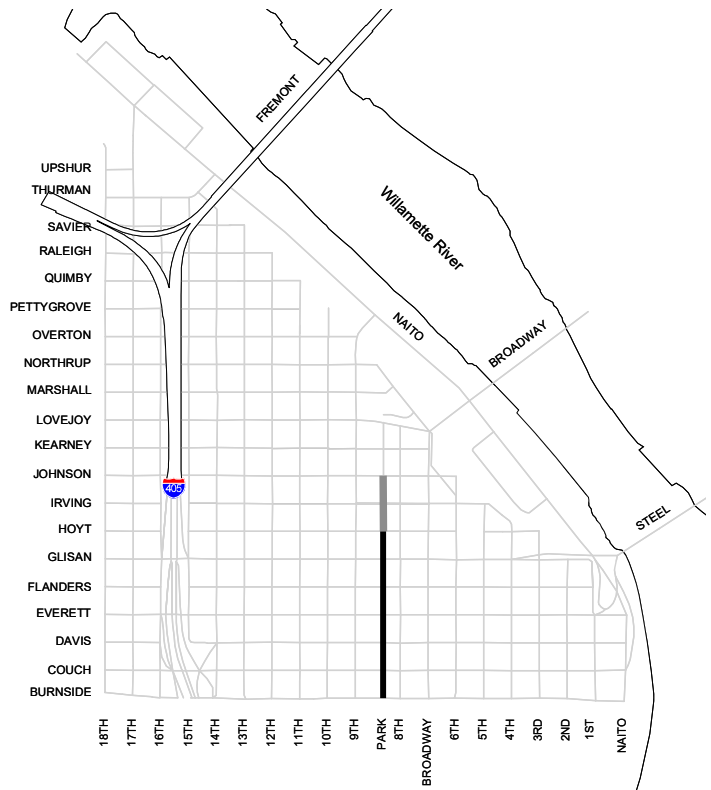
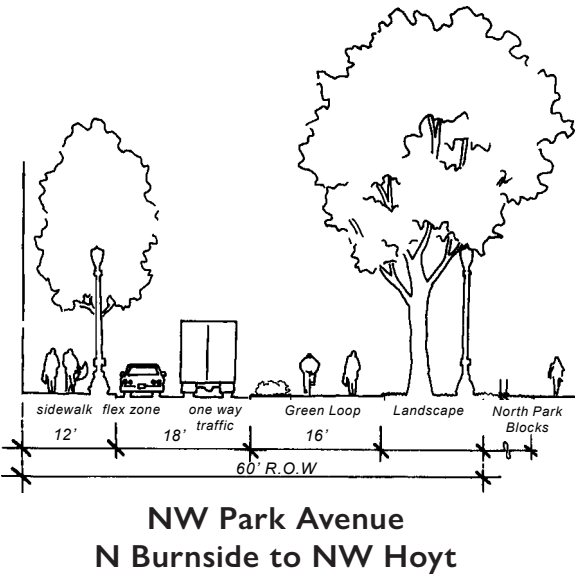
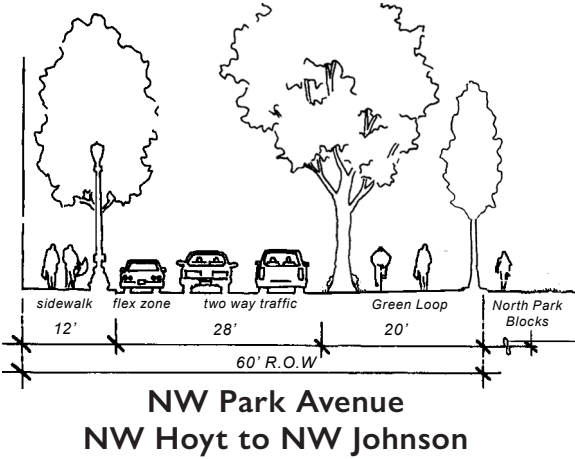

— Traditional Park Avenue
— Level Surface Park Avenue

1.4.22 ACCESS CORRIDOR

Private pedestrian/bicycle/vehicle tracts with landscaping and street lighting on public easements, 40-60 feet wide, which approximates the original 200 ft. block pattern. See Performance Criteria 2.5.1.4.

1.5 STREET TREES

The selection of tree species and the layout of trees on different streets is related to both the operation and desired character of a particular street. Examples range from significant traffic streets with narrow upright street trees to minor traffic streets with broad headed street trees. Species selection and tree spacing has been coordinated with the City Forestry Division.

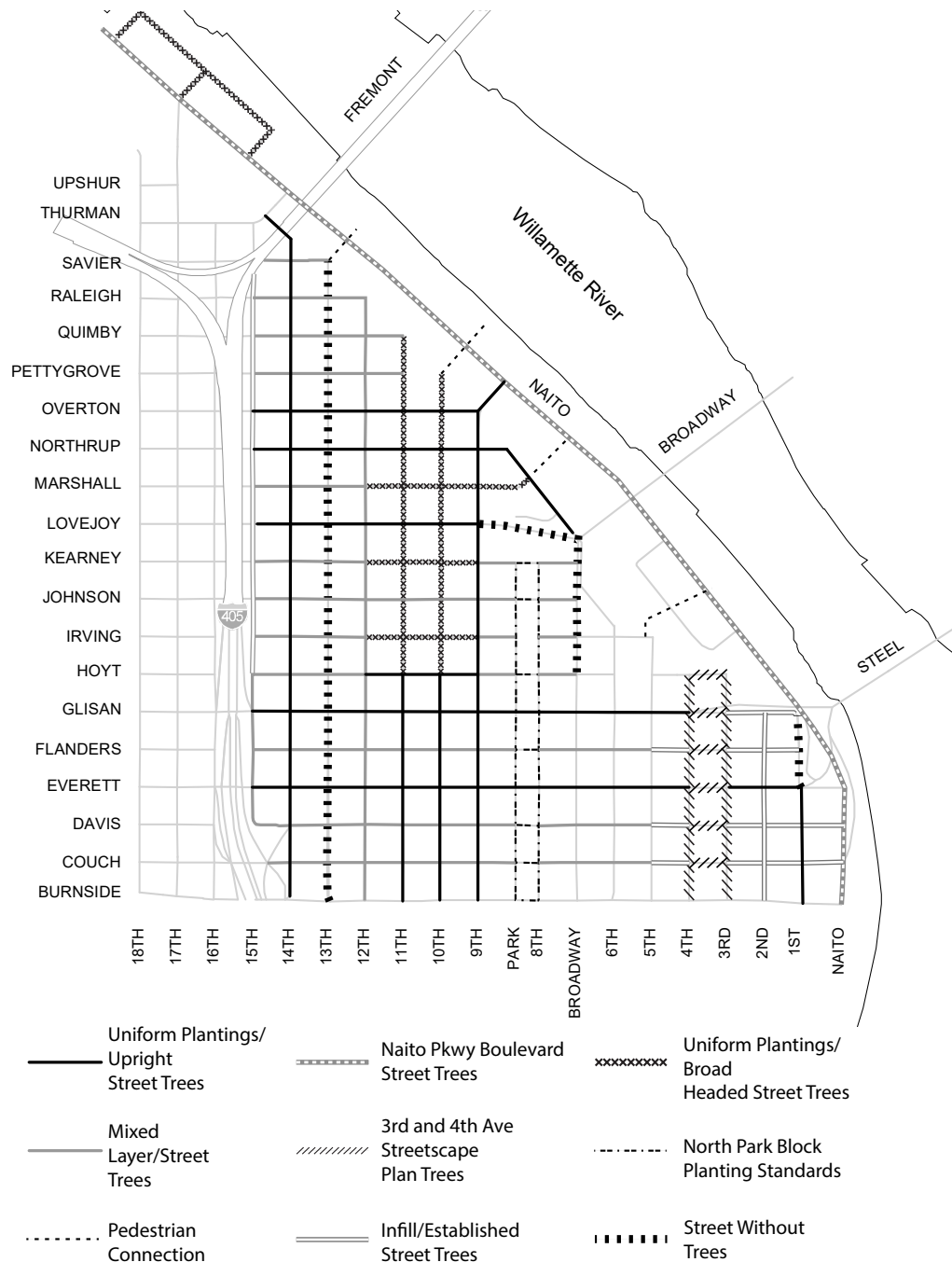

1.6 STREET LIGHTING

The street lighting plan reflects existing and proposed fixtures for various streets in the River District. The indication of fixture type and spacing for a particular street is based on the continuation or extension of existing design character within the district and continuity with the urban design pattern beyond the district. These recommendations have been coordinated with the Street Lighting Division of the Bureau of Transportation Engineering and Development.

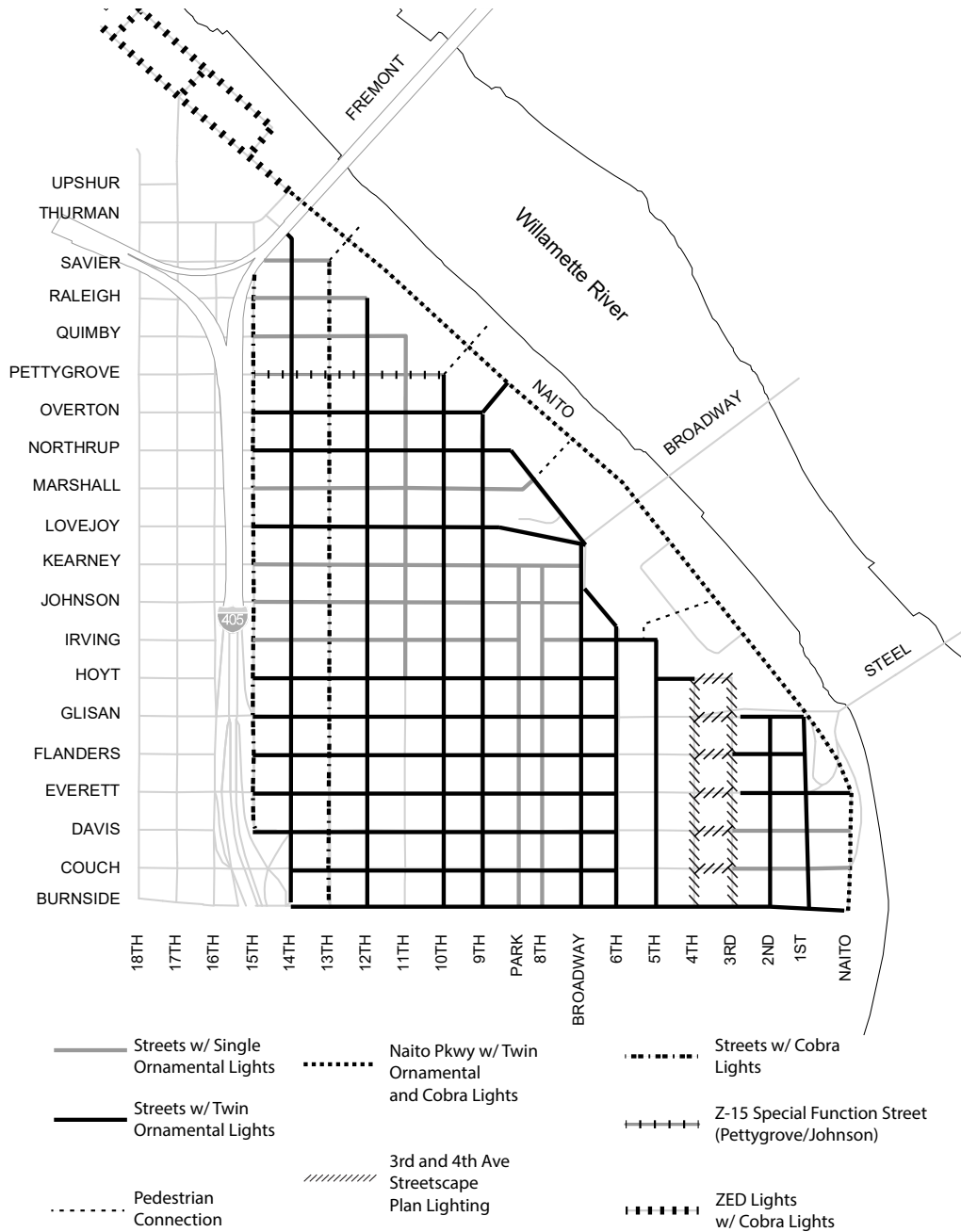

2.11 JOHNSON AND PARK SPECIAL FUNCTION STREETS

NW Johnson and NW Park Ave are classified as Special Function Streets to advance the recommendations of the USPS Master Plan through a distinctive streetscape and urban design form.

Schematic design standards for NW Johnson and NW Park are available in 3.6 Special Function Street Design Standards. The schematic design standards show major streetscape design elements and generalized facility dimensions, but don't articulate fine details related to materials and construction. These streets are required to go through a detailed design process as a part of the design and engineering phase for construction. Final street design, construction and material selection requires approval from the City Engineer.

Common elements to these streets include:

- Level surface “curbless” street design, designed flush from lot line-to-lot line;
- Textured materials that distinguish active and social spaces;
- Limited amounts of on-street parking to provide short-term retail access for those arriving by automobile;
- Speed management features such as narrow lanes, in-street landscaping, slight chicanes;
- Bollard-controlled access to manage streets for public events, farmer's markets, and other car-free events.

2.11.1 LEVEL SURFACE DESIGN

The use of a level surface design provides a unique building-to-building park-like experience through the USPS site.

- Follow best practices for accessible design and compliance with the Americans with Disabilities Act (ADA).
- Use bollards, landscaping and trees where appropriate to establish physical separation between walking and biking zones and the motor vehicle travel area.
- Design stormwater drainage to manage water flows to prevent unwanted flows and ponding in pedestrian or bicycle-oriented areas.

2.11.2 TEXTURED MATERIALS

Construction materials should be selected to provide a high quality finish and to delineate different street-use zones while accommodating needs for maintenance and utility access.

- Design the pedestrian realm for visual compatibility with the standard concrete scoring patterns used in the River District. See 3.11 Modular Layout of Sidewalks and Vertical Elements.
- Distinct paving block patterns and pattern orientations should be used to distinguish between street use zones. For example, different interlocking patterns or subtle material color variation should be used to visually separate the pedestrian area from the roadway travel area.
- Textured materials in space designed for bicycles should be compatible with that use.
- Consider use of rough-surface materials such as Belgian blocks or cobblestones within furnishing zone or buffer areas as a detectable surface.

2.11.3 FLEXIBLE USE AND LIMITED ON-STREET PARKING

The curb zone (formerly known as on-street parking lane) should emphasize access and place-making functions such as parking, loading, street trees, curb extensions, and street seats as needed to support adjacent land use and improve the pedestrian realm.

- Where on-street motor vehicle parking is provided, manage the curb-zone to prioritizing short stops and turnover to serve retail and visitor access. (TSP 9.54).

2.11.4 DESIGN FOR SLOW SPEEDS

Roadway design should use all available tools to create slow, people-friendly design speeds. This may include: textured surfaces, narrow lanes, in-roadway landscaping, horizontal shifts, tabled intersections and midblock crossings.

2.11.5 BOLLARD-CONTROLLED ACCESS MANAGEMENT

These streets should be designed for easy access management during community events through the use of removable or retractable bollards.

2.12 GREEN LOOP CRITERIA

The Green Loop is a signature linear park and urban promenade that connects east and west side neighborhoods to open spaces and the Willamette River, with high quality active transportation accommodations, urban social activities, tree canopy, park-like pedestrian environments, and wildlife habitat connections. Final design to be completed as part of engineering individual street improvement projects.

2.12.1 GREEN LOOP USE ZONES

Dimensions described here assume typical street conditions and may fluctuate in response to available street space, adjacent land use, building interactions, and coordination with adjacent open space. Use of minimum-dimensions for all zones is not recommended. Where the Green Loop travels adjacent to a public park, explore the opportunity to merge the park design with right-of-way functions for increased facility integration.

2.12.1.1 Building Frontage Zones:

The area of sidewalk directly abutting buildings. This space is outside of the through pedestrian zone and typically accommodates pedestrian furniture such as café tables. Along the green loop, this space should also be used for building adjacent landscaping and living-wall installations.

Size: 2.5 feet or greater (1.5 ft minimum).

Application: On Green Loop segments in the CC2035 Plan.

2.12.1.2 Through Pedestrian Zone:

an accessible path for the exclusive use of pedestrians.

Size: 8 feet (6 feet minimum)

Application: On Green Loop segments in the CC2035 Plan. Through Pedestrian Zone may be excluded on segments fronting a park if a parallel walkway is provided within an adjacent park.

2.12.2.3 Separation Zone:

provides physical separation between the Through Pedestrian Zone and the Green Loop Path Zone. This zone provides a detectable edge between zones and is an opportunity for additional landscaping and placemaking uses.

Size: 6 ft or greater (1 ft minimum).

Application: On Green Loop segments in the CC2035 Plan. Must be detectable by people with vision disabilities.

2.12.1.4 Green Loop Path Zone:

an accessible path designed to support bicycling, scooting, skateboarding, roller-skating, people using mobility devices and other similar uses. People walking are welcome to share the path with other users.

Size: 16 feet for typical for high capacity accommodation (12 feet minimum).

Application: On Green Loop segments section of the CC2035 Plan.

2.12.1.5 Path Furnishing Zone:

provides physical separation from the adjacent travel lanes. Along the green loop, this space should be used for landscaping, in addition to conventional furnishing zone uses (see 2.5.2.3 Furnishing Zone).

Size: 6 ft or greater (4 ft minimum).

Application: On Green Loop segments in the CC2035 Plan.

2.12.1.6 Curb Edge:

the curb separating the green loop path from the roadway. On special streets with level surface street designs, other design tools may be used to separate the path from the roadway.

Size: 1 ft (0.5 ft min)

Application: Along the green loop alignment in the CC2035 Plan.

2.12.2 GREEN LOOP DESIGN PRINCIPLES

Standards for detailed Green Loop designs and land use integration will be addressed in future updates of the Central City Fundamental Design Guidelines, and the creation of the Green Loop Streetscape Design Standards. The following Design principles apply to all segments of the green loop.

- **Building Orientation:** New development should orient its storefronts or building lobbies toward the Green Loop. New ground floor activity will provide greater visibility and connectivity to the loop and create a safe and more active environment.
- **Multi-Use Path:** The Green Loop path can accommodate a variety of different active uses at low speeds including walking, jogging, biking, scooting and skating and will be a defining feature of the Green Loop. Depending on the context these uses can be clustered together or separated by greenery or other features.
- **Physical Separation:** The Green Loop concept includes physically separated paths to minimize conflicts between people using the paths and people driving. These separated corridors will create safer, more intuitive pathways through the Central City for people no matter how they actively get around.
- **Connected Canopy:** A key wayfinding element of the Green Loop will be a distinctive approach to trees and other green features. The character of landscape plantings will vary along different segments of the Green Loop, being responsive to adjacent needs and local character while helping to clarify the route and improve environmental performance.

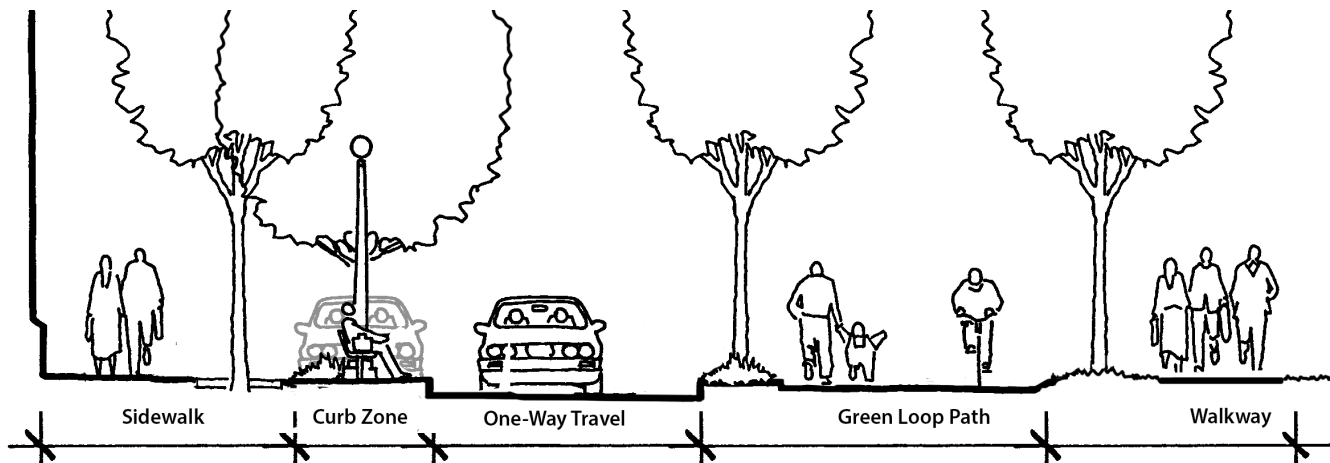

Green loop design dimensions will respond to available right-of-way, parking, and circulation needs.

- **Branding/Identity:** The paths and adjacent properties will feature wayfinding and environmental design tools to help residents and visitors identify where they are while reflecting the local character of the various districts that the loop moves through.
- **Unique Street Furnishings:** Street furnishings along the Green Loop will help distinguish the path, emphasizing its linear park environment and supporting activity nodes. The specific amenities and their locations will vary with right-of-way width and the adjacent ground floor uses and local character..

2.13 CONSTRUCTABILITY AND MAINTENANCE

All proposed designs should be reviewed for ease of construction and maintenance by the Bureau of Transportation Maintenance and Operations Group.

2.13.1 In-place Construction:

pavement, walls, structures, landscape, etc., should be designed in a manner that allows straightforward and efficient construction techniques; minimize designs that require complicated construction sequences with multiple trades; if work is to be phased, provide clear joints or breaks in construction that make subsequent additions or replacements easy; build with proven, durable materials.

2.13.2 Manufactured Components:

joint materials, wall materials, vault doors, fasteners, etc., use items that meet all applicable codes and standards; should be proven, durable components in standardized sizes to simplify replacement.

2.13.3 Fabricated Items:

shelters, railings, grates, protective plates, covers, etc., build items that meet all applicable codes and standards; should be designed for shop fabrication whenever possible-minimize field modifications or adjustments; should use proven, durable components in standardized sizes to simplify replacement.

2.13.4 Manufactured Stand-Alone Fixtures:

furnishings, light standards, etc.; use items that meet all applicable codes and standards; where continuity is desired within subdistricts or along continuous corridors, match previous installation; use proven, durable items; use fastening design that allows easy but tamperproof removal for maintenance.

DESIGN STANDARDS

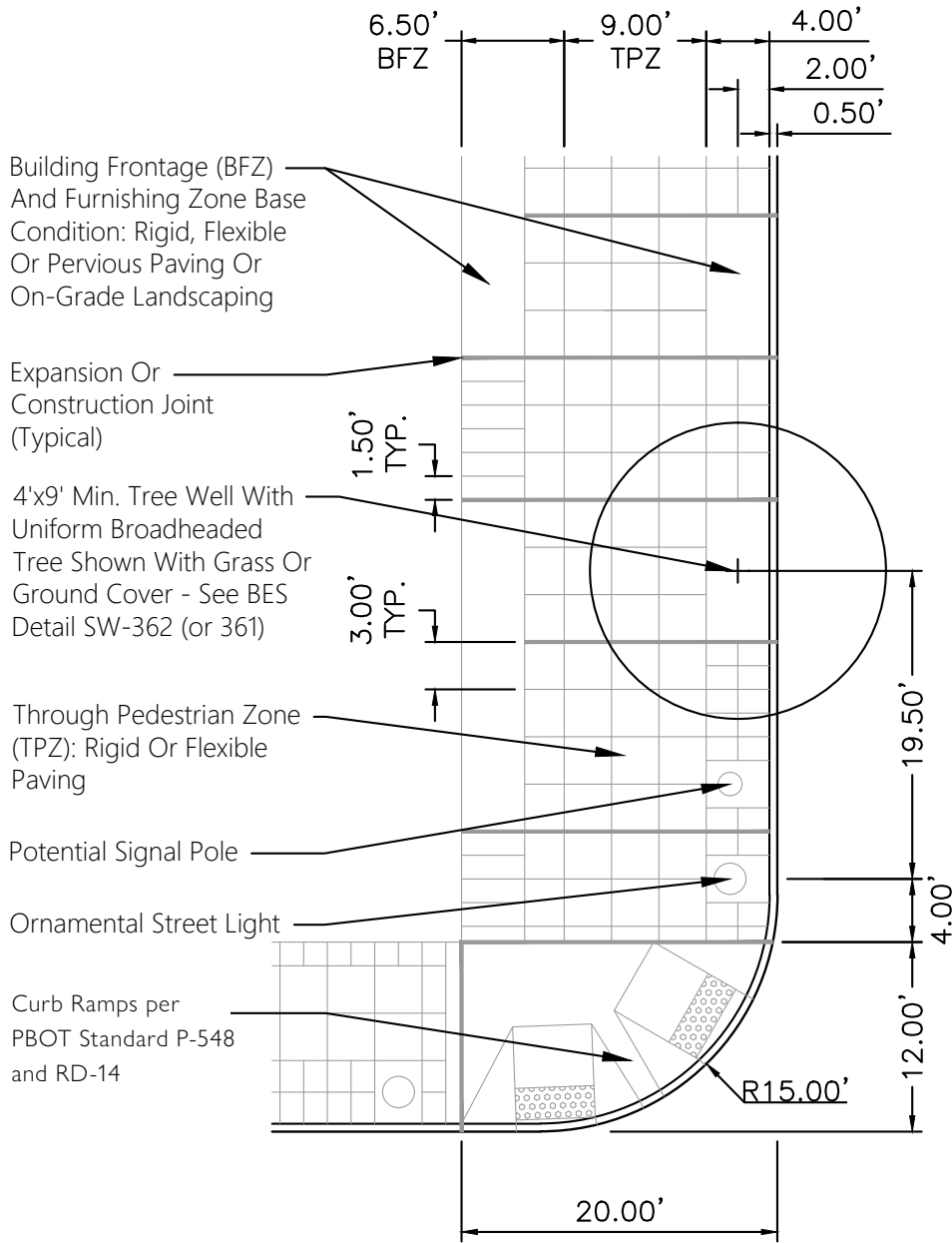

Building Frontage (BFZ) And Furnishing Zone Base Condition: Rigid, Flexible Or Pervious Paving Or On-Grade Landscaping

Expansion Or Construction Joint (Typical)

4'x9' Min. Tree Well With Uniform Broadheaded Tree Shown With Grass Or Ground Cover - See BES Detail SW-362 (or 361)

Through Pedestrian Zone (TPZ): Rigid Or Flexible Paving

Potential Signal Pole

Ornamental Street Light

Curb Ramps per PBOT Standard P-548 and RD-14

Partial Plan

Scale: 1" = 10'

THIS IS A PRELIMINARY CONCEPT. FIELD VERIFICATION, SITE CONDITION ASSESSMENTS, ENGINEERING ANALYSIS AND DESIGN ARE NECESSARY PRIOR TO IMPLEMENTING ANY OF THE RECOMMENDATIONS CONTAINED HEREIN.

The selection and use of this Standard Drawing, while designed in accordance with generally accepted engineering principles and practices, is the sole responsibility of the user.

Note: All material and workmanship shall be in accordance with the City of Portland Standard Construction Specifications

20' SIDEWALK BASE CONDITION

#	REVISIONS	DATE	BY	APPROVED	STANDARD PLAN NO.
				CITY ENGINEER	RD-26
				DATE	
CITY OF PORTLAND, OREGON					

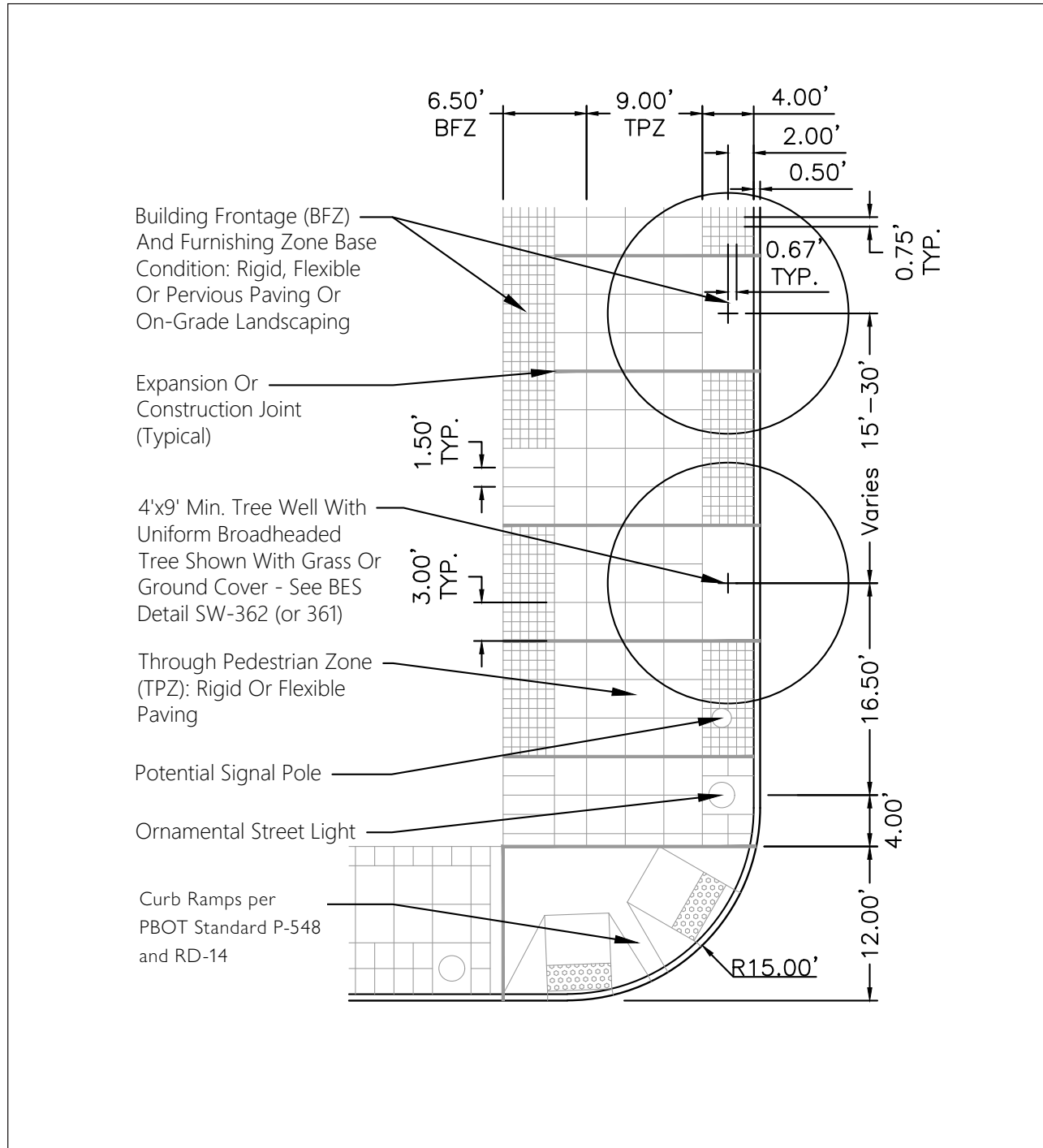

- Building Frontage (BFZ) And Furnishing Zone Base Condition: Rigid, Flexible Or Pervious Paving Or On-Grade Landscaping
- Expansion Or Construction Joint (Typical)
- 4'x9' Min. Tree Well With Uniform Broadheaded Tree Shown With Grass Or Ground Cover - See BES Detail SW-362 (or 361)
- Through Pedestrian Zone (TPZ): Rigid Or Flexible Paving
- Potential Signal Pole
- Ornamental Street Light
- Curb Ramps per PBOT Standard P-548 and RD-14

Scale: 1" = 10'

Partial Plan

THIS IS A PRELIMINARY CONCEPT. FIELD VERIFICATION, SITE CONDITION ASSESSMENTS, ENGINEERING ANALYSIS AND DESIGN ARE NECESSARY PRIOR TO IMPLEMENTING ANY OF THE RECOMMENDATIONS CONTAINED HEREIN.

The selection and use of this Standard Drawing, while designed in accordance with generally accepted engineering principles and practices, is the sole responsibility of the user.

Note:
All material and workmanship shall be in accordance with the City of Portland Standard Construction Specifications

20' SIDEWALK PERVIOUS PAVING

#	REVISIONS	DATE	BY	APPROVED	STANDARD PLAN NO.
				CITY ENGINEER	RD-27
				CITY OF PORTLAND, OREGON	

DESIGN STANDARDS

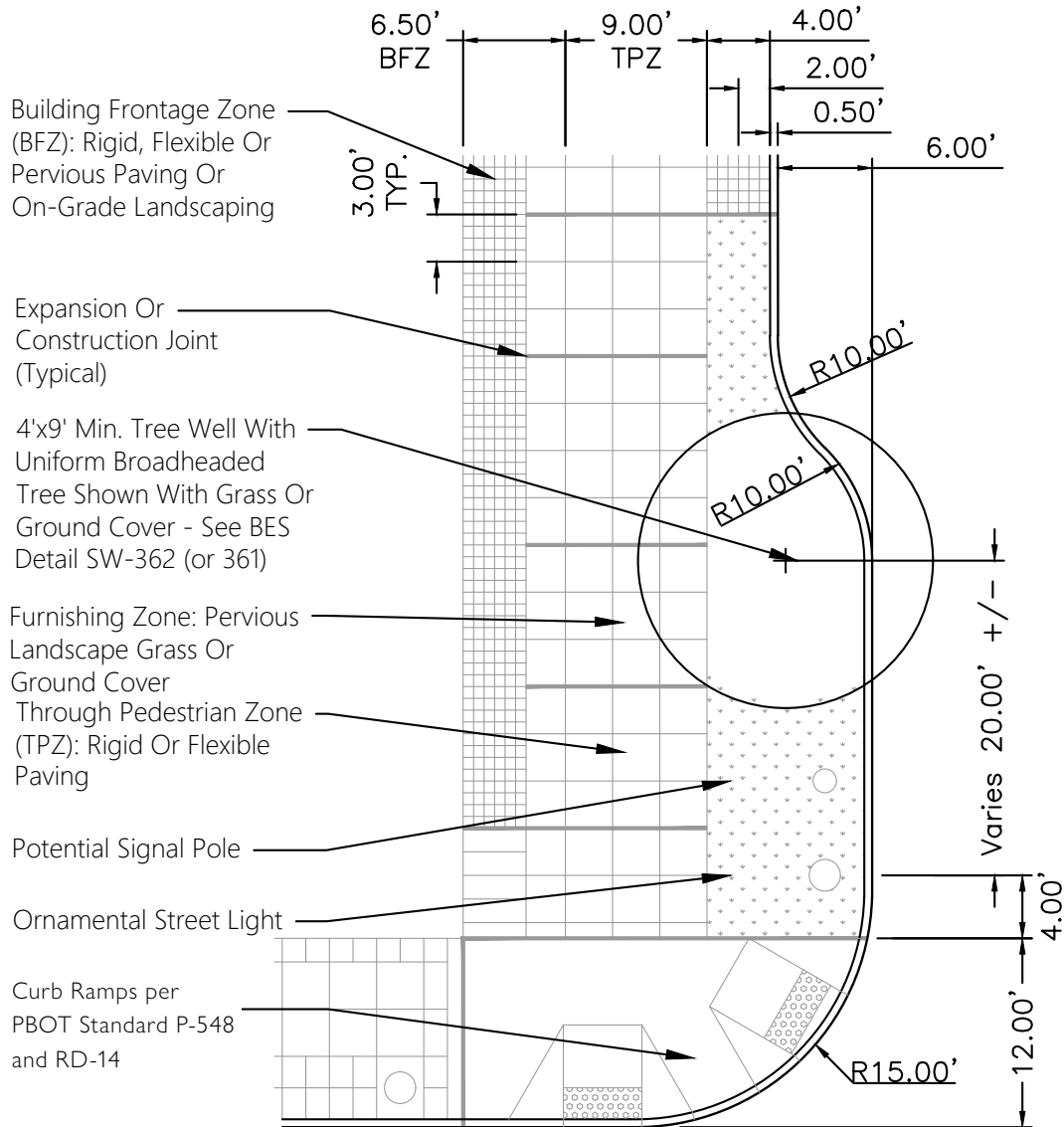

Scale: 1" = 10'

THIS IS A PRELIMINARY CONCEPT. FIELD VERIFICATION, SITE CONDITION ASSESSMENTS, ENGINEERING ANALYSIS AND DESIGN ARE NECESSARY PRIOR TO IMPLEMENTING ANY OF THE RECOMMENDATIONS CONTAINED HEREIN.

Partial Plan

The selection and use of this Standard Drawing, while designed in accordance with generally accepted engineering principles and practices, is the sole responsibility of the user.

Note:
All material and workmanship shall be in accordance with the City of Portland Standard Construction Specifications

20' SIDEWALK EXTENDED

#	REVISIONS	DATE	BY	APPROVED	STANDARD PLAN NO.
				CITY ENGINEER	RD-28
				DATE	
CITY OF PORTLAND, OREGON					

**TYPICAL SECTIONS
WITH CURB ZONE**

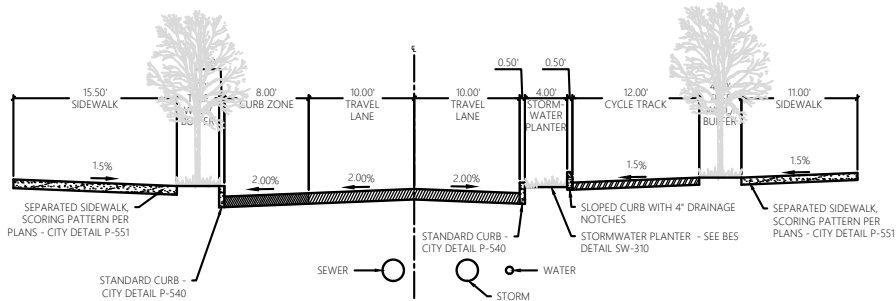

OPTION A SIDEWALK LEVEL TWO-WAY BIKE LANE

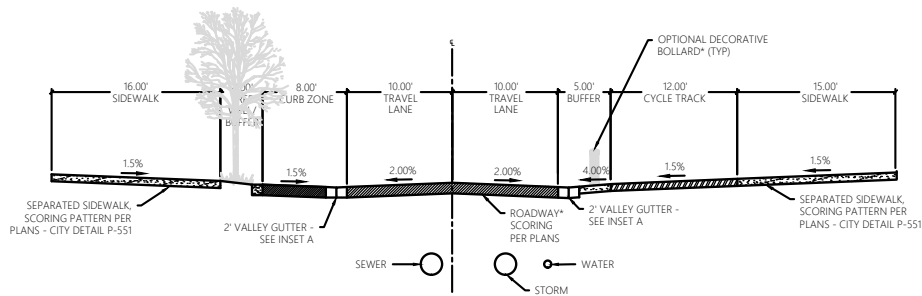

**OPTION B SIDEWALK LEVEL TWO-WAY BIKE LANE
WITH LEVEL SURFACE ROADWAY**

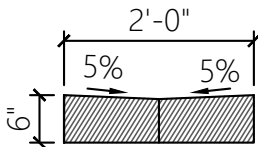

**INSET A -
CONCRETE
VALLEY
GUTTER**

*Construction materials (including decorative bollards) to be selected as part of detailed design phase in a public works project. Material and product selection subject to approval by the City Engineer.

THIS IS A PRELIMINARY CONCEPT. FIELD VERIFICATION, SITE CONDITION ASSESSMENTS, ENGINEERING ANALYSIS AND DESIGN ARE NECESSARY PRIOR TO IMPLEMENTING ANY OF THE RECOMMENDATIONS CONTAINED HEREIN.

The selection and use of this Standard Drawing, while designed in accordance with generally accepted engineering principles and practices, is the sole responsibility of the user.

Note:
All material and workmanship shall be in accordance with the City of Portland Standard Construction Specifications

CROSS SECTIONS - NW JOHNSON STREET

#	REVISIONS	DATE	BY	APPROVED	STANDARD PLAN NO.
				CITY ENGINEER	RD-29A
				DATE	
CITY OF PORTLAND, OREGON					

**TYPICAL SECTIONS
WITHOUT CURB ZONE**

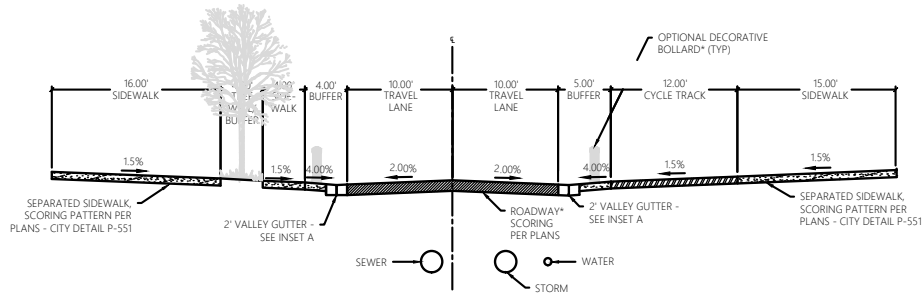

**OPTION C SIDEWALK LEVEL TWO-WAY BIKE LANE
WITH LEVEL SURFACE ROADWAY - TREES ON NORTH**

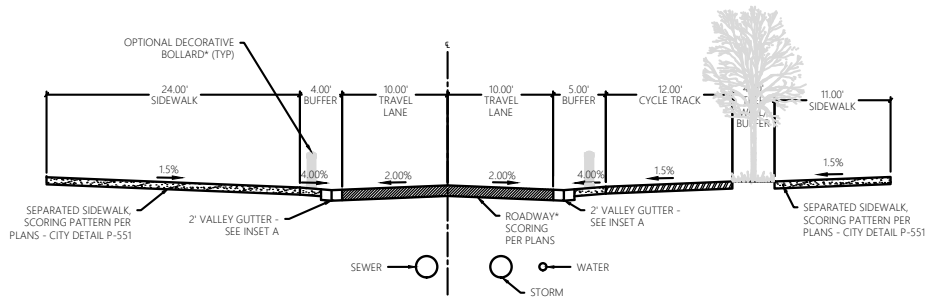

**OPTION D SIDEWALK LEVEL TWO-WAY BIKE LANE
WITH LEVEL SURFACE ROADWAY - TREES ON SOUTH**

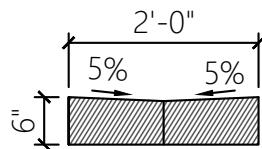

**INSET A -
CONCRETE
VALLEY
GUTTER**

*Construction materials (including decorative bollards) to be selected as part of detailed design phase in a public works project. Material and product selection subject to approval by the City Engineer.

THIS IS A PRELIMINARY CONCEPT. FIELD VERIFICATION, SITE CONDITION ASSESSMENTS, ENGINEERING ANALYSIS AND DESIGN ARE NECESSARY PRIOR TO IMPLEMENTING ANY OF THE RECOMMENDATIONS CONTAINED HEREIN.

The selection and use of this Standard Drawing, while designed in accordance with generally accepted engineering principles and practices, is the sole responsibility of the user.

Note:
All material and workmanship shall be in accordance with the City of Portland Standard Construction Specifications

CROSS SECTIONS - NW JOHNSON STREET

#	REVISIONS	DATE	BY	APPROVED	STANDARD PLAN NO.
				CITY ENGINEER	RD-29B
				DATE	
CITY OF PORTLAND, OREGON					

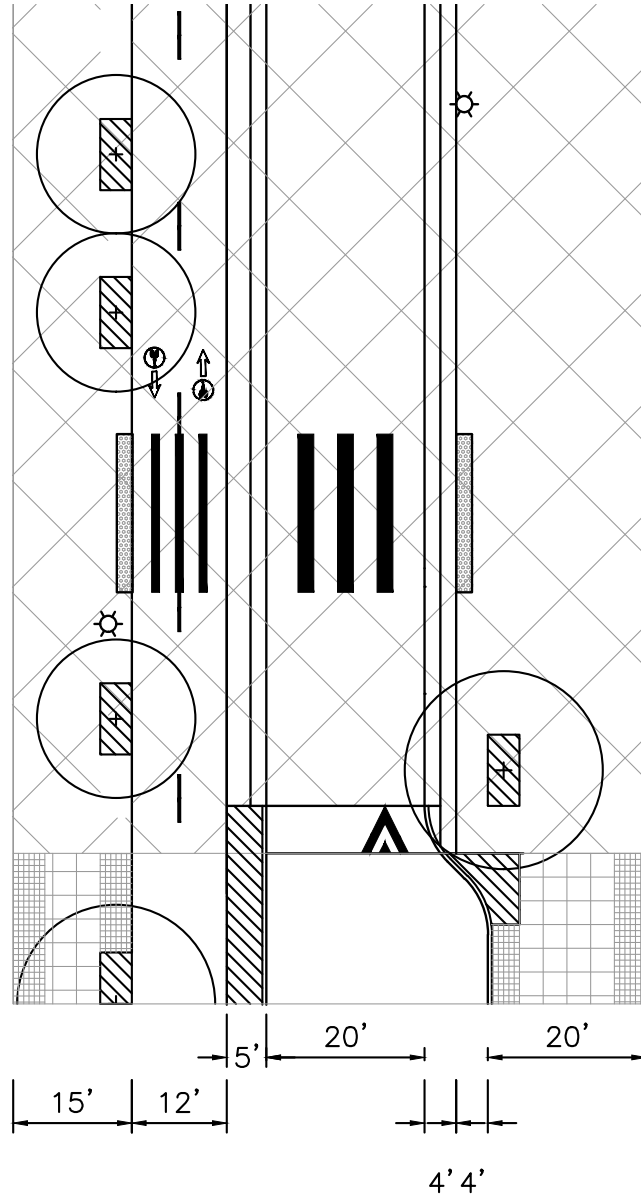

Scale: 1" = 20'

THIS IS A PRELIMINARY CONCEPT. FIELD VERIFICATION, SITE CONDITION ASSESSMENTS, ENGINEERING ANALYSIS AND DESIGN ARE NECESSARY PRIOR TO IMPLEMENTING ANY OF THE RECOMMENDATIONS CONTAINED HEREIN.

The selection and use of this Standard Drawing, while designed in accordance with generally accepted engineering principles and practices, is the sole responsibility of the user.

Note:
All material and workmanship shall be in accordance with the City of Portland Standard Construction Specifications

NW JOHNSON STREET - CURBLESS STREET DETAIL

#	REVISIONS	DATE	BY	APPROVED	STANDARD PLAN NO.
				CITY ENGINEER	RD-30A
				DATE	
CITY OF PORTLAND, OREGON					

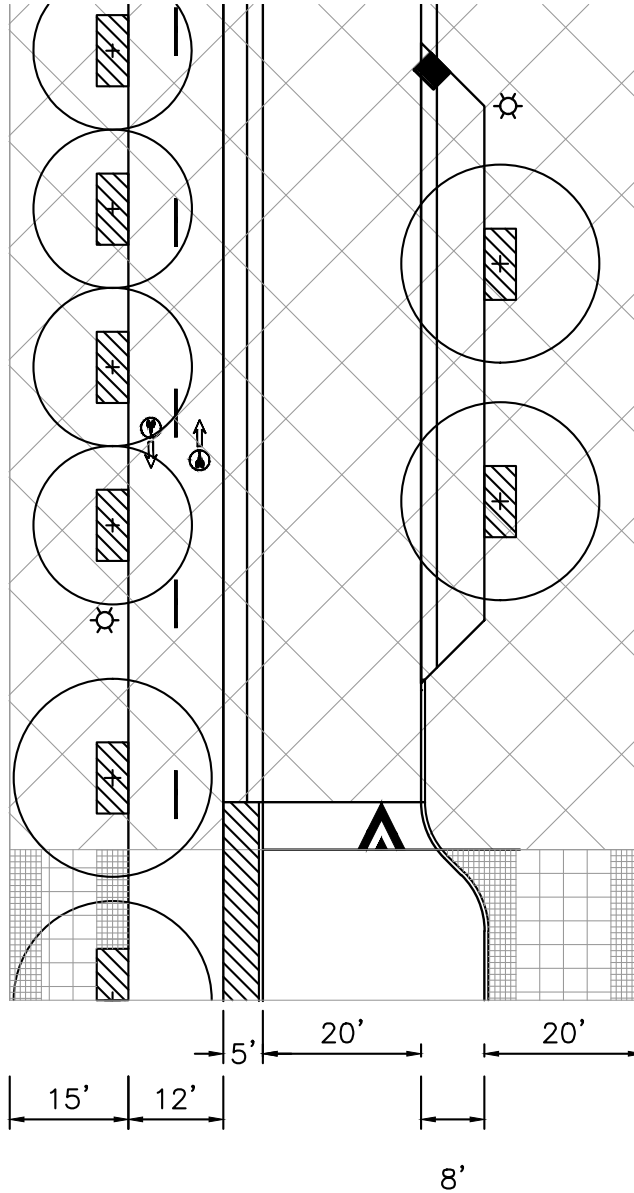

Scale: 1" = 20'

THIS IS A PRELIMINARY CONCEPT. FIELD VERIFICATION, SITE CONDITION ASSESSMENTS, ENGINEERING ANALYSIS AND DESIGN ARE NECESSARY PRIOR TO IMPLEMENTING ANY OF THE RECOMMENDATIONS CONTAINED HEREIN.

The selection and use of this Standard Drawing, while designed in accordance with generally accepted engineering principles and practices, is the sole responsibility of the user.

Note:
All material and workmanship shall be in accordance with the City of Portland Standard Construction Specifications

NW JOHNSON STREET - CURBLESS STREET DETAIL

#	REVISIONS	DATE	BY	APPROVED	STANDARD PLAN NO.
				CITY ENGINEER	RD-30B
				DATE	
CITY OF PORTLAND, OREGON					

TYPICAL SECTION

*Construction materials (including decorative bollards) to be selected as part of detailed design phase in a public works project. Material and product selection subject to approval by the City Engineer.

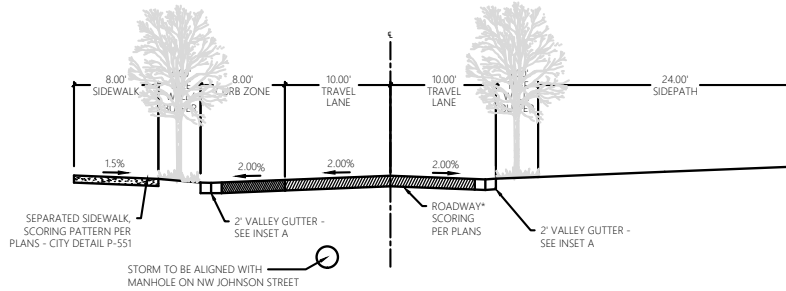

LEVEL SURFACE ROADWAY WITH PARKING AND SIDE PATH

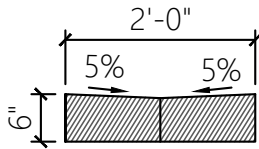

INSET A - CONCRETE VALLEY GUTTER

THIS IS A PRELIMINARY CONCEPT. FIELD VERIFICATION, SITE CONDITION ASSESSMENTS, ENGINEERING ANALYSIS AND DESIGN ARE NECESSARY PRIOR TO IMPLEMENTING ANY OF THE RECOMMENDATIONS CONTAINED HEREIN.

The selection and use of this Standard Drawing, while designed in accordance with generally accepted engineering principles and practices, is the sole responsibility of the user.

Note:
All material and workmanship shall be in accordance with the City of Portland Standard Construction Specifications

CROSS SECTIONS - NW PARK AVENUE

#	REVISIONS	DATE	BY	APPROVED	STANDARD PLAN NO.
				CITY ENGINEER	RD-31
				DATE	
CITY OF PORTLAND, OREGON					

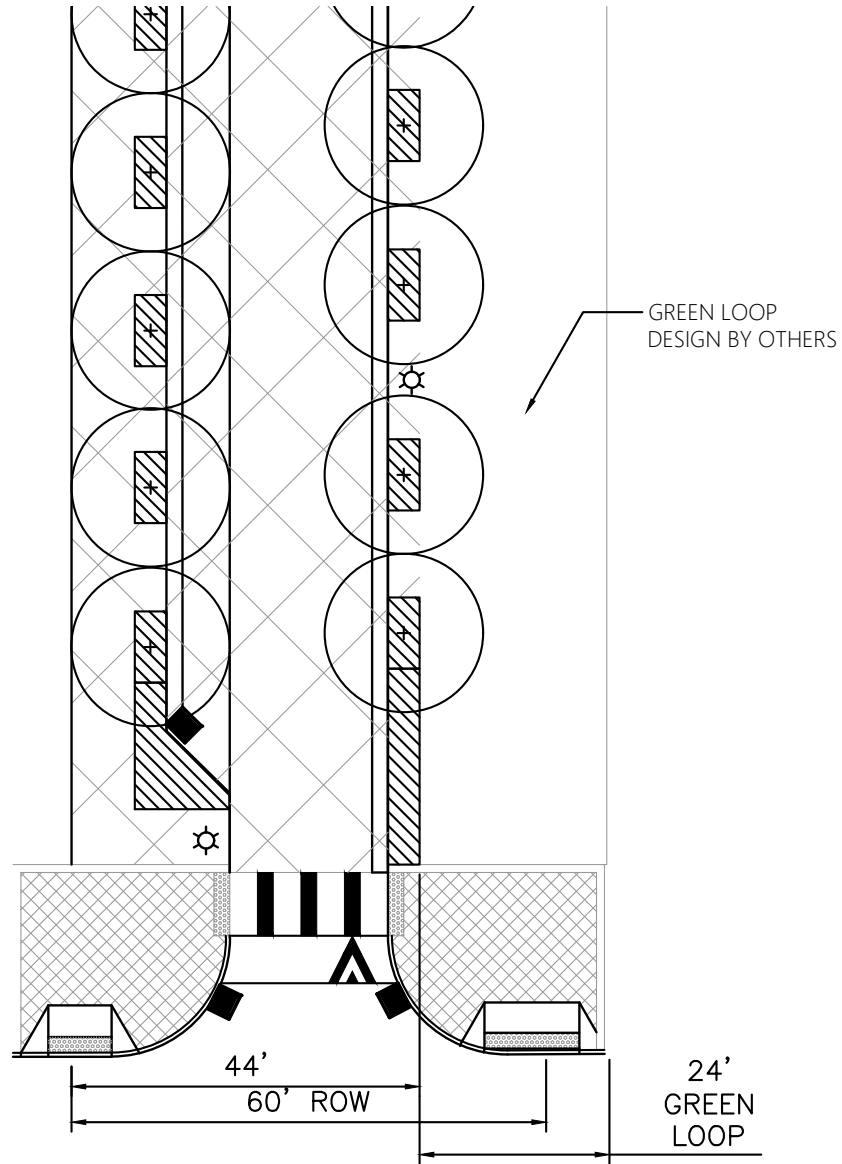

Scale: 1" = 20'

THIS IS A PRELIMINARY CONCEPT. FIELD VERIFICATION, SITE CONDITION ASSESSMENTS, ENGINEERING ANALYSIS AND DESIGN ARE NECESSARY PRIOR TO IMPLEMENTING ANY OF THE RECOMMENDATIONS CONTAINED HEREIN.

The selection and use of this Standard Drawing, while designed in accordance with generally accepted engineering principles and practices, is the sole responsibility of the user.

Note:
All material and workmanship shall be in accordance with the City of Portland Standard Construction Specifications

NW PARK AVENUE - CURBLESS STREET DETAIL

#	REVISIONS	DATE	BY	APPROVED	STANDARD PLAN NO.
				CITY ENGINEER	RD-32
				DATE	
CITY OF PORTLAND, OREGON					