



Better Housing by Design:

An update to Portland's Multi-Dwelling Zoning Code

Work Session #5

Planning and Sustainability Commission

December 11, 2018



Bureau of Planning and Sustainability
Innovation. Collaboration. Practical Solutions.



Better Housing by Design Work Session

December 11, 2018

Topics: BHD-RIP reconciliation, carry-over topics

Specific items under consideration:

1. BHD-RIP regulations for front garages and parking
2. Updates:
 - Visitability bonus
 - Analysis of East Portland deep rear setbacks proposal



Front Garages and Parking - Background

Multi-unit buildings especially should contribute to the street.



Intent of front garage and parking limitations:

- Contribute to pedestrian-friendly street environments
- Continue neighborhood patterns of front yards/gardens
- Preserve options for on-street parking and street trees



Front Garages and Parking - Background



Issues with front garages and parking:

- Impacts pedestrian environment and neighborhood context
- Paved areas instead of front yards and gardens
- Loss of on-street parking and space for street trees
- Accessibility issues with living space raised above garages



Front Garages and Parking - Background



Alternatives and trade offs: front parking

- Negative impact on street environment, parking, street trees
- Provides off-street parking / storage
- Allows for backyards



Front Garages and Parking - Background

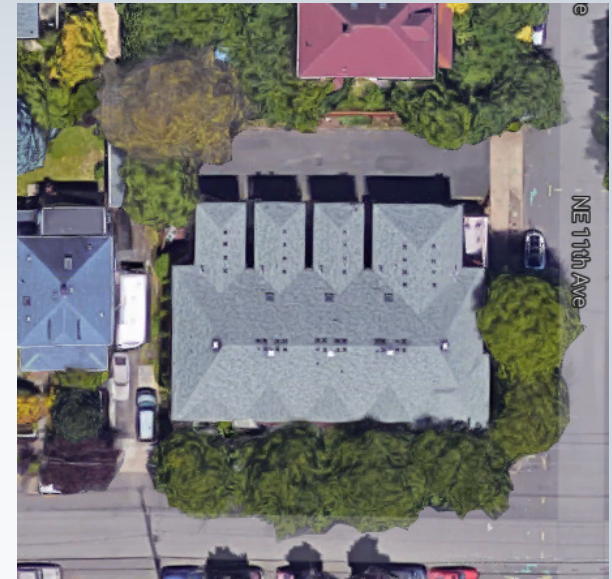

Alternatives and trade offs: rear parking

- Pedestrian-friendly street environment, on-street parking and street trees
- Provides off-street parking / storage
- More impervious surfaces, loss of backyards



Front Garages and Parking - Background



Alternatives and trade offs: no parking

- Pedestrian-friendly street environment, on-street parking and street trees
- No off-street parking, less storage/flex space
- Less impervious surfaces, more opportunities for backyards



Front Garages and Parking - Background



Both BHD and RIP would prevent garages from occupying the majority of ground-level facades (50% limit)



Front Garages and Parking - Background



Both BHD and RIP allow front garages when occupying no more than 50% of facades



Front Garages and Parking - Background

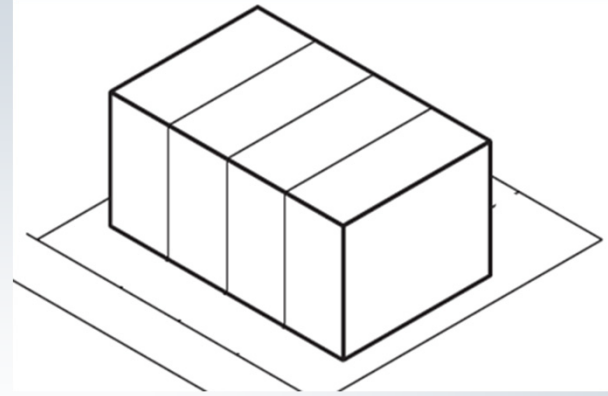
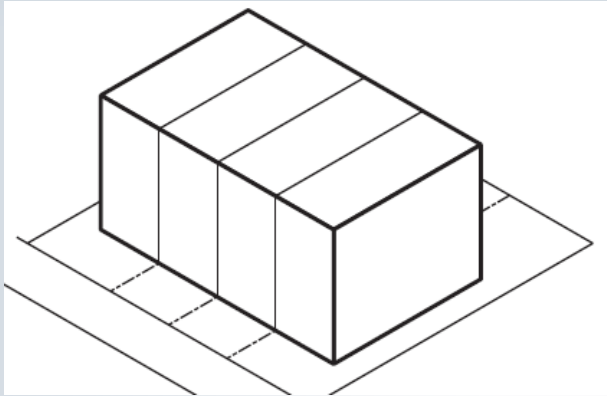

Attached Houses



Townhouses



Front Garage Limits: BHD-RIP Differences

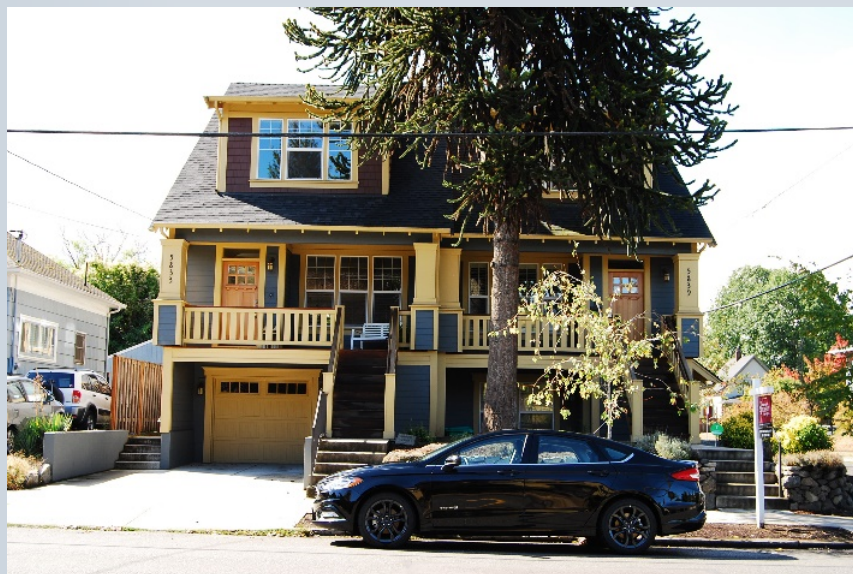

Calculation of 50% garage limit:

- **BHD**: Based on combined frontage of attached units for all housing types.
- **RIP**: As above for duplexes/triplexes/fourplexes, but calculated separately for each unit for attached houses.



Front Parking Limits: BHD-RIP Differences



Both limit front vehicle areas to 40% of frontage, but:

- **BHD**: Does not allow parking in front of front building line for any type of housing.
- **RIP**: Allows front parking for duplexes and triplexes, but not for fourplexes or narrow attached houses.



Front Parking Limits: BHD-RIP Differences



White doors above are for flex space, not garages



Other front parking examples, allowed by RIP (duplexes/triplexes), but not BHD.



Front Parking Limits: BHD-RIP Differences

Triplex examples:



Parking entirely in front of building

- Allowed by RIP, but not BHD



Front parking behind front building line

- Allowed by BHD and RIP



No off-street parking

- Allowed by BHD and RIP

Front parking limits for duplexes and triplexes:

- **BHD**: Not allowed between front building line and street.
- **RIP**: Allows front parking (as long as limited to 40% of frontage)

(see also next topic)



Front Parking Limits: BHD-RIP Differences

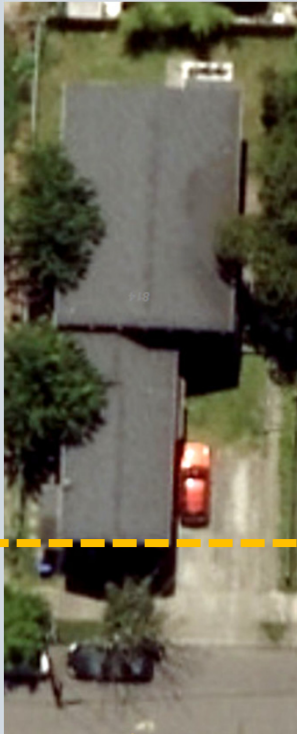

Front building line



Front of building



Front parking limits for duplexes and triplexes:

- **BHD:** Not allowed between front building line and street.
- **RIP:** Allows front parking (as long as limited to 40% of frontage)
(see also next topic)

Front Parking Limits: BHD-RIP Differences

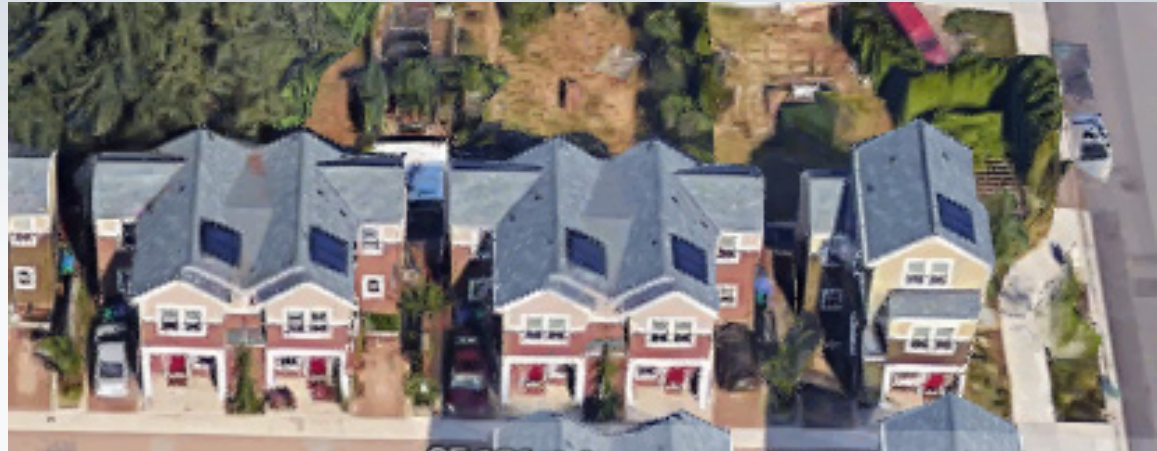

Differences in limiting front parking for attached houses:

- **BHD:** Does not allow parking between front building line and street, but can be to side of building front and in front of other portions of building.
- **RIP:** On narrow lots, parking prohibited between any portion of building and street (but allowed for duplexes/triplexes).



Front Parking Limits: BHD-RIP Differences



Differences in limiting front parking:

- **BHD:** Does not allow parking between front building line and street, but can be to side of building front and in front of other portions of building.
- **RIP:** On narrow lots, parking prohibited between any portion of building and street (but allowed for duplexes/triplexes).



Front Garages and Parking - Background

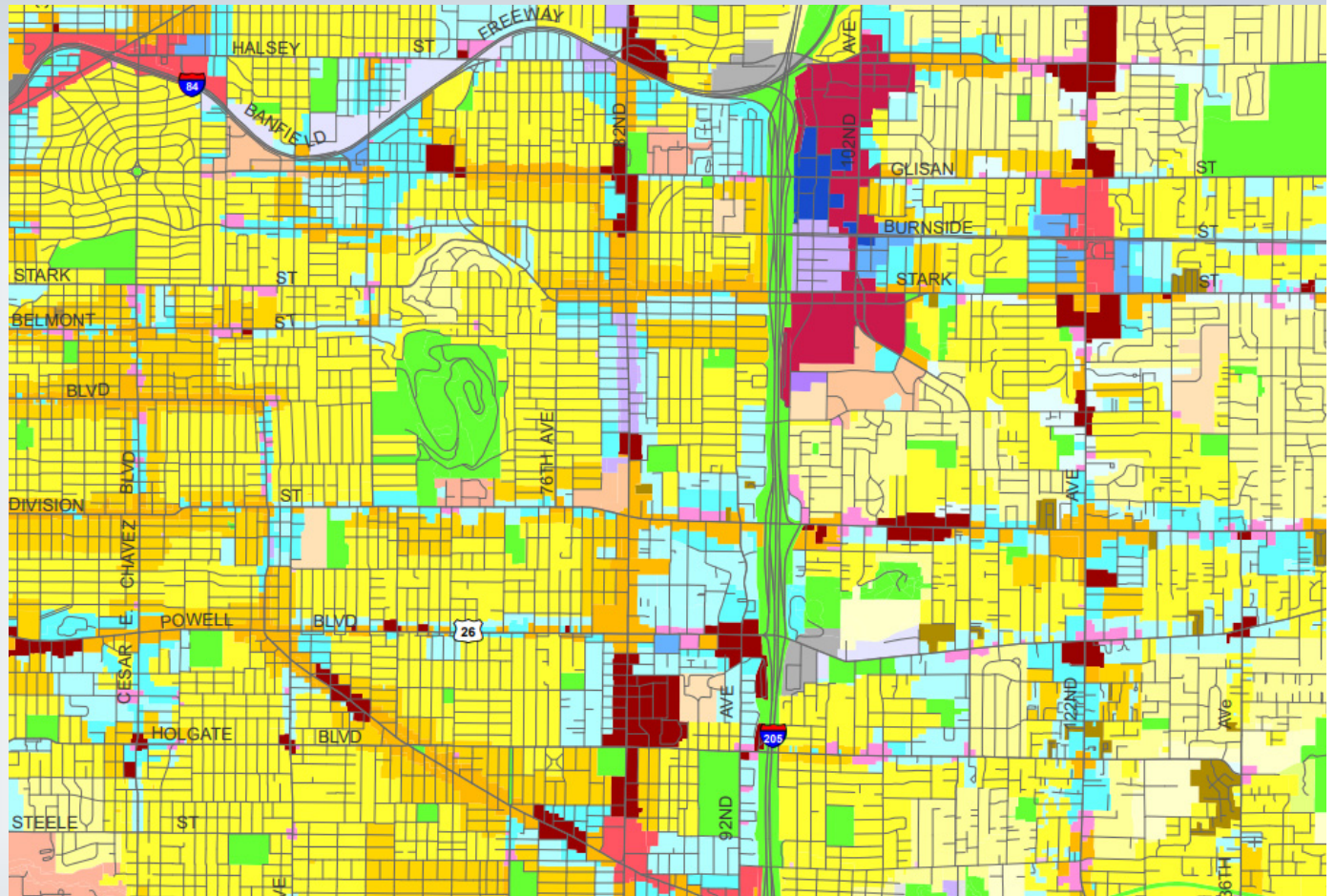

What is more important?

- Regulatory consistency based on housing type?
- Vary based on type of zone / location?



TOPIC 1: Front Garage Limitations



Base 50% garage limit on combined frontage?

- A. Allow for all housing types, including attached houses.
- B. Allow for all housing types, except attached houses.
- C. Both A and B (different approaches are fine).
- D. Never allow - limit garages to 50% of each attached unit, whether or not on separate lots.



TOPIC 2: Front Parking Limitations



Allow parking in front of buildings?

- A. Do not allow for any housing type.
- B. Allow for all housing types, except fourplexes and attached houses.
- C. Both A and B (different approaches are fine).
- D. Allow for all housing types (as long as no more than 40% of frontage).



TOPIC 3: Parking to Side of Front of Building



Allow parking to side of front building line (but in front of other portions of buildings)?

- A. Allow for all housing types, including attached houses.**
- B. Allow for all housing types, except attached houses.**
- C. Both A and B (different approaches are fine).**
- D. Never allow - no parking in front of any portion of buildings.**



Eastern Portland Deep Rear Setbacks



Update on Eastern Portland Deep Rear Setback Analysis



Eastern Portland Deep Rear Setbacks

Intent: Continue East Portland mid-block areas through requirements for deep rear setbacks

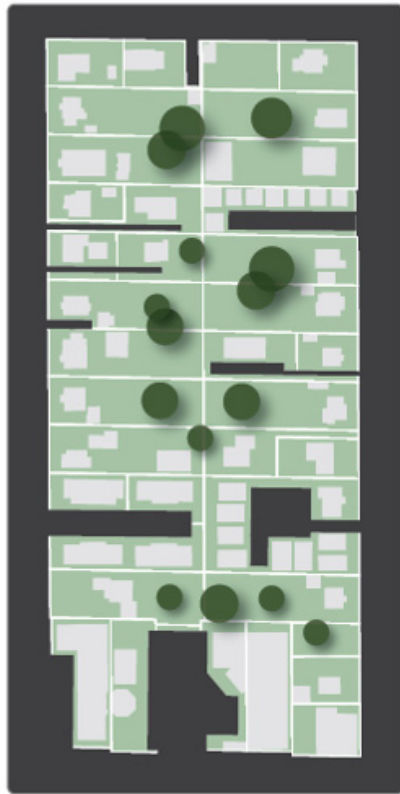

Existing



Continuation of current trends

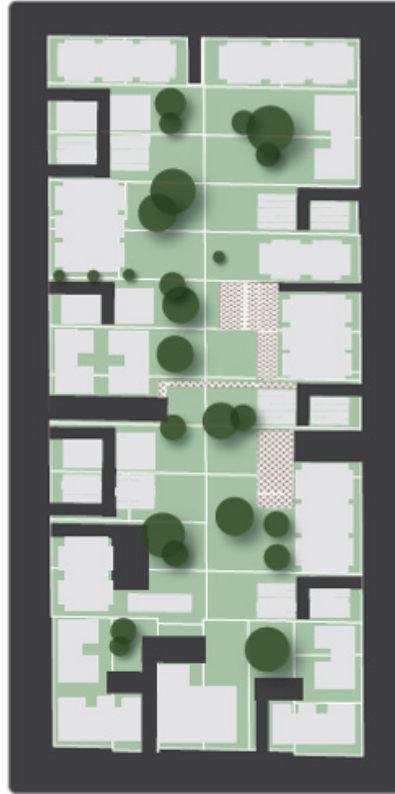

Mid-block open areas

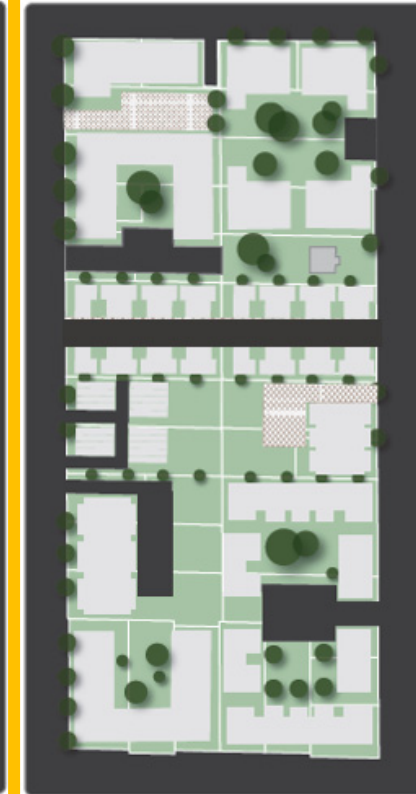

Mix of mid-block open areas and central courtyards

Exemptions for projects providing large centralized outdoor space or streets



Eastern Portland Deep Rear Setbacks

Intent: Continue East Portland mid-block areas through requirements for deep rear setbacks



Example of recent development



Example of 25% depth-of-site setback

Proposal:

Require rear setbacks equivalent to 25% of site depth



Eastern Portland Deep Rear Setbacks

- *At least 50% of setback must be landscaped.*
- *Rest can include parking or buildings with indoor common area.*
- *Exemptions for central open spaces, new street connections, corner sites, and sites less than 100' deep.*



Central courtyard (must be at least 10% of site area)



Eastern Portland Deep Rear Setbacks

- *At least 50% of setback must be landscaped.*
- *Rest can include parking or buildings with indoor common area.*
- *Exemptions for central open spaces, new street connections, corner sites, and sites less than 100' deep.*



Central courtyard

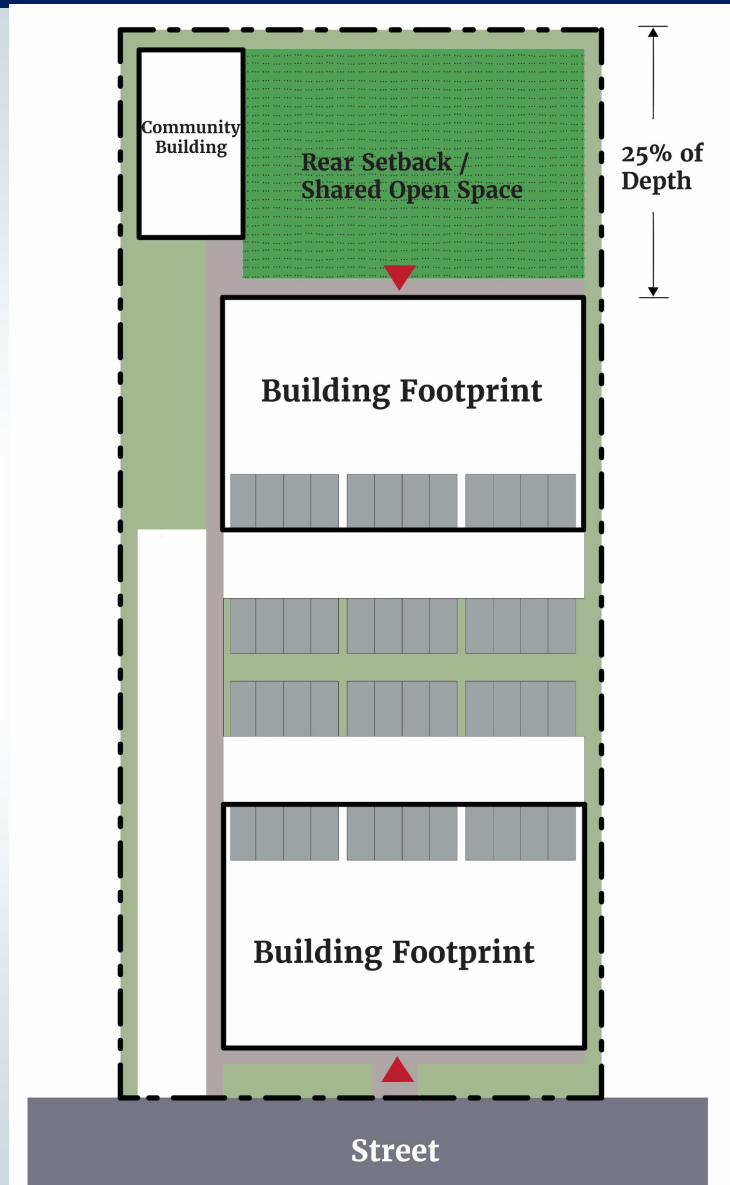

Eastern Portland Deep Rear Setbacks Analysis

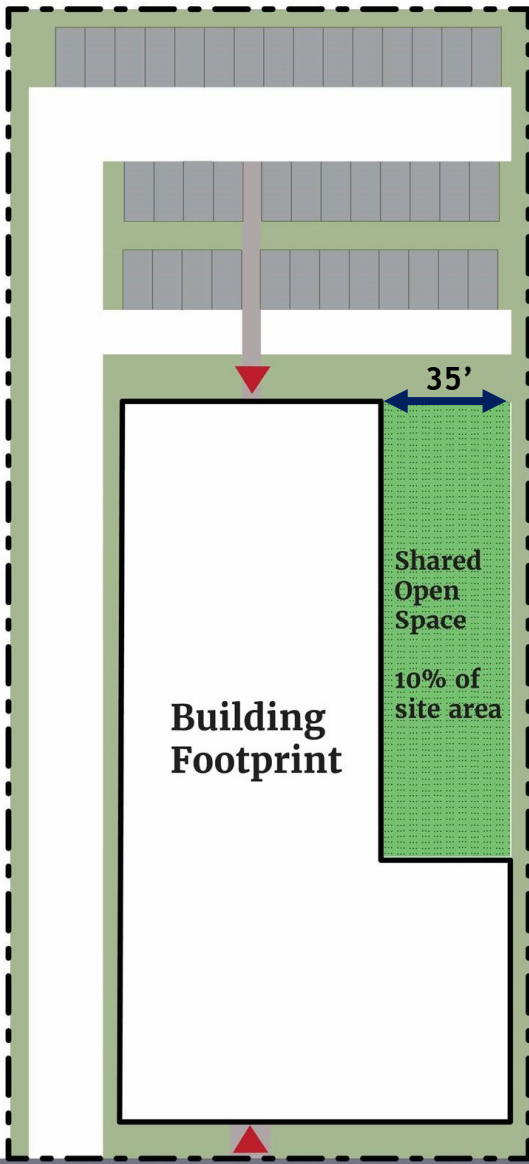

Street

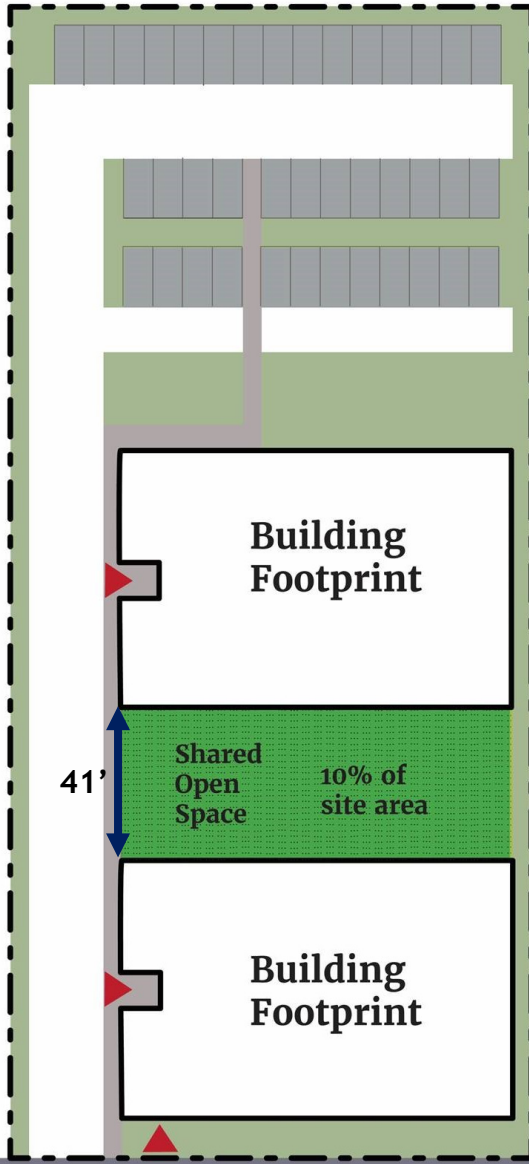

Street

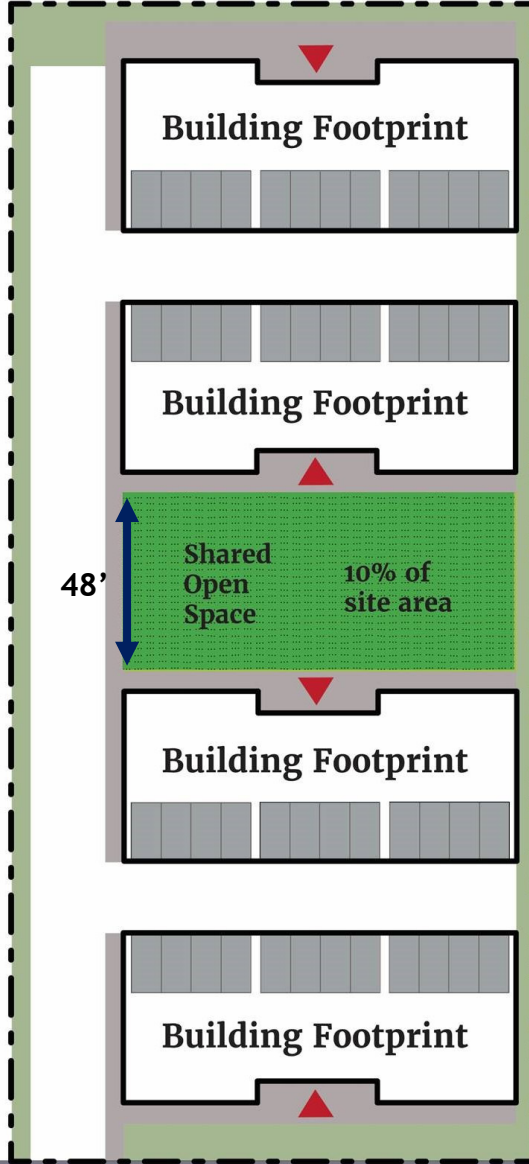

Street

Eastern Portland Deep Rear Setbacks Analysis



15%



10%



12%



10%

Examples in Eastern Portland that would meet the exemption for centralized common area (min. 10% of site area)



Development Bonus for Visitable Units

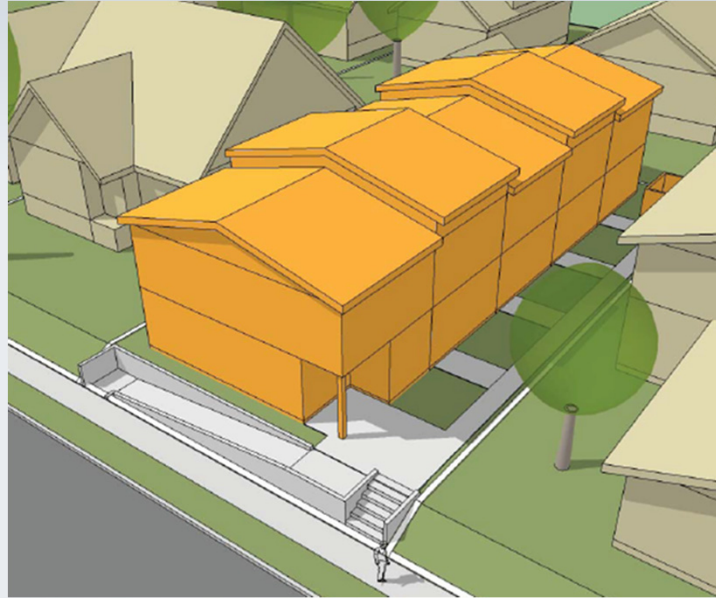

Staff Proposal:

- Provide a development bonus providing 25% additional FAR for projects providing visitable units.
- To qualify, at least 25% of units would need to be designed to meet visitability standards (same as RIP)



Bonus FAR Options

**Base
FAR**

+50%

+100%

Base FAR	Bonus FAR Up to 50% above base	Bonus FAR 100% above base
<ul style="list-style-type: none"> ▪ Allowed by right ▪ Varies by zone 	<ul style="list-style-type: none"> ▪ Inclusionary housing: full 50% bonus ▪ Moderate income family housing: 25% bonus (at least half of units must have 3 bedrooms affordable at 100% of MFI) ▪ Visitable units: 25% bonus (at least 25% of units must meet visitability standards) ▪ FAR transfers from sites preserving: <ul style="list-style-type: none"> ▪ Existing affordable housing ▪ Trees ▪ Historic resources 	<ul style="list-style-type: none"> ▪ Special bonus for deeper housing affordability (At least half of units must be affordable at 60% MFI)

New Multi-Dwelling Zones

New Zone: RM1
Current Zones: R2 and R3

Maximum Height: 35 feet
Max. Building Coverage: 50%

New Zone: RM2
Current Zone: R1

Maximum Height: 45 feet
Max. Building Coverage: 60%
(70% along major corridors)

New Zone: RM3
Current Zone: RH (2:1 FAR)

Maximum Height: 65 feet
Max. Building Coverage: 85%

New Zone: RM4
Current Zone: RH (4:1 FAR)

Maximum Height: 75 - 100 feet
Max. Building Coverage: 85%

Base FAR

Bonus FAR

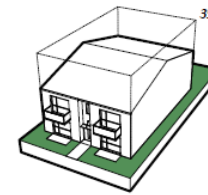

1 to 1

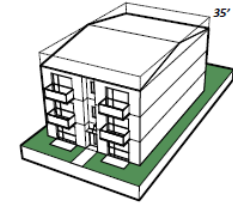

1.5 to 1



1.5 to 1



2.25 to 1

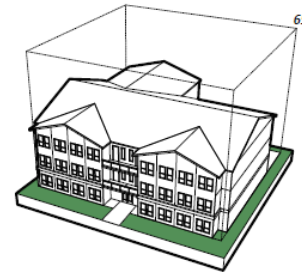

2 to 1

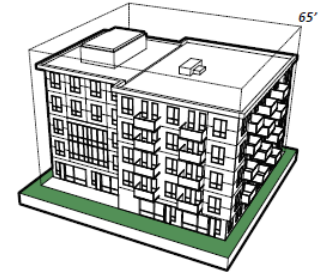

3 to 1

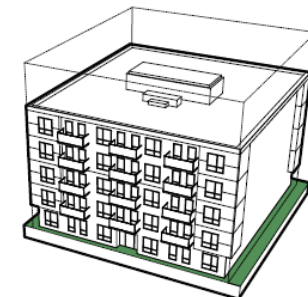

4 to 1

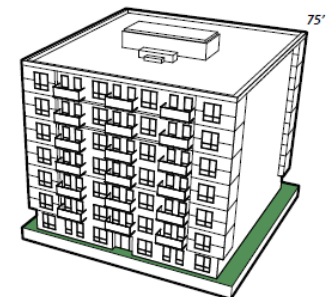

6 to 1



Remaining Work Sessions and Topics

November 13 (2 hours) – Work Session #3

- Historic district provisions (continued)
- Visitability

November 27 (2 hours) – Work Session #4

- Parking design
- Building and site design
- Setbacks

December 11 (2.5 hours) – Work Session #5

- Additional items related to reconciling BHD and RIP proposals
- Carry-over items from previous work sessions

April 9 (2 hours) – Recommendation

- Final reconciliation of decisions
- Vote on recommendation

(April 23rd is also scheduled, in case an additional session is needed)





Better Housing by Design:

An update to Portland's Multi-Dwelling Zoning Code

Work Session #5

Planning and Sustainability Commission

December 11, 2018



Bureau of Planning and Sustainability
Innovation. Collaboration. Practical Solutions.



Reference Slides



Front Garages and Parking - Background

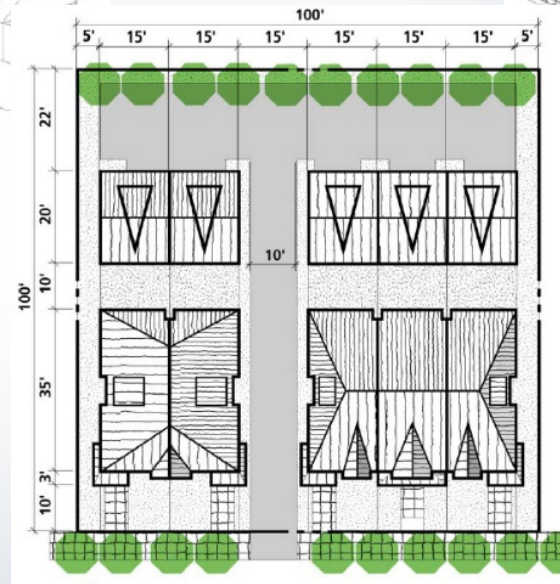
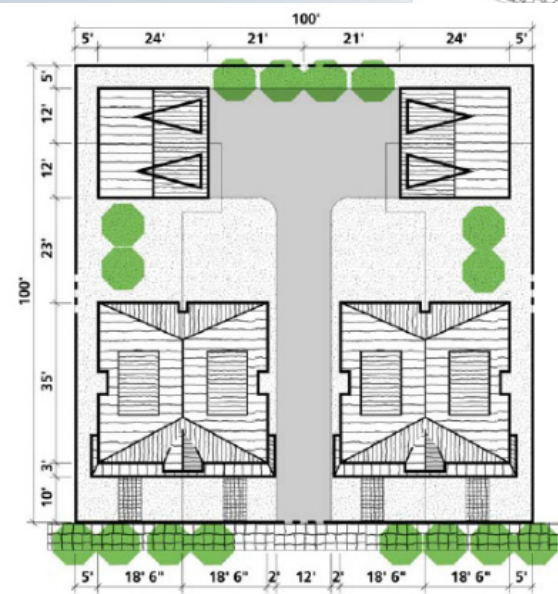
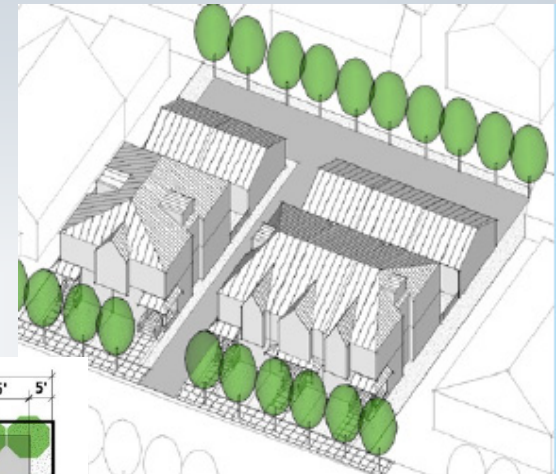
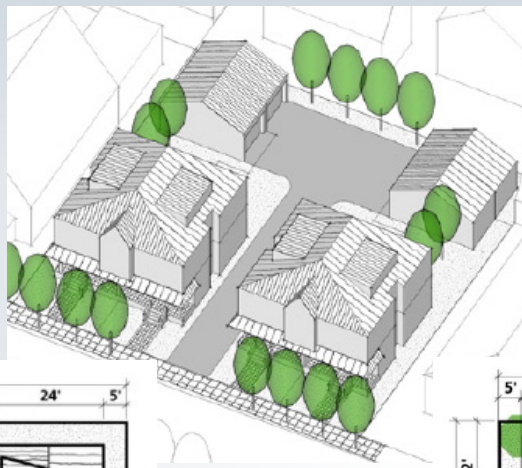

Rear
Parking

Examples of attached housing with rear or shared access parking.
In multi-dwelling zones, only the lowest allowed densities in the RM1 would allow for units wide enough to meet the 50% garage limit.



Front Garages and Parking - Background

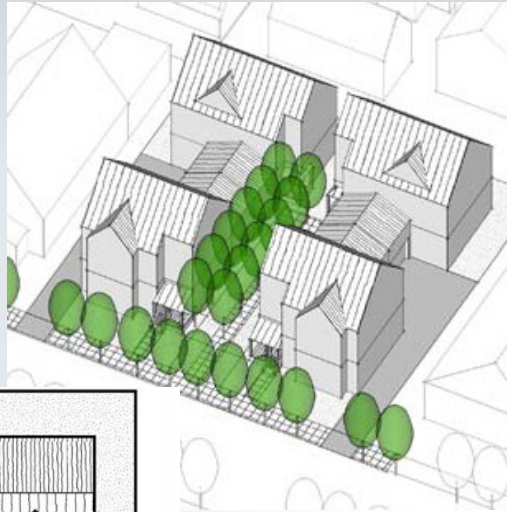

Units oriented to common greens, with rear parking

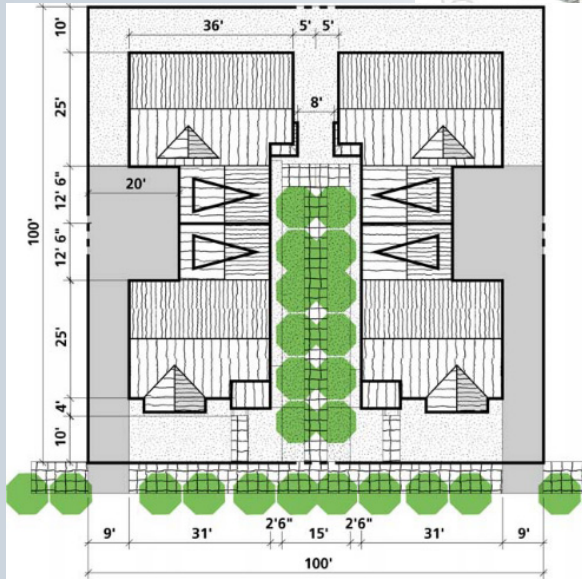

Examples of attached housing with rear or shared access parking.
In multi-dwelling zones, only the lowest allowed densities in the RM1 would allow for units wide enough to meet the 50% garage limit.

Front Garages and Parking - Background

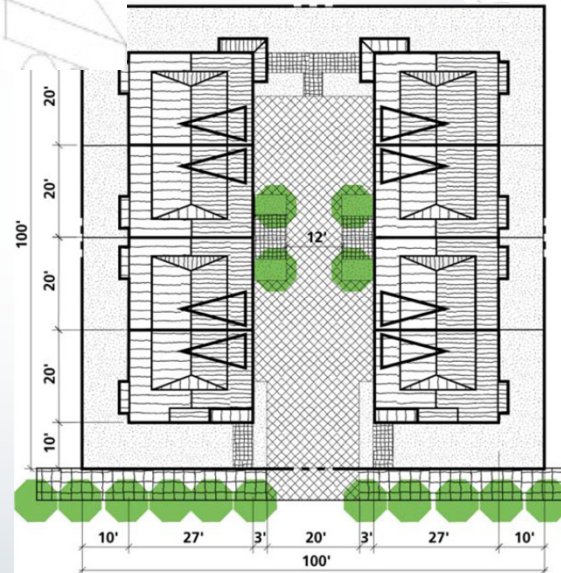
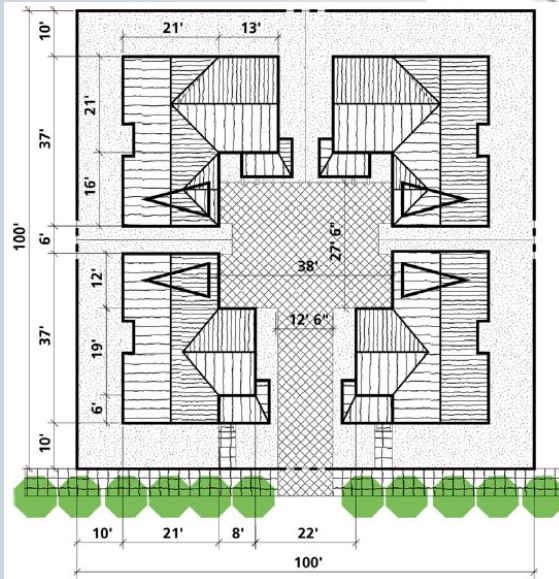
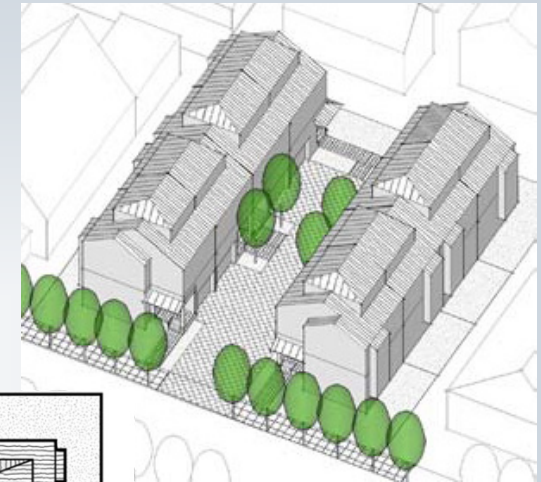

Shared
Courts

Examples of attached housing with rear or shared access parking.
In multi-dwelling zones, only the lowest allowed densities in the RM1 would allow for units wide enough to meet the 50% garage limit.



Front Garages and Parking - Background

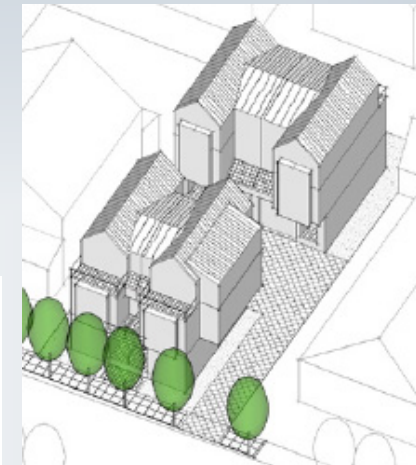
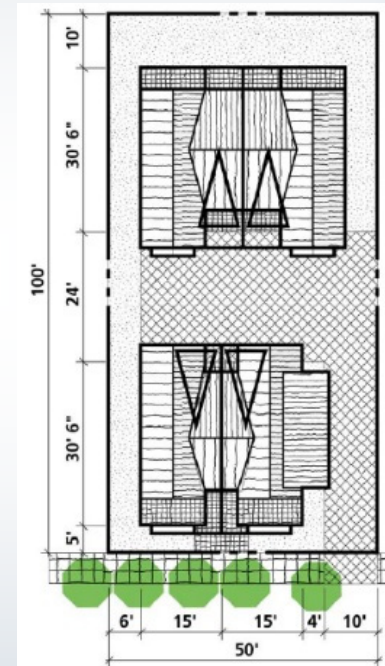
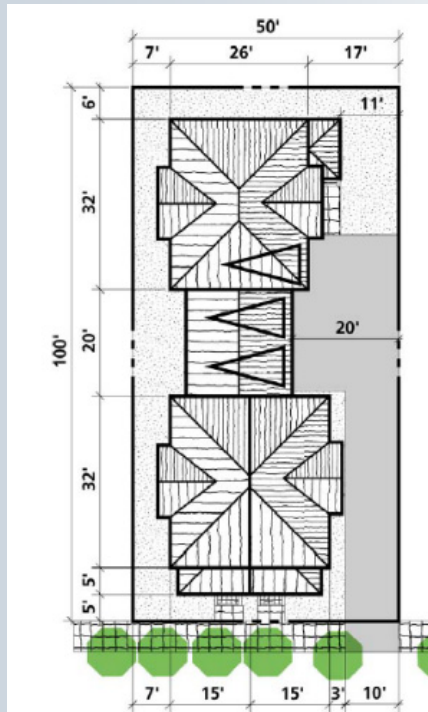

**3-4 units
on small lots**

Examples of attached housing with rear or shared access parking.
In multi-dwelling zones, only the lowest allowed densities in the RM1 would allow for units wide enough to meet the 50% garage limit.

Detached Houses - Background



Single-dwelling zones: 5' side setbacks



Historic detached houses on 25' lots

Multi-dwelling zones: 3' side setbacks

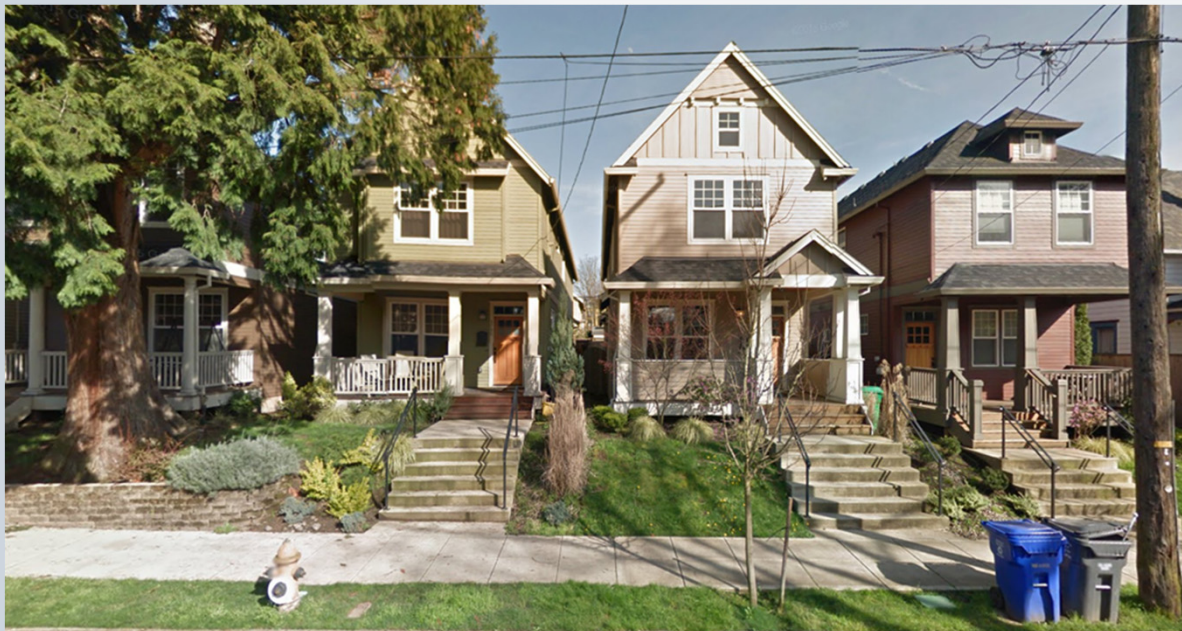

Differences in regulation of narrow lot detached houses

- BHD allows with min. lot width of **25'** - 3' side setbacks (allows wider houses)
- RIP allows with min. lot width of **26'** - 5' side setbacks



Parking pads - alternative to garages



PBOT requirements for shared driveways:

- Driveways for narrow lots (18'-28') must be combined into a 14' driveway approach at front property line.
- Driveways for other attached units must be paired (18'-20' driveway approach at front property line)

Intent is to preserve on-street parking

Figure 1
14' wide driveway approach

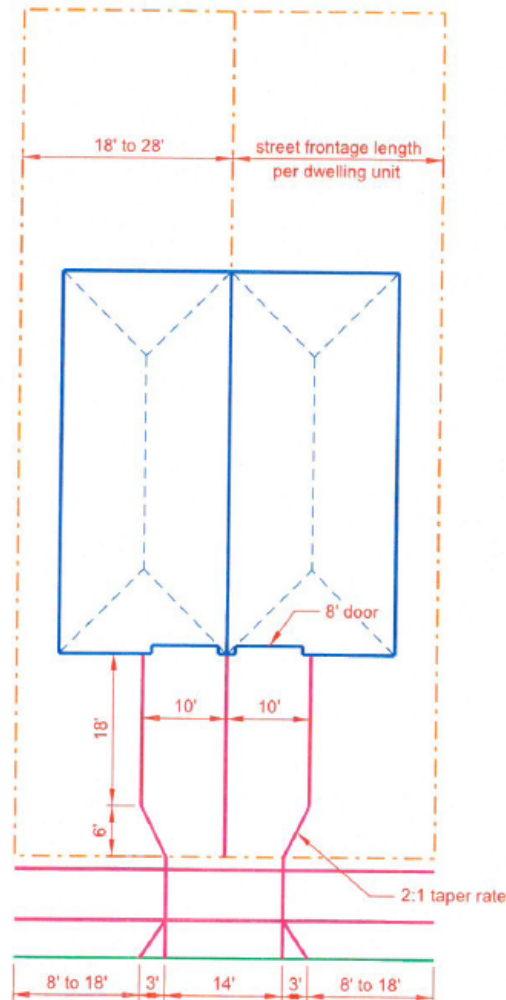

Figure 2
20' wide driveway approach

