

SSAN

WORK IN PUBLIC RIGHT - OF - WAY IS NOT APPROVED AS PART OF THIS BUILDING PERMIT

Plumbing Permit Required City of Portland Bureau of Development Services

INSTALL PLUMBING PRODUCTS APPROVED BY THE STATE PLUMBING BOARD OR APPROVED LISTING AGENCY

2014 Oregon Plumbing Specialty Code City of Portland ~ BDS

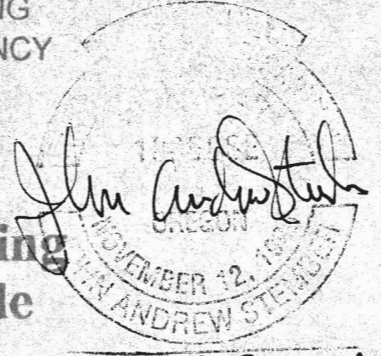

Premises-Isolation Backflow Protection Required by Water Quality Backflow (WQBF) Review (503-823-7480) Water Bureau Backflow Assembly Installation Requirements: www.portlandoregon.gov/water/backflowinstallationrequirements Title 21.12.320, 28.08.020 and/or OAR 333-061-0070, 333-061-0071. Plan Approved For Construction: Errors And Omissions Excepted.

DOMESTIC WATER SERVICE: Backflow Prevention Assemblies Must Conform to EPA Lead Free Requirements.

Reduced Pressure Backflow Assembly (RPBA) required. PROVISION FOR FULL RELIEF VALVE DISCHARGE MUST BE ACCOMMODATED.

Installation required on private property at property line on the centerline of the service, immediately adjacent to service connection.

Assembly must be 12" above finished grade and/or 100 year flood plain, whichever is greater.

Installation of a premise-isolation backflow assembly will create a closed system and may result in problems associated with thermal expansion. Installer responsible for making provisions for thermal expansion.

FIRE LINE WATER SERVICE:

Double Check Detector Assembly (DCDA) required. Must be installed on private property at the property line on the centerline of the service, immediately adjacent to service connection.

86 UNITS TOTAL

7706 4 UNITS	7708 4 UNITS	7710 6 UNITS
-----------------	-----------------	-----------------

PI DCDA - PREMISES ISOLATION (PI) DOUBLE CHECK DETECTOR ASSEMBLY (DCDA) TO BE INSTALLED PER WATER BUREAU STANDARDS

PI DCVA - PREMISES ISOLATED (PI) DOUBLE CHECK VALVE ASSEMBLY (NOT USED) TO BE INSTALLED PER WATER BUREAU STANDARDS

PI RPBA - PREMISES ISOLATED (PI) REDUCED PRESSURE BACKFLOW ASSEMBLY (PPBA) TO BE INSTALLED PER WATER BUREAU STANDARDS

NEW WATERLINE TO BE 5'0" FROM (E) PGE LINE

No Mandatory Plumbing Plan Review Required OAR 918-780-0040

APPLICANT / PERMITTEE IS RESPONSIBLE FOR PROPER REPAIR OR REPLACEMENT OF ANY PORTION OF THE RIGHT - OF - WAY DAMAGED OR IN ANY MANNER ALTERED FROM ITS ORIGINAL CONDITION

NEW PIRPBA AT PROPERTY LINE CENTERED ON WATER LINE EXISTING 2" LINE

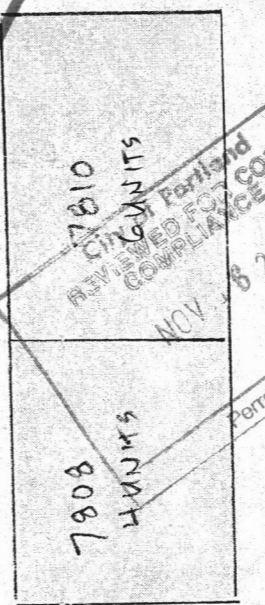
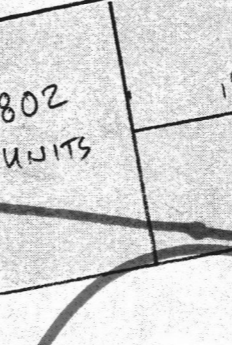
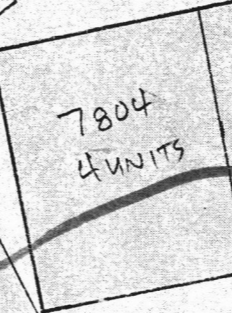
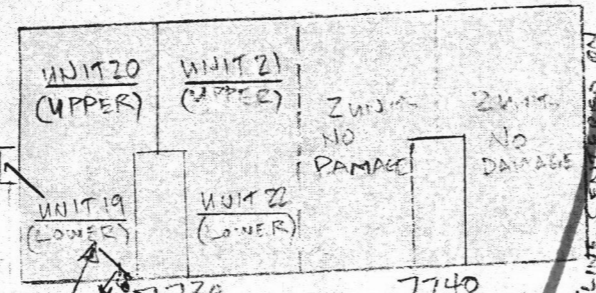
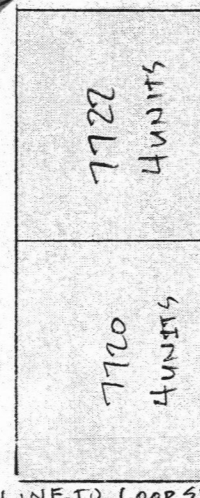
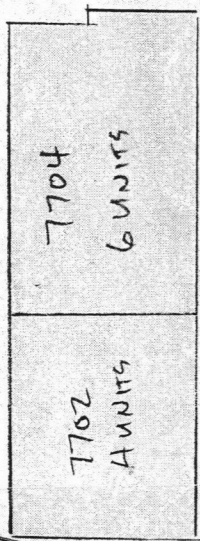

UNIT 20 (UPPER) UNIT 21 (UPPER) 2 UNITS NO DAMAGE 2 UNITS NO DAMAGE

UNIT 19 (LOWER) UNIT 22 (LOWER)

(H) FIRE DAMAGED UNIT (AND WATER)

NEW 2" PGE SPRINGLINE SERVICE FROM 8" DCI WATER LINE

NEW PI DCDA AT PROPERTY LINE CENTERED ON EXISTING 2" LINE

NEW 2" PGE SPRINGLINE SERVICE FROM 8" DCI WATER LINE

NEW 2" PGE SPRINGLINE SERVICE FROM 8" DCI WATER LINE

NEW PIRPBA AT PROPERTY LINE CENTERED ON EXISTING 2" LINE

SITE PLAN NTS

EXISTING WATER FACTOR

(E) MAIL BOXES

STREET TREES NOT REQUIRED AT THIS TIME

(E) NO PARKING SIGN

SCALES NOTED ON DRAWINGS ARE FOR 11"X17" SHEET. SCALE ACCORDINGLY FOR DIFFERENT SIZE SHEET.

RECEIVED NOV 03 2017 BDS DOCUMENT SERVICES

City of Portland Bureau of Development Services. By [Signature] Date 11.8.17 Approved by Planning and Zoning Review

1419 Washington St. Suite 100 Oregon City, Oregon 97045 Work: 503-657-9800 Cell: 503-449-3080 Andy@jasenginc.com



GABRIEL PARK APART. FIRE RESTORATION HARBRO 7740 SW 45TH AVE, PORTLAND, OR 97219

COPYRIGHT 2017 JAS ENGINEERING	JAS	DAS	17-024	5/8/2017
DESIGN BY:	JAS	DAS		
DRAWN BY:				
JAS PROJ. NO.:				
ISSUE DATE:				

SHEET TITLE: SITE PLAN
SHEET NO: C-1.0

17-186097-0

- 1 Contractor to Field verify all dimensions, roof pitch, roof overhangs and barge rafter extensions.
- 2 Contractor to match existing siding type for all fire damaged areas on the residence.
- 3 Contractor to coordinate exact new door and window sizes with framed rough openings prior to ordering and installing new units.
- 4 Provide house wrap under any new siding areas.
- 5 Roof to be Modified Bitumen roofing, Thermoset Single Ply roofing or Thermoplastic Single Ply roofing on the minimum ¼ in 12 slope

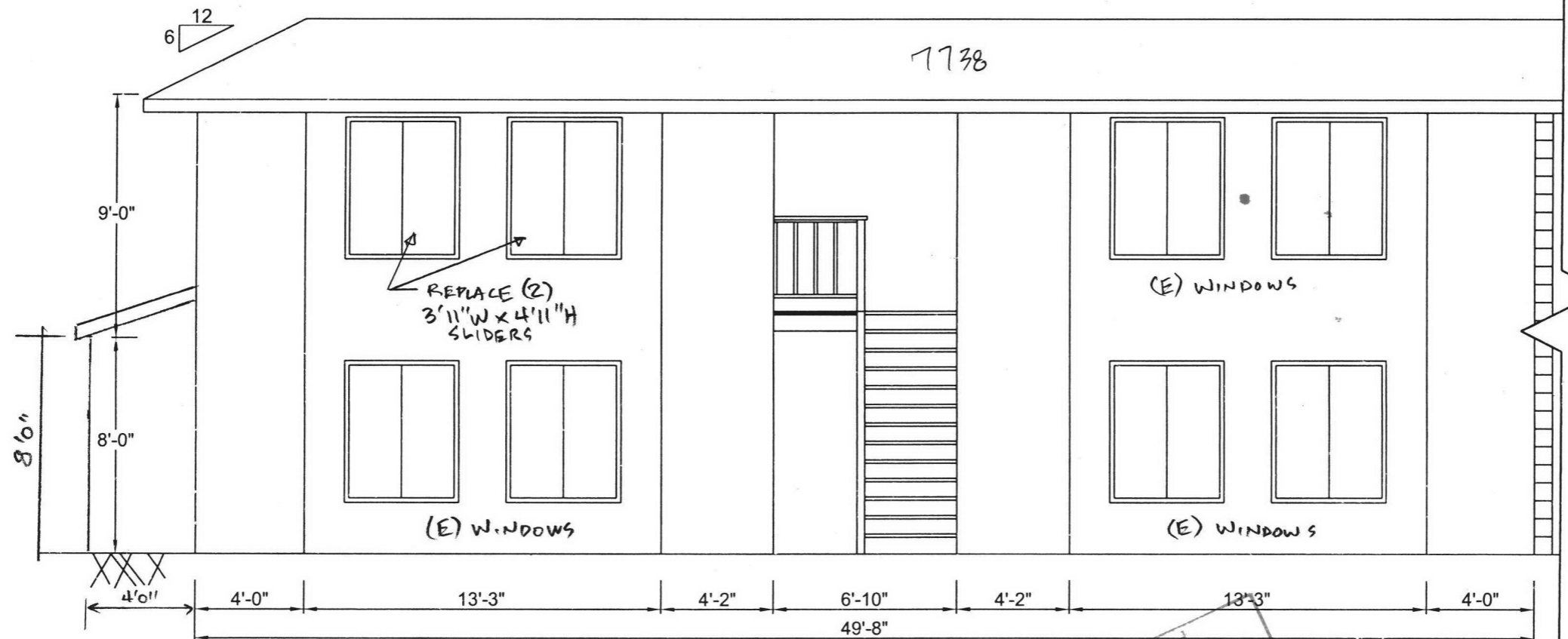

EXPIRES: 6-30-2018
6-8-17

RECEIVED
AUG 08 17
BDS
DOCUMENT SERVICES

1419 Washington St,
Suite 100
Oregon City, Oregon 97045
Work: 503-657-9800
Cell: 503-449-3080
Andy@jasenginc.com



GABRIEL PARK APART. FIRE RESTORATION
HARBRO
7740 SW 45TH AVE,
PORTLAND, OR 97219

City of Portland
REVIEWED FOR CODE
COMPLIANCE
NOV 16 2017
Permit Number

SEE A-1.4
FOR CODE STUDY

**CONTRACTOR TO FIELD
VERIFY ALL DIMENSIONS**

City of Portland
Bureau of
Development Services
By *[Signature]* Date 11.8.17
Approved by
Planning and Zoning Review

FRONT ELEVATION

3/16" = 1'-0"

SCALES NOTED ON DRAWINGS ARE FOR
11"X17" SHEET. SCALE ACCORDINGLY
FOR DIFFERENT SIZE SHEET.

COPYRIGHT 2017 JAS ENGINEERING	DESIGN BY: JAS	DRAWN BY: DAS	JAS PROJ. NO: 17-024	ISSUE DATE: 5/6/2017
-----------------------------------	----------------	---------------	----------------------	----------------------

SHEET TITLE: FRONT ELEVATION	
SHEET NO: A-1.1	

- 1 Contractor to Field verify all dimensions, roof pitch, roof overhangs and barge rafter extensions.
- 2 Contractor to match existing siding type for all fire damaged areas on the residence.
- 3 Contractor to coordinate exact new door and window sizes with framed rough openings prior to ordering and installing new units.
- 4 Provide house wrap under any new siding areas.
- 5 Roof to be Modified Bitumen roofing, Thermoset Single Ply roofing or Thermoplastic Single Ply roofing on the minimum ¼ in 12 slope

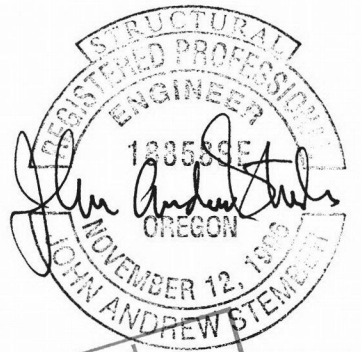
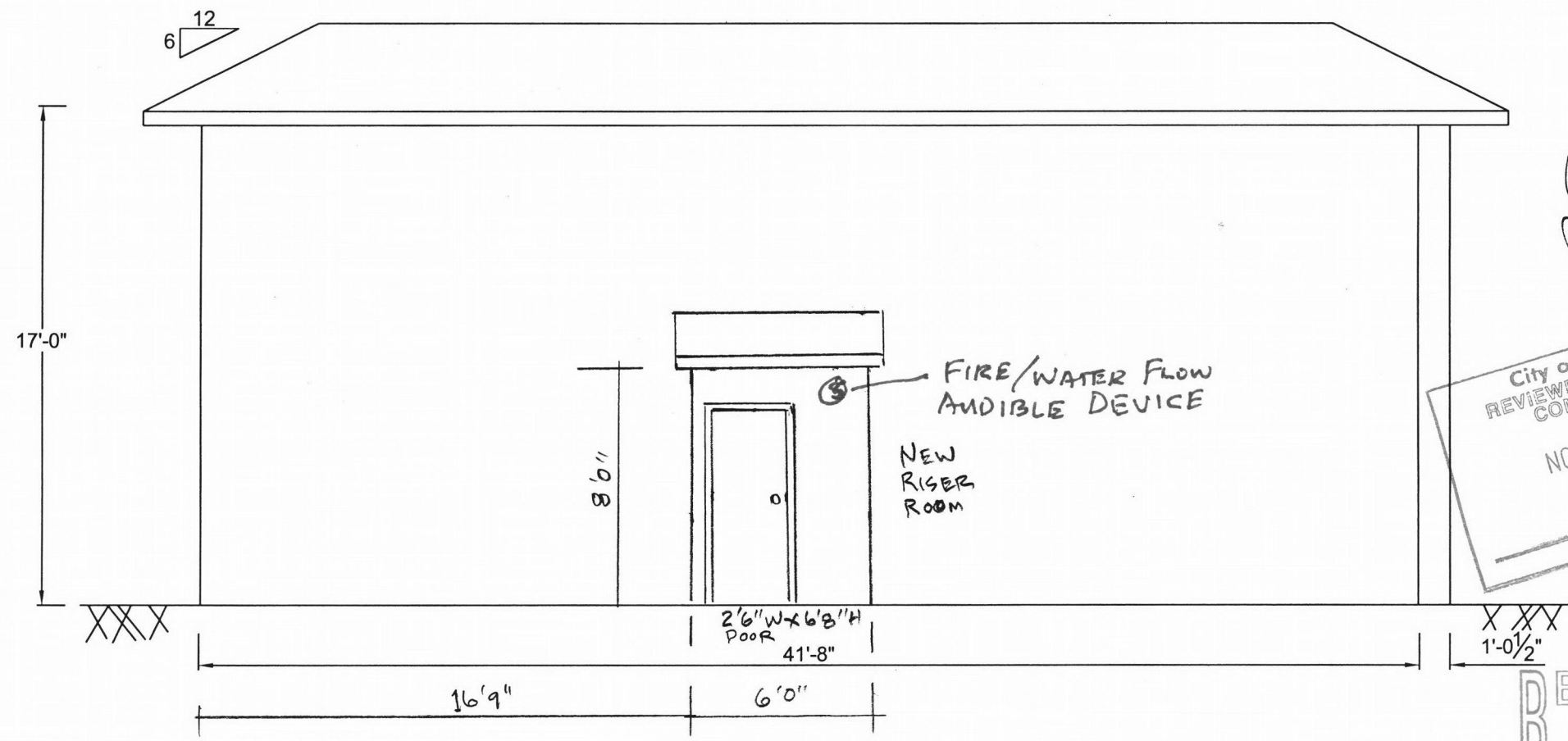

City of Portland
 REVIEWED FOR COMPLIANCE
 NOV 16 2017
 EXPIRES 6-30-2018
 6-7-17
 Permit Number

RECEIVED
 AUG 08 2017

BDS
 DOCUMENT SERVICES

City of Portland
 Bureau of
 Development Services
 By *[Signature]* Date 11.8.17
 Approved by
 Planning and Zoning Review

LEFT ELEVATION
 3/16" = 1'-0"

**CONTRACTOR TO FIELD
 VERIFY ALL DIMENSIONS**

SCALES NOTED ON DRAWINGS ARE FOR
 11"X17" SHEET. SCALE ACCORDINGLY
 FOR DIFFERENT SIZE SHEET.

1419 Washington St.
 Suite 100
 Oregon City, Oregon 97045
 Work: 503-657-9800
 Cell: 503-449-3080
 Andy@jasenginc.com



GABRIEL PARK APART. FIRE RESTORATION
 HARBRO
 7740 SW 45TH AVE,
 PORTLAND, OR 97219

COPYRIGHT 2017 JAS ENGINEERING	DESIGN BY:	JAS	DAS	17-024
	DRAWN BY:	JAS	DAS	17-024
JAS PROJ. NO.:		17-024		
ISSUE DATE:		5/8/2017		

SHEET TITLE:
**LEFT
 ELEVATION**
 SHEET NO.
A-1.2

1. Contractor to Field verify all dimensions, roof pitch, roof overhangs and barge rafter extensions.
2. Contractor to match existing siding type for all fire damaged areas on the residence.
3. Contractor to coordinate exact new door and window sizes with framed rough openings prior to ordering and installing new units.
4. Provide house wrap under any new siding areas.
5. Roof to be Modified Bitumen roofing, Thermoset Single Ply roofing or Thermoplastic Single Ply roofing on the minimum ¼ in 12 slope.

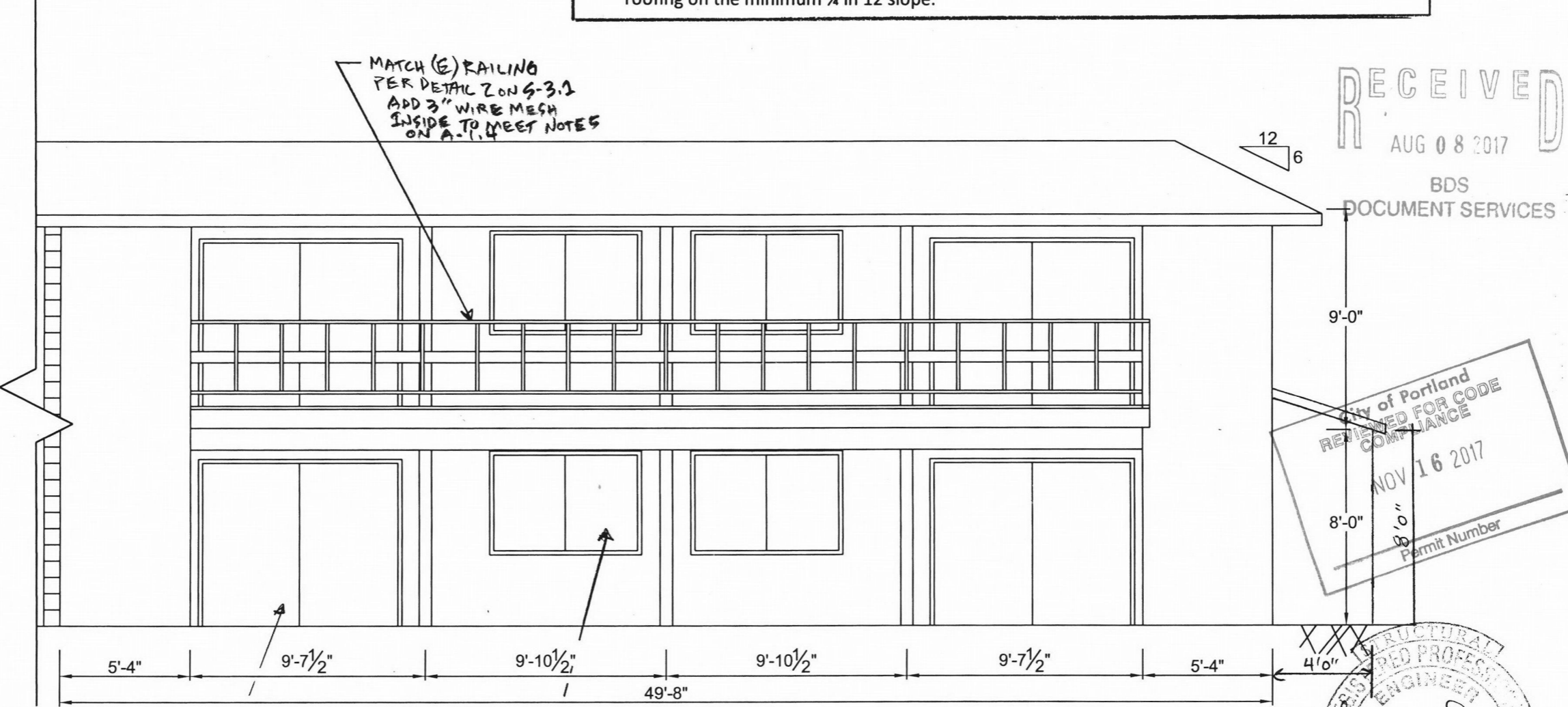

RECEIVED
AUG 08 2017

BDS
DOCUMENT SERVICES

City of Portland
REVIEWED FOR CODE
COMPLIANCE
NOV 16 2017
Permit Number

PROFESSIONAL
REGISTERED PROFESSIONAL
ENGINEER
1835833
NOVEMBER 12, 1998
JOHN ANDREW STEINER

EXPIRE 6-30-2018
6-8-17

City of Portland
Bureau of
Development Services
By *[Signature]* Date 11.8.17
Approved by
Planning and Zoning Review

REAR ELEVATION
3/16" = 1'-0"

SCALES NOTED ON DRAWINGS ARE FOR
11"X17" SHEET. SCALE ACCORDINGLY
FOR DIFFERENT SIZE SHEET.

1419 Washington St,
Suite 100
Oregon City, Oregon 97045
Work: 503-657-9800
Cell: 503-449-3080
Andy@jasenginc.com



GABRIEL PARK APART. FIRE RESTORATION
HARBRO
7740 SW 45TH AVE,
PORTLAND, OR 97219

COPYRIGHT 2017 JAS ENGINEERING	DESIGN BY:	JAS	DAS	ISSUE DATE: 5/8/2017
	DRAWN BY:	JAS	DAS	
JAS PROJ. NO.:		17-024		

SHEET TITLE:
**REAR
ELEVATION**

SHEET NO.:
A-1.3

**CONTRACTOR TO FIELD
VERIFY ALL DIMENSIONS**

- ⑤ 1. Smoke/carbon monoxide detectors are required in each sleeping room and outside each sleeping room and on each level. They must be interconnected with battery backup
- ⑥ 2. Vent fans exhausting to the outside are required at each new bathroom, laundry room and for the kitchen hood.
- 3. Provide R15 in (E) 2x4 walls, R-38 in flat ceiling areas. Doors to be U=0.20 and windows to be SHGC=0.40 for all replacement doors and windows. (GLAZING PERFORMANCE SHGC=0.40)
- 4. Egress Windows in each sleeping room to be 5.7 sqft with minimum 24" height, 20" width and clear opening maximum 44" above finished floor.
- 5. Guards not less than 36" in height are required at the open edge of porches or raised floor surfaces greater than 30" above the floor or grade below. They shall have intermediate rails or ornamental closures that do not allow the passage of a 4" sphere or more in diameter.
- 6. Safety glazing is required in doors and all glazing with in 24" of either edge of the door in a closed position. Safety glazing is also required in windows adjacent to bathtubs and showers.
- 7. Additional Measures per Table N1101.3 are not required as this is just a fire restoration and there is no change to the footprint.

**SECTION 420
GROUPS I-1, R-1, R-2, R-3**

420.1 General. Occupancies in Groups I-1, R-1, R-2, R-3 and R-4 shall comply with the provisions of Sections 420.1 through 420.6 and other applicable provisions of this code.

420.2 Separation walls. Walls separating *dwelling units* in the same building, walls separating *sleeping units* in the same building and walls separating *dwelling* or *sleeping units* from other occupancies contiguous to them in the same building shall be constructed as *fire partitions* in accordance with Section 708.

420.3 Horizontal separation. Floor assemblies separating *dwelling units* in the same buildings, floor assemblies separating *sleeping units* in the same building and floor assemblies separating *dwelling* or *sleeping units* from other occupancies contiguous to them in the same building shall be constructed as *horizontal assemblies* in accordance with Section 711.

**SECTION 1207
SOUND TRANSMISSION**

1207.1 Scope. This section shall apply to common interior walls, partitions and floor/ceiling assemblies between adjacent *dwelling units* or between *dwelling units* and adjacent public areas such as halls, *corridors*, *stairs* or service areas.

1207.2 Air-borne sound. Walls, partitions and floor/ceiling assemblies separating *dwelling units* from each other or from public or service areas shall have a sound transmission class (STC) of not less than 50 (45 if field tested) for air-borne noise when tested in accordance with ASTM E 90. Penetrations or openings in construction assemblies for piping; electrical devices; recessed cabinets; bathtubs; soffits; or heating, ventilating or exhaust ducts shall be sealed, lined, insulated or otherwise treated to maintain the required ratings. This requirement shall not apply to *dwelling unit* entrance doors; however, such doors shall be tight fitting to the frame and sill.

1207.2.1 Masonry. The sound transmission class of concrete masonry and clay masonry assemblies shall be calculated in accordance with TMS 0302 or determined through testing in accordance with ASTM E 90.

1207.3 Structure-borne sound. Floor/ceiling assemblies between *dwelling units* or between a *dwelling unit* and a public or service area within the structure shall have an impact insulation class (IIC) rating of not less than 50 (45 if field tested) when tested in accordance with ASTM E 492.

Code Summary

Residential Group R-2
8-Unit Apartment House
Construction Type – V-B
Table 503 – 2-Story Maximum
Allowable Height 40'
Allowable Area 7,000 sf (may be increased for multi-story and separations)

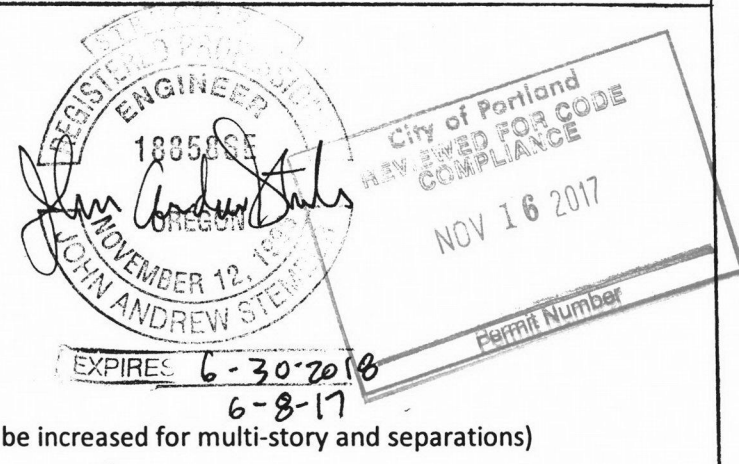

903.2.8.5 – Sprinkler System Not Required Throughout 13R System (when less than 50% of Units are substantially damaged). An NFPA 13R system is required in only the substantially damaged dwelling units as defined in Chapter 2 (Greater than 25% of the assessed value). This is required in upper Units 20 & 21 only for this project as determined by analysis.

ON A SEPARATE PERMIT

The NFPA 13R System for Units 20 & 21 will be provided as a ~~deferred submittal~~. A fire department connection is not required. The sprinkler system will also provide coverage for the Units 20 and 21 balcony in accordance with Section 903.3.1.2.1.

- 903.4.2 SEE BELOW
- 708 – 1-hr Fire Partition is required between each unit
- 711 – 1-hr Horizontal assembly is required between each unit
- 1207 – STC 50 Listed Assembly is required at each wall and floor/ceiling between units
- 718.3 – Draft-stopping is required at the floor between each unit
- 718.4 – Draft-stopping is required between each 2-Units in the Attic Space



- 1. Contractor to Field verify all dimensions, roof pitch, roof overhangs and barge rafter extensions.
- 2. Contractor to match existing siding type for all fire damaged areas on the residence.
- 3. Contractor to coordinate exact new door and window sizes with framed rough openings prior to ordering and installing new units.
- 4. Provide house wrap under any new siding areas.
- 5. Roof to be Modified Bitumen roofing, Thermoset Single Ply roofing or Thermoplastic Single Ply roofing on the minimum ¼ in 12 slope.

PFC 903.4.2 ALARMS. AN APPROVED AUDIBLE DEVICE LOCATED ON THE EXTERIOR OF THE BUILDING IN AN APPROVED LOCATION, SHALL BE CONNECTED TO EACH AUTOMATIC SPRINKLER SYSTEM.

1419 Washington St.
Suite 100
Oregon City, Oregon 97045
Work: 503-657-9800
Cell: 503-449-3080
Andy@jasenginc.com



GABRIEL PARK APART. FIRE RESTORATION
HARBRO
7740 SW 45TH AVE,
PORTLAND, OR 97219

COPYRIGHT 2017 JAS ENGINEERING	DESIGN BY:	JAS
	DRAWN BY:	DAS
	JAS PROJ. NO.:	17-024
	ISSUE DATE:	5/8/2017

SHEET TITLE:	CODE SUMMARY
SHEET NO.:	A-1.4

SCALES NOTED ON DRAWINGS ARE FOR 11"X17" SHEET. SCALE ACCORDINGLY FOR DIFFERENT SIZE SHEET.

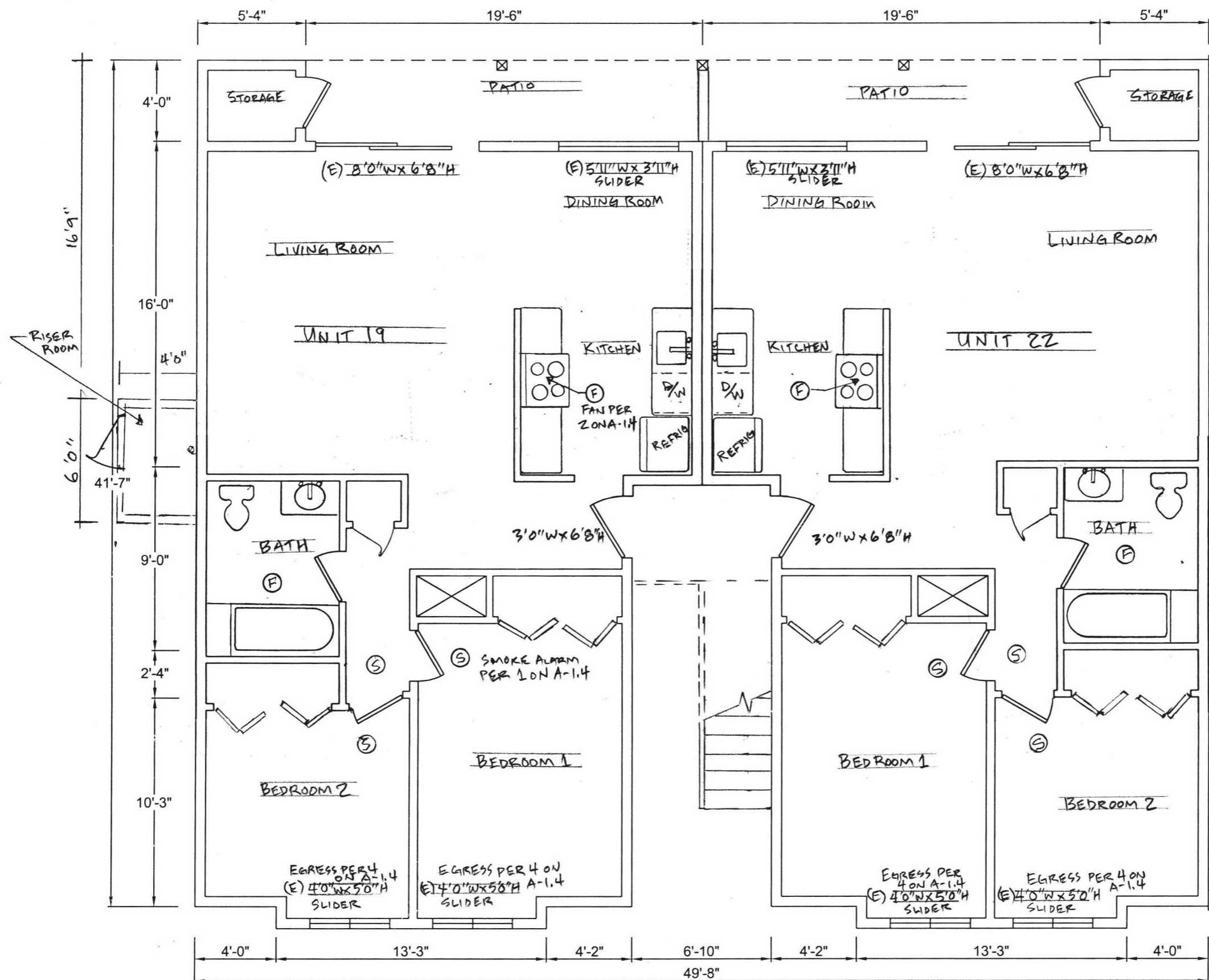

**CONTRACTOR TO FIELD
VERIFY ALL DIMENSIONS**

MAIN LEVEL FLOOR PLAN

$\frac{3}{16}'' = 1'-0''$

SCALES NOTED ON DRAWINGS ARE FOR
11"X17" SHEET. SCALE ACCORDINGLY
FOR DIFFERENT SIZE SHEET.



EXPIRES 6-30-2016
6-8-17

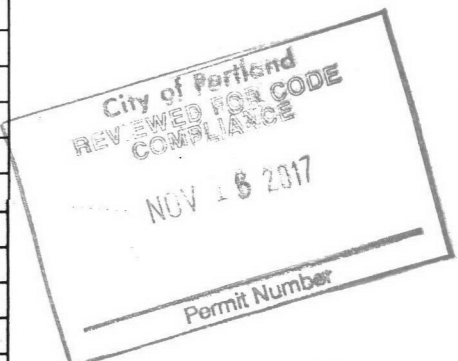

RECEIVED
AUG 08 2017
BDS
DOCUMENT SERVICES

1419 Washington St.
Suite 100
Oregon City, Oregon 97045
Work: 503-657-9800
Cell: 503-449-3080
Andy@jasenginc.com



GABRIEL PARK APART. FIRE RESTORATION
HARBRO
7740 SW 45TH AVE,
PORTLAND, OR 97219

COPYRIGHT 2017 JAS ENGINEERING	DESIGN BY: JAS	JAS PROJ. NO.: 17-024	ISSUE DATE: 5/8/2017
	DRAWN BY: DAS		

SHEET TITLE: MAIN LEVEL FLOOR PLAN
SHEET NO: A-2.1a

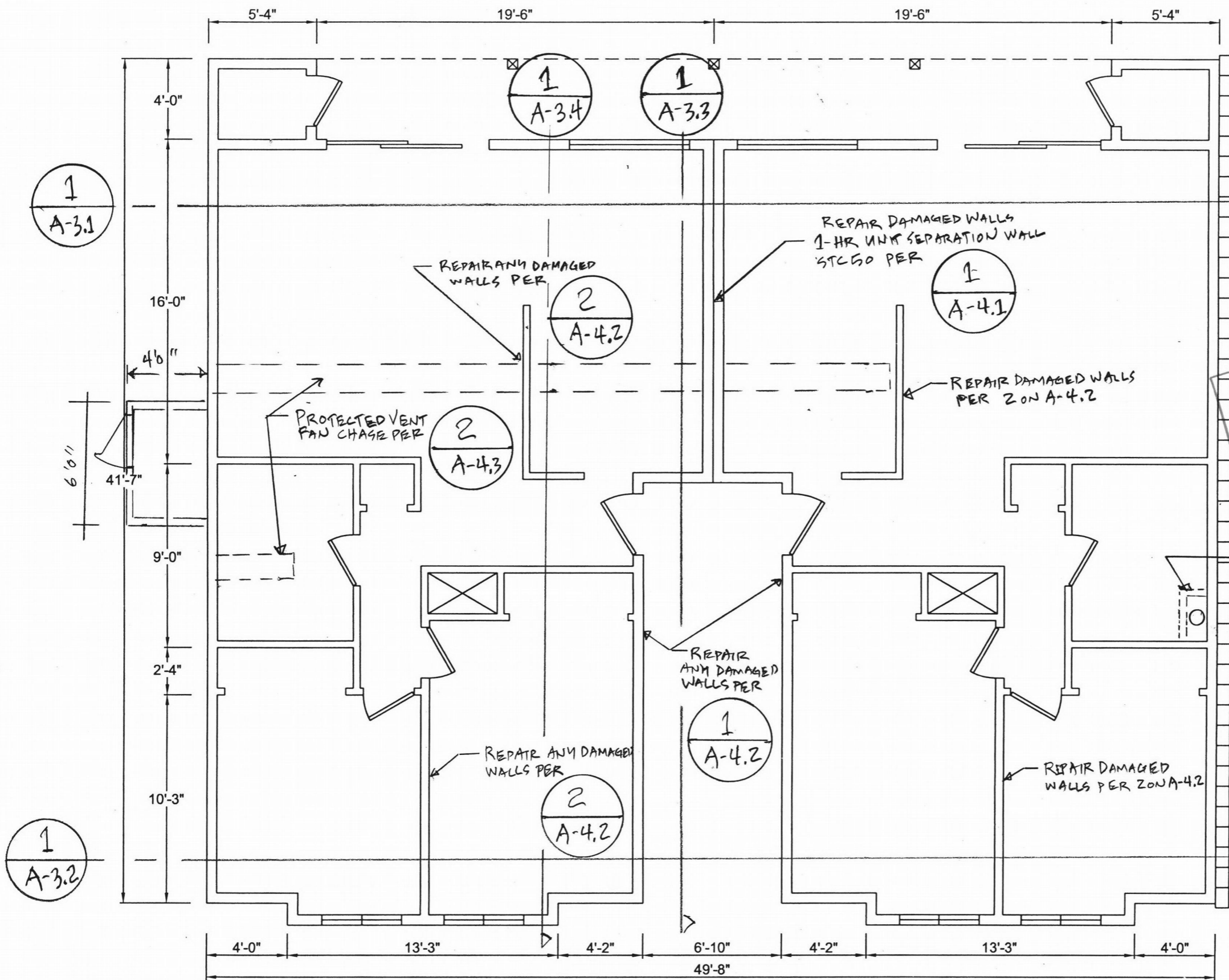

EXPIRES 6-30-2018
6-8-17

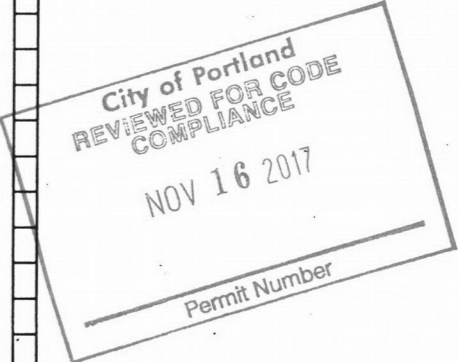

VERTICAL SHAFT ABOVE PER

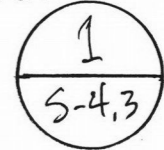

RECEIVED
AUG 08 2017
BDS
DOCUMENT SERVICES

MAIN LEVEL FLOOR PLAN (FIRE SEPARATION)
3/16" = 1'-0"

**CONTRACTOR TO FIELD
VERIFY ALL DIMENSIONS**

SCALES NOTED ON DRAWINGS ARE FOR 11"x17" SHEET. SCALE ACCORDINGLY FOR DIFFERENT SIZE SHEET.

1419 Washington St.
Suite 100
Oregon City, Oregon 97045
Work: 503-657-9800
Cell: 503-449-3080
Andy@jasenginc.com



GABRIEL PARK APART. FIRE RESTORATION
HARBRO
7740 SW 45TH AVE,
PORTLAND, OR 97219

COPYRIGHT 2017 JAS ENGINEERING	DESIGN BY: JAS	DRAWN BY: DAS	JAS PROJ. NO.: 17-024	ISSUE DATE: 5/8/2017
-----------------------------------	-------------------	------------------	--------------------------	-------------------------

SHEET TITLE: MAIN LEVEL FLOOR PLAN
SHEET NO.: A-2.1b

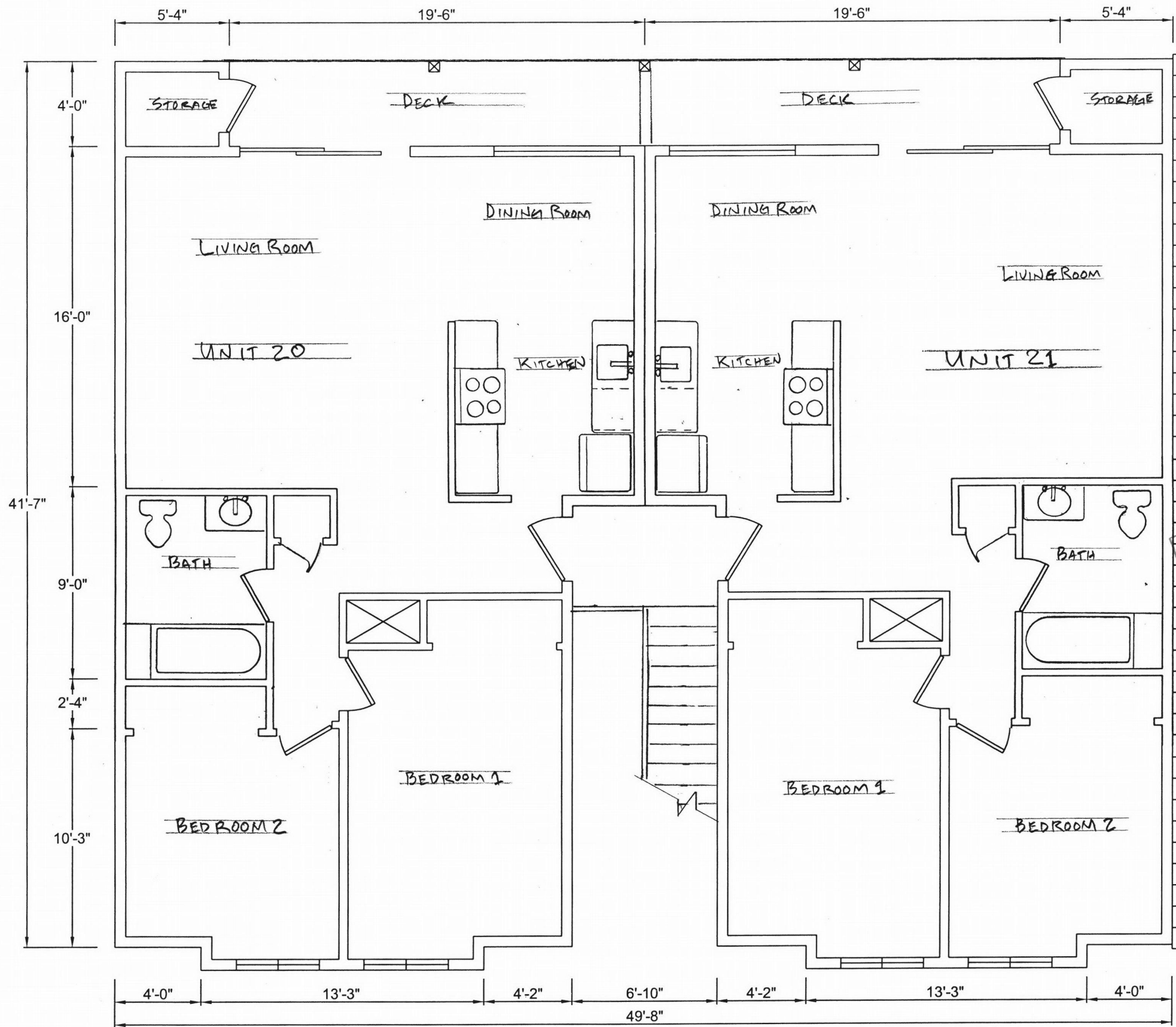

EXPIRE 6-30-2018
 6-8-17

City of Portland
 REVIEWED FOR CODE COMPLIANCE
 NOV 16 2017
 Permit Number

**CONTRACTOR TO FIELD
VERIFY ALL DIMENSIONS**

UPPER LEVEL FLOOR PLAN
 $\frac{3}{16}'' = 1'-0''$

SCALES NOTED ON DRAWINGS ARE FOR 11"x17" SHEET. SCALE ACCORDINGLY FOR DIFFERENT SIZE SHEET.

1419 Washington St,
 Suite 100
 Oregon City, Oregon 97045
 Work: 503-657-9800
 Cell: 503-449-3080
 Andy@jasenginc.com



GABRIEL PARK APART. FIRE RESTORATION
 HARBRO
 7740 SW 45TH AVE,
 PORTLAND, OR 97219

COPYRIGHT 2017 JAS ENGINEERING	DESIGN BY:	JAS
	DRAWN BY:	DAS
JAS PROJ. NO.:	17-024	
ISSUE DATE:	5/8/2017	

SHEET TITLE:	UPPER LEVEL FLOOR PLAN
SHEET NO.:	A-2.2a

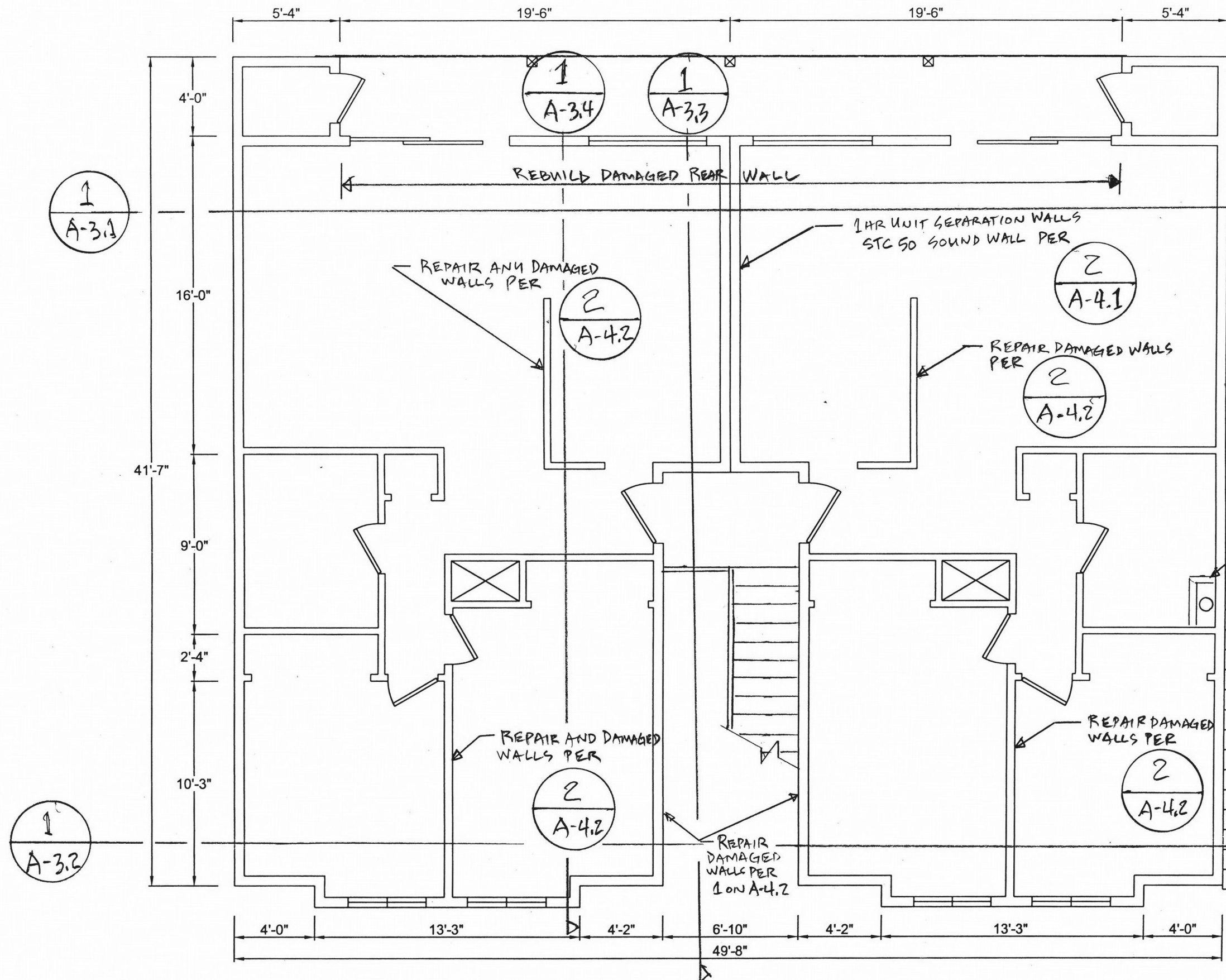

SCRAPE & SEAL AND
SMOKED DAMAGED
FRAMING THAT WILL
REMAIN

City of Portland
REVIEWED FOR CODE
COMPLIANCE
NOV 16 2017
Permit Number

VERTICAL SHAFT
PER
1
S-4.3
EXTEND TO ROOF
SHEATHING ABOVE



EXPIRES: 6-30-2018
6-8-17

UPPER LEVEL FLOOR PLAN (FIRE SEPARATION)
3/16" = 1'-0"

CONTRACTOR TO FIELD
VERIFY ALL DIMENSIONS

SCALES NOTED ON DRAWINGS ARE FOR
11"X17" SHEET. SCALE ACCORDINGLY
FOR DIFFERENT SIZE SHEET.

1419 Washington St.
Suite 100
Oregon City, Oregon 97045
Work: 503-657-9800
Cell: 503-449-3080
Andy@jasenginc.com



GABRIEL PARK APART. FIRE RESTORATION
HARBRO
7740 SW 45TH AVE,
PORTLAND, OR 97219

COPYRIGHT 2017 JAS ENGINEERING	JAS	DAS	17-024	5/8/2017
DESIGN BY:	JAS	DAS		
DRAWN BY:				
JAS PROJ. NO.:				
ISSUE DATE:				

SHEET TITLE:
**UPPER
LEVEL
FLOOR
PLAN**

SHEET NO.
A-2.2b

STRUCTURAL ENGINEER
 REGISTERED PROFESSIONAL ENGINEER
 188500E
 JOHN ANDREW STENINGER
 OREGON
 NOVEMBER 12, 1985
 EXPIRES 6-30-2018
 6-8-17

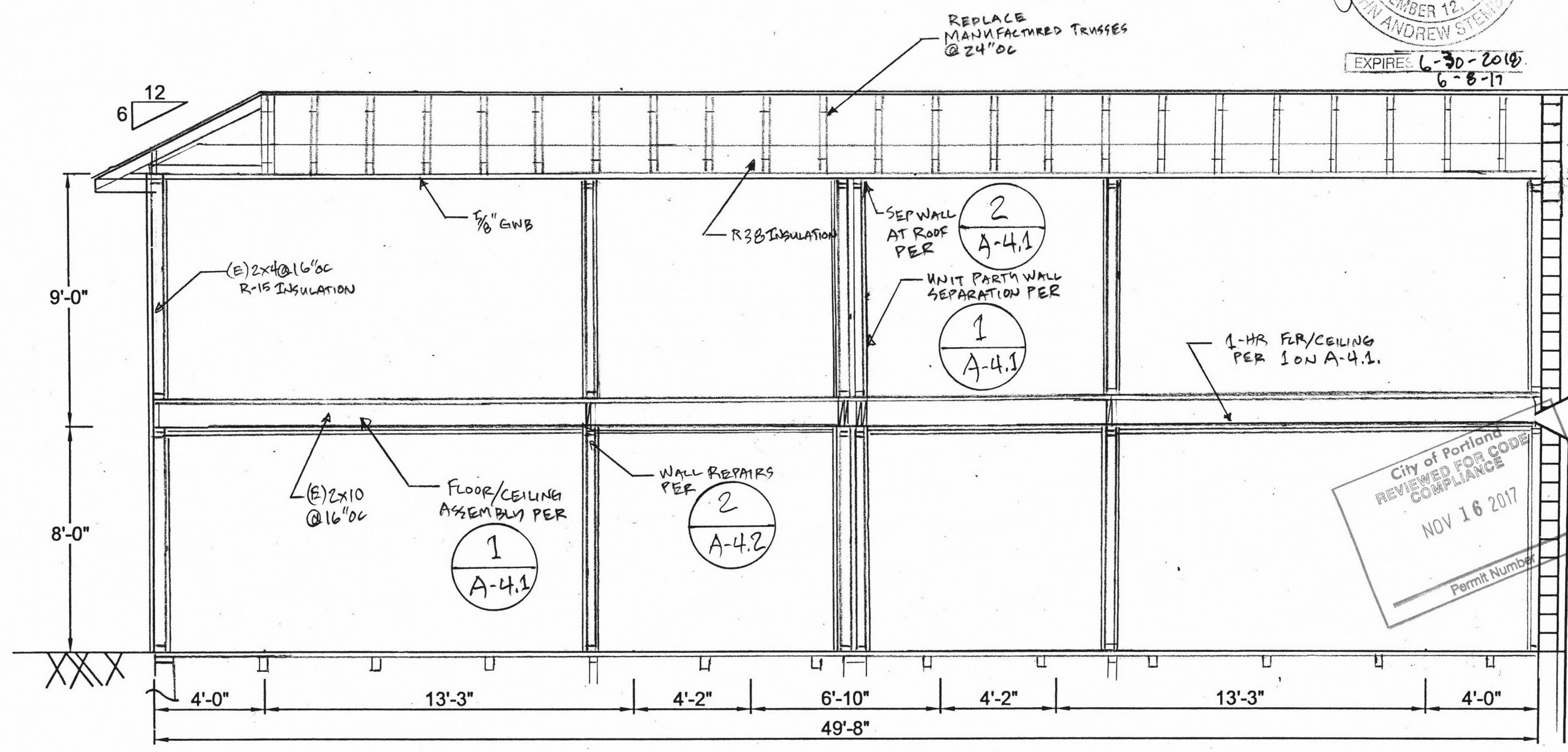

PROVIDE ENERGY ENVELOPE PER NOTE 3 ON A-1.4

1 BUILDING CROSS SECTION
 A-3.1 1/4" = 1'0"

SCALES NOTED ON DRAWINGS ARE FOR 11"x17" SHEET. SCALE ACCORDINGLY FOR DIFFERENT SIZE SHEET.

1419 Washington St.
 Suite 100
 Oregon City, Oregon 97045
 Work: 503-657-9800
 Cell: 503-449-3080
 Andy@jasenginc.com

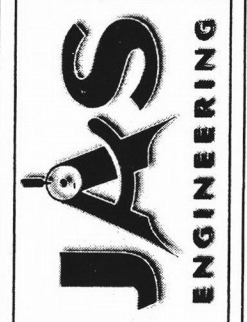

GABRIEL PARK APART. FIRE RESTORATION
 HARBRO
 7740 SW 45TH AVE,
 PORTLAND, OR 97219

COPYRIGHT 2017 JAS ENGINEERING	DESIGN BY: JAS	DRAWN BY: DAS	JAS PROJ. NO: 17-024	ISSUE DATE: 5/6/2017
-----------------------------------	----------------	---------------	----------------------	----------------------

SHEET TITLE:
 BUILDING CROSS SECTION

SHEET NO:
 A-3.1



EXPIRE 6-30-2018
6-8-17

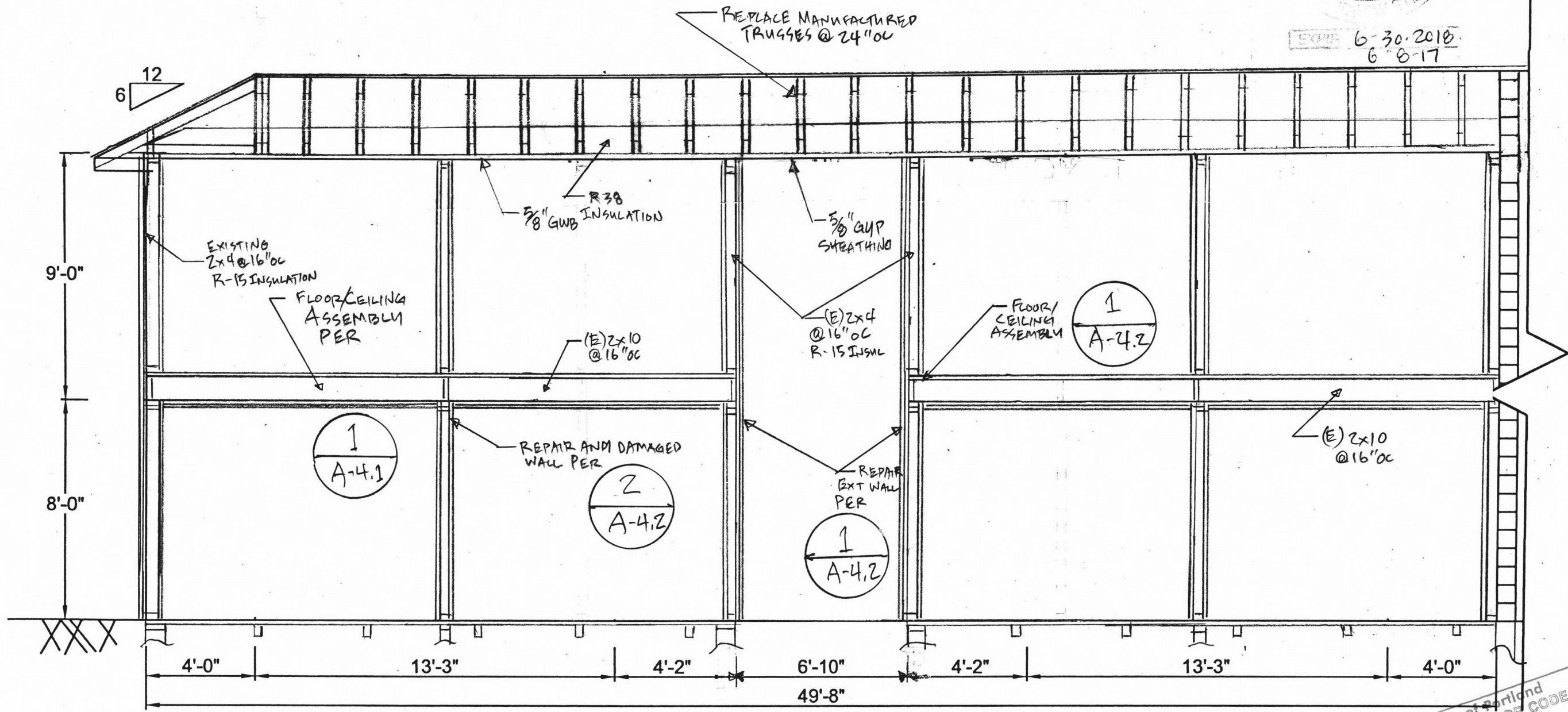

1419 Washington St.
Suite 100
Oregon City, Oregon 97045
Work: 503-657-9800
Cell: 503-449-3080
Andy@jasenginc.com

GABRIEL PARK APART. FIRE RESTORATION
HARBRO
7740 SW 45TH AVE,
PORTLAND, OR 97219

COPYRIGHT 2017 JAS ENGINEERING	DESIGN BY: JAS	DRAWN BY: DAS	JAS PROJ. NO: 17-024	ISSUE DATE: 5/8/2017
-----------------------------------	----------------	---------------	----------------------	----------------------

City of Portland
REVIEWED FOR CODE COMPLIANCE
NOV 16 2017
Permit Number

1 BUILDING CROSS SECTION
A-3.2
1/4" = 1'0"

SCALES NOTED ON DRAWINGS ARE FOR 11"x17" SHEET. SCALE ACCORDINGLY FOR DIFFERENT SIZE SHEET.

SHEET TITLE: BUILDING CROSS SECTION
SHEET NO: A-3.2

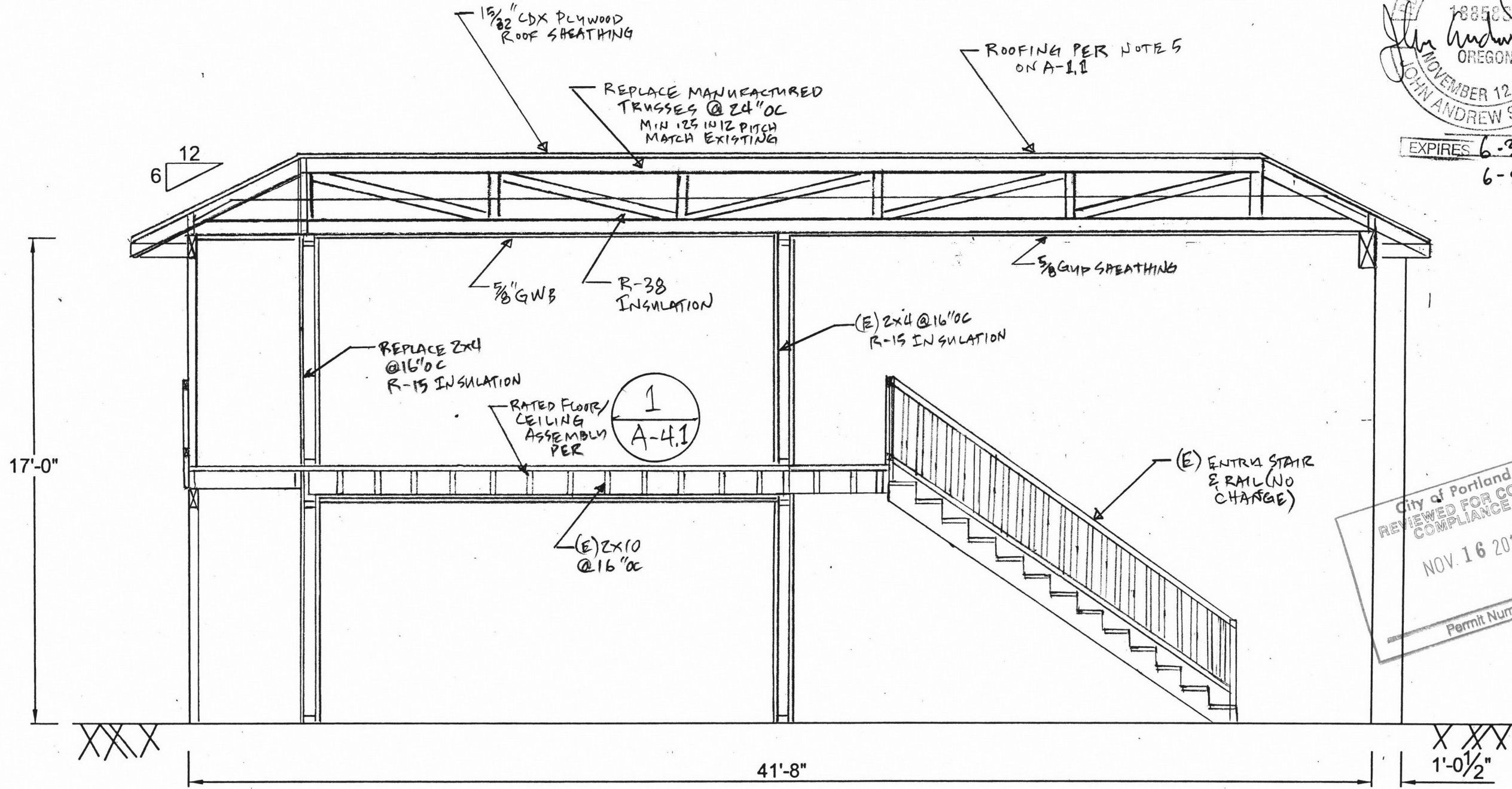

REGISTERED PROFESSIONAL ENGINEER
 JOHN ANDREW STEMBER
 OREGON
 NOVEMBER 12, 1988
 EXPIRES 6-30-2018
 6-8-17

City of Portland
 REVIEWED FOR CODE COMPLIANCE
 NOV. 16 2017
 Permit Number

1 BUILDING CROSS SECTION
 A-3.3 1/4" = 1'0"

1419 Washington St.
 Suite 100
 Oregon City, Oregon 97045
 Work: 503-657-9800
 Cell: 503-449-3080
 Andy@jasenginc.com

JAS
ENGINEERING

GABRIEL PARK APART. FIRE RESTORATION
 HARBRO
 7740 SW 45TH AVE,
 PORTLAND, OR 97219

COPYRIGHT 2017 JAS ENGINEERING		DESIGN BY: JAS	DRAWN BY: DAS	JAS PROJ. NO.: 17-024	ISSUE DATE: 5/8/2017
-----------------------------------	--	-------------------	------------------	--------------------------	-------------------------

SHEET TITLE: BUILDING CROSS SECTION	
SHEET NO.: A-3.3	

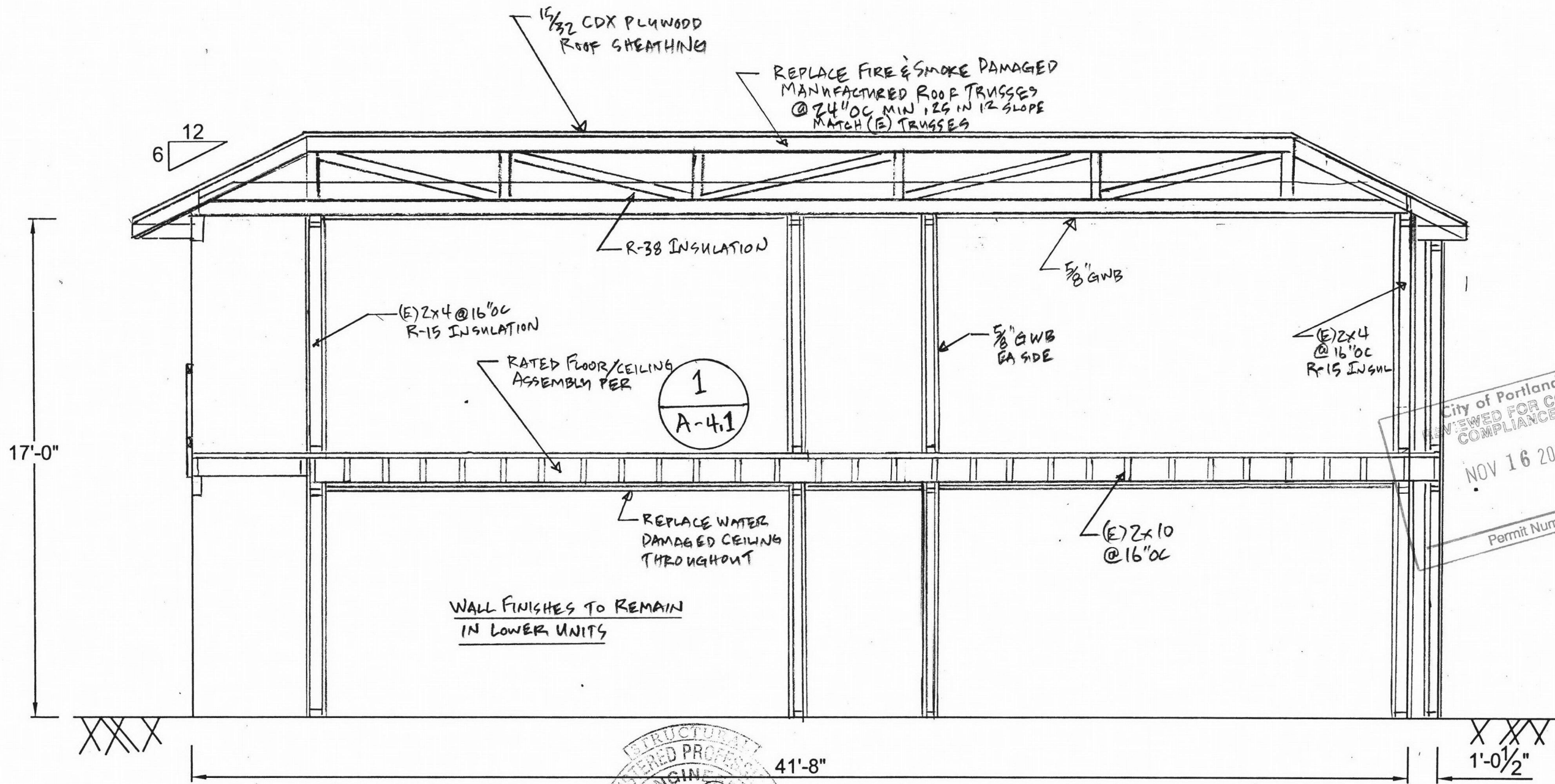

1/2 CDX PLYWOOD
ROOF SHEATHING

REPLACE FIRE & SMOKE DAMAGED
MANUFACTURED ROOF TRUSSES
@ 24" OC MIN, 25 IN 12 SLOPE
MATCH (E) TRUSSES

R-38 INSULATION

(E)2x4 @ 16" OC
R-15 INSULATION

RATED FLOOR/CEILING
ASSEMBLY PER

1
A-4.1

5/8" GWB

5/8" GWB
EA SIDE

(E)2x4
@ 16" OC
R-15 INSUL

REPLACE WATER
DAMAGED CEILING
THROUGHOUT

WALL FINISHES TO REMAIN
IN LOWER UNITS

(E)2x10
@ 16" OC

City of Portland
REVIEWED FOR CODE
COMPLIANCE
NOV 16 2017
Permit Number

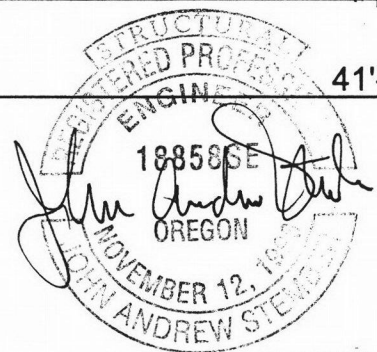

EXPIRES 6-30-2018
6-8-17

1
A-3.4 BUILDING CROSS SECTION
1/4" = 1'0"

1419 Washington St.
Suite 100
Oregon City, Oregon 97045
Work: 503-657-9800
Cell: 503-449-3080
Andy@jasenginc.com

GABRIEL PARK APART. FIRE RESTORATION
HARBRO
7740 SW 45TH AVE,
PORTLAND, OR 97219

COPYRIGHT 2017 JAS ENGINEERING	DESIGN BY: JAS	DRAWN BY: DAS	JAS PROJ. NO: 17-024	ISSUE DATE: 5/8/2017
-----------------------------------	-------------------	------------------	-------------------------	-------------------------

SHEET TITLE: BUILDING CROSS SECTION
SHEET NO: A-3.4

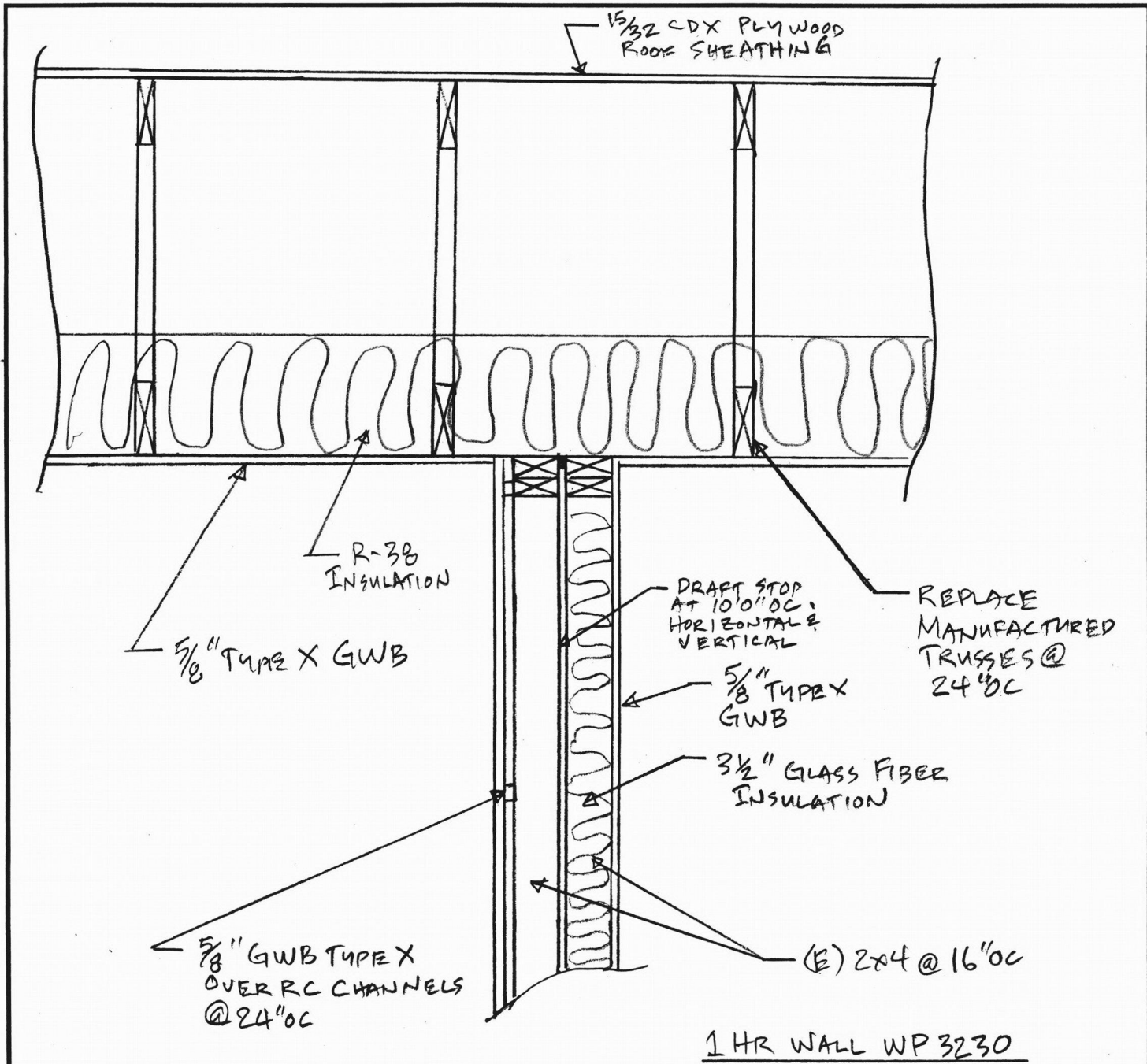

2
A-4.1
1-HR RATED PARTY WALL
1" = 1'0" STC 50

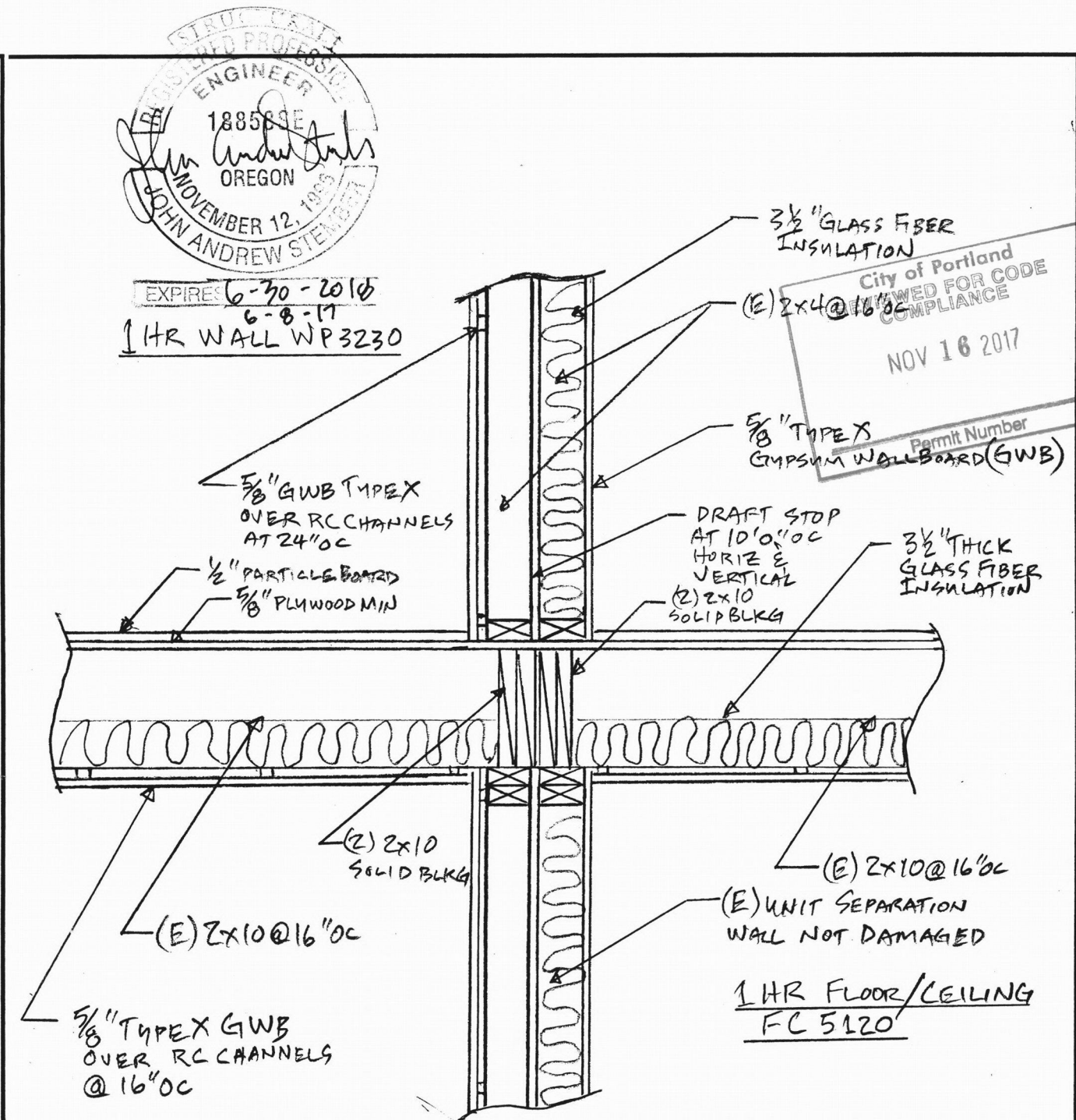

1
A-4.1
1-HR RATED PARTY WALL & FLOOR CEILING
1" = 1'0" STC 50

SCALES NOTED ON DRAWINGS ARE FOR 11"X17" SHEET. SCALE ACCORDINGLY FOR DIFFERENT SIZE SHEET.

1419 Washington St.
Suite 100
Oregon City, Oregon 97045
Work: 503-657-9800
Cell: 503-449-3080
Andy@jasenginc.com



GABRIEL PARK APART. FIRE RESTORATION
HARBRO
7740 SW 45TH AVE,
PORTLAND, OR 97219

COPYRIGHT 2017 JAS ENGINEERING	DESIGN BY: JAS	DRAWN BY: DAS	JAS PROJ. NO: 17-024	ISSUE DATE: 5/8/2017
-----------------------------------	----------------	---------------	----------------------	----------------------

SHEET TITLE:
FIRE SEPARATION
DETAILS

SHEET NO:
A-4.1

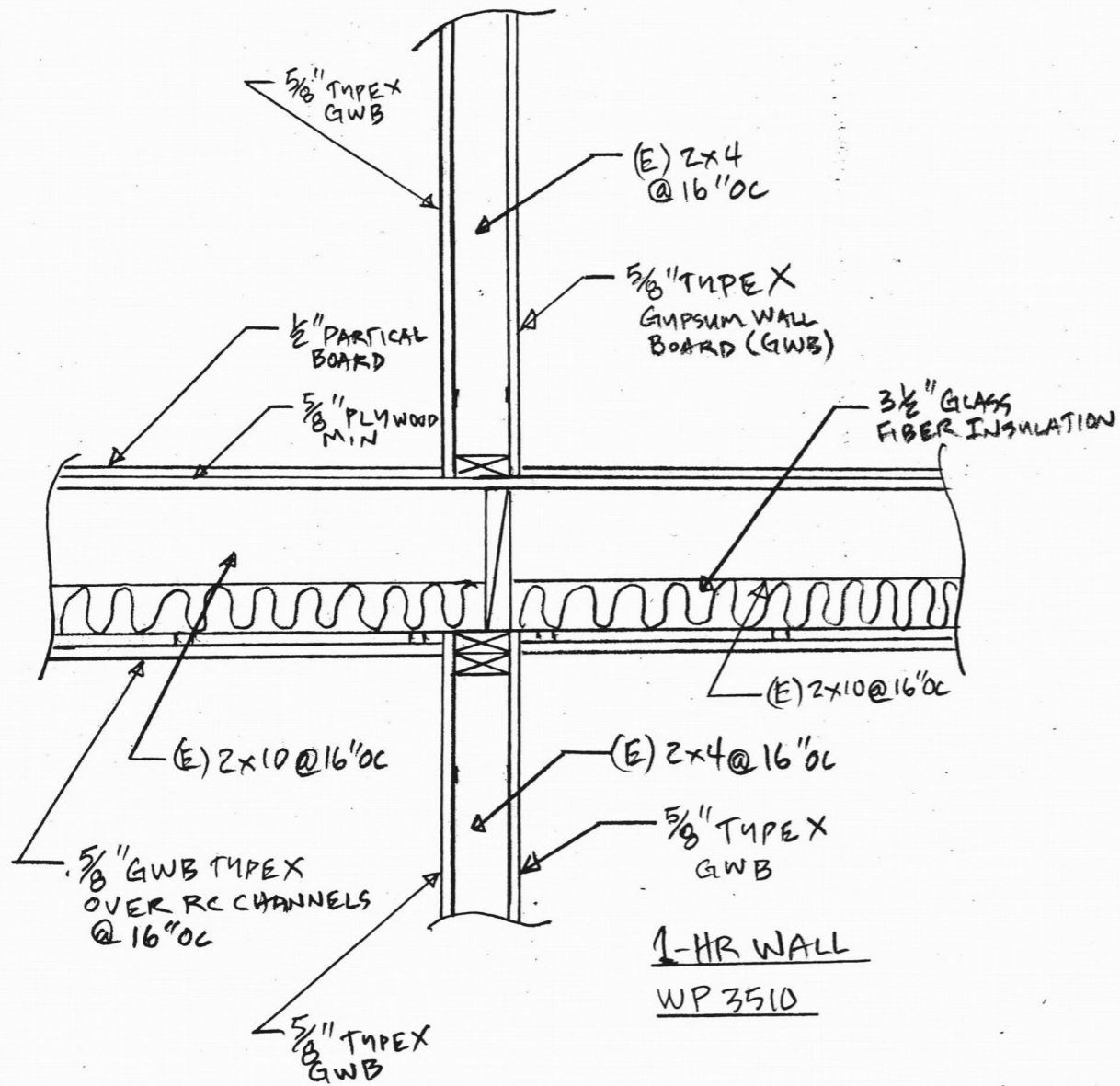

2 1-HR INTERIOR RATED WALL AT 1HR FLOOR/CEILING
 A-4.2 1" = 1'0"

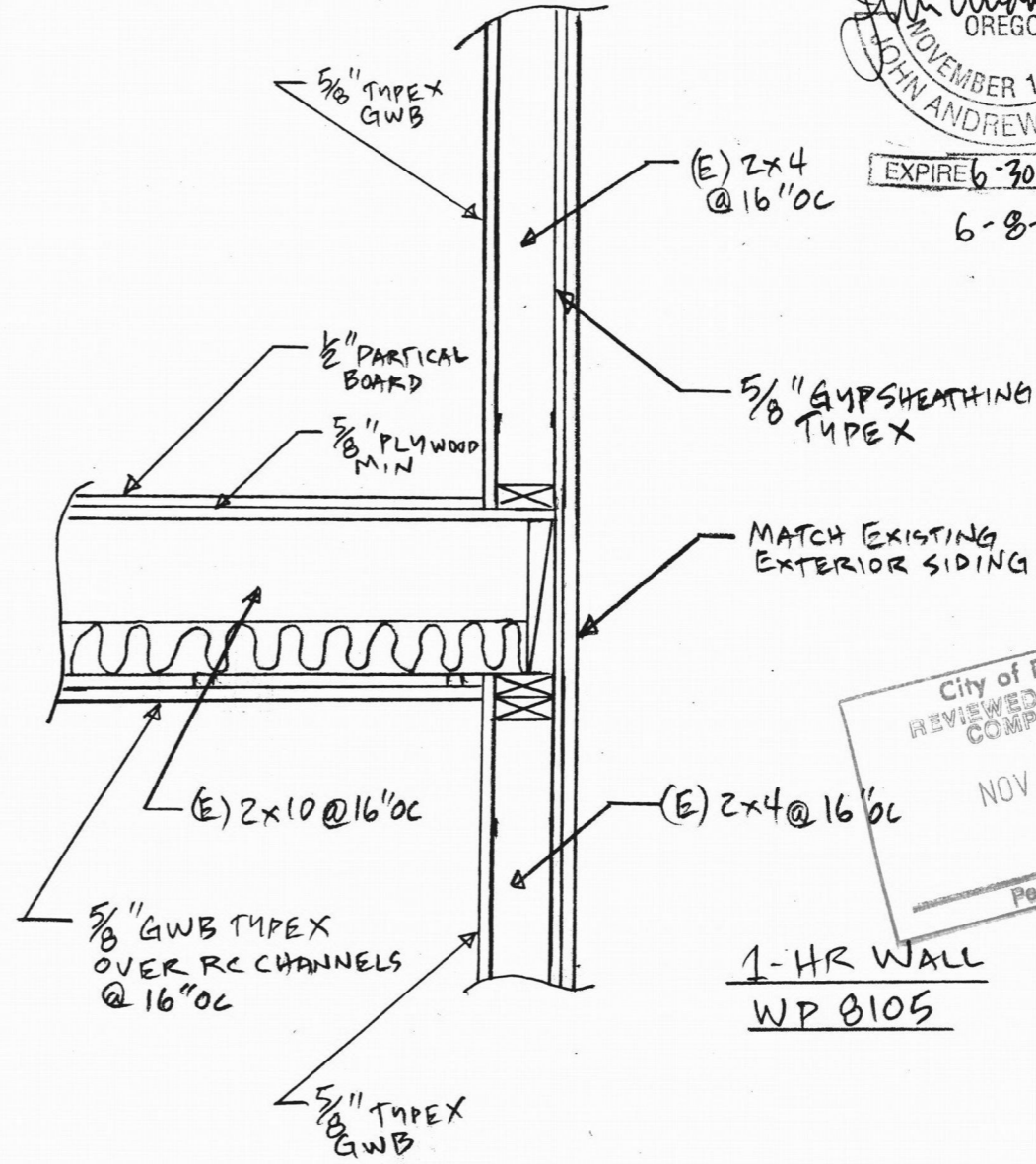

1 1-HR EXTERIOR RATED WALL AT 1HR FLOOR/CEILING
 A-4.2 1" = 1'0"



EXPIRE 6-30-2018
 6-8-17

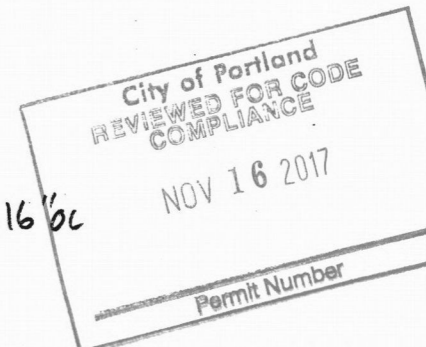

1-HR WALL
 WP 8105

1419 Washington St.
 Suite 100
 Oregon City, Oregon 97045
 Work: 503-657-9800
 Cell: 503-449-3080
 Andy@jasenginc.com



GABRIEL PARK APART. FIRE RESTORATION
 HARBRO
 7740 SW 45TH AVE,
 PORTLAND, OR 97219

COPYRIGHT 2017 JAS ENGINEERING		JAS	17-024
DESIGN BY:	JAS	DAS	5/8/2017
DRAWN BY:	JAS		
JAS PROJ. NO.:			
ISSUE DATE:			

SHEET TITLE:
 FIRE RATED
 WALL DETAILS

SHEET NO.:
 A-4.2

SCALES NOTED ON DRAWINGS ARE FOR 11"x17" SHEET. SCALE ACCORDINGLY FOR DIFFERENT SIZE SHEET.

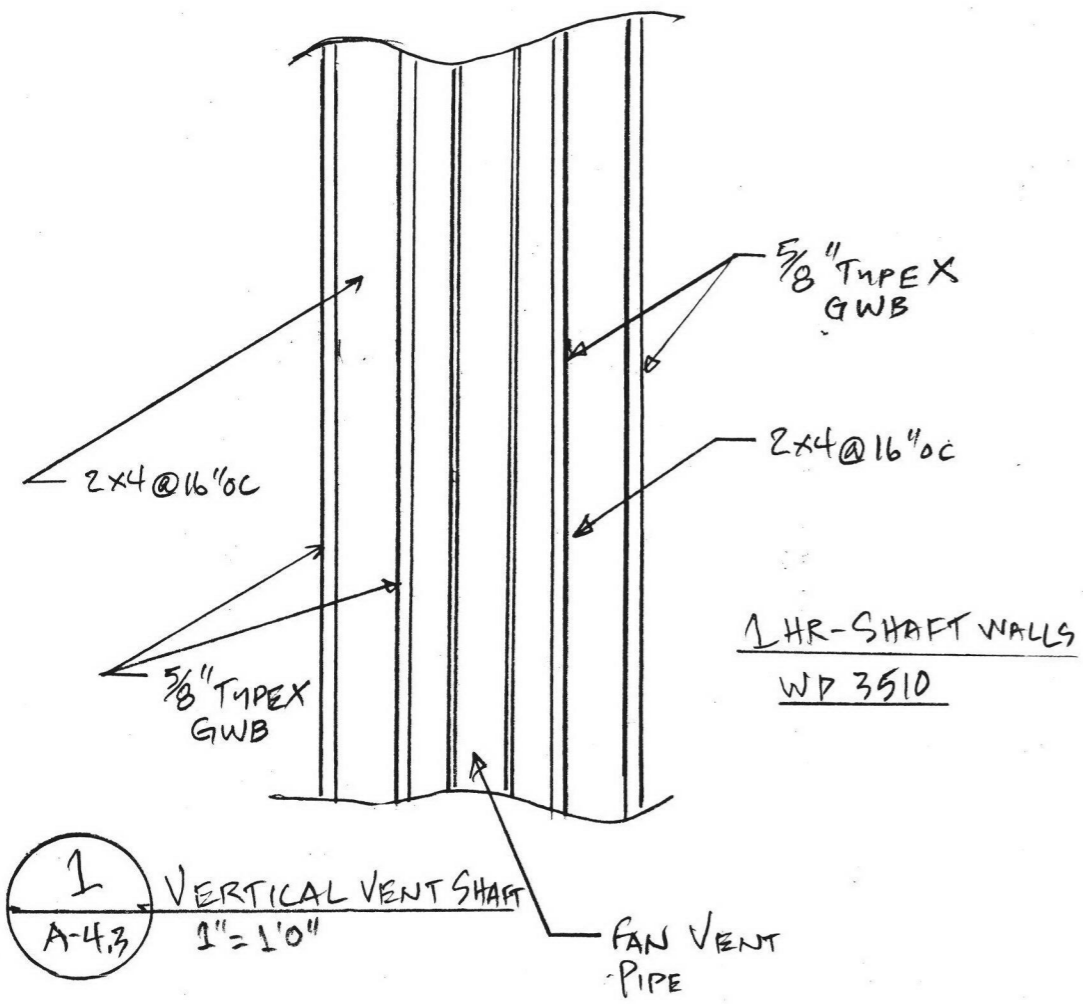

1
A-4.3
VERTICAL VENT SHAFT
1" = 1'0"
FAN VENT PIPE

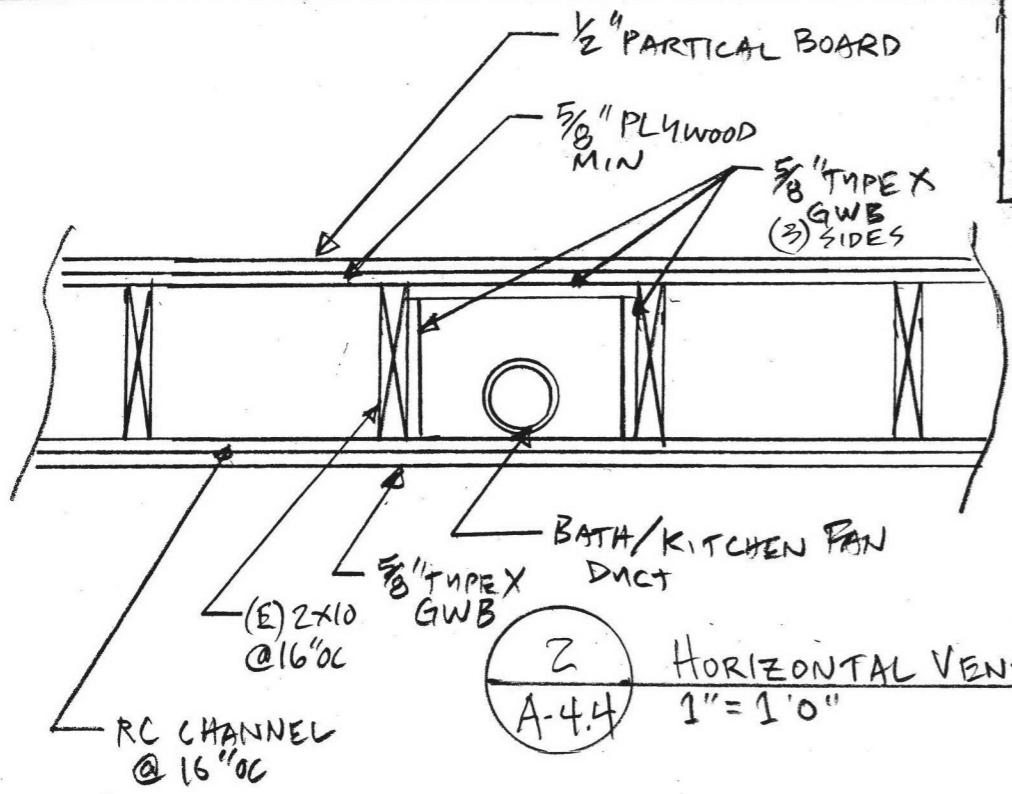

2
A-4.4
HORIZONTAL VENT SHAFT
1" = 1'0"
BATH/KITCHEN FAN DUCT

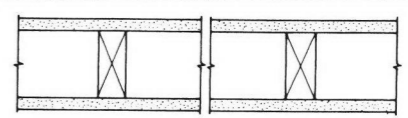
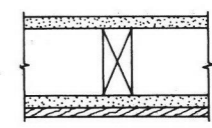
Fire Rating	Sound Rating STC	GA File No.	ASSEMBLY DESCRIPTION	SKETCH AND DESIGN DATA	
				Fire	Sound
1 HR	35 to 39	WP 3510	Gypsum Wallboard, Wood Studs One layer 5/8" type X gypsum wallboard or veneer base applied parallel with or at right angles to each side of 2 x 4 wood studs spaced 24" o.c. with 6d coated nails 1 7/8" long, 0.0915" shank, 1/4" heads, 7" o.c. Wallboard nailed to top and bottom plates at 7" o.c. Stagger joints 24" o.c. each side. (LOAD-BEARING)	 Thickness: 4 7/8" Approx. Weight: 7 psf Fire Test: UL R3501-47, 48, 9-17-65; Design U309 R1319-129, 7-22-70 Design U314 Sound Test: NGC 2404, 10-14-70	
EXTERIOR WALLS					
1 HR		WP 8105	Gypsum Wallboard, Gypsum Sheathing, Wood Studs Interior side: One layer 5/8" type X gypsum wallboard or water resistant backer board or veneer base applied parallel with or at right angles to 2 x 4 wood studs, 24" o.c. with 6d coated nails 1 7/8" long, 0.0915" shank, 1/4" heads, 7" o.c. Joints of square edge or bevel edge wallboard may be left exposed. Exterior side: One layer 5/8" type X gypsum sheathing, 48" wide, applied parallel to studs with galv roofing nails, 1 3/4" long, 0.120" shank, 7/16" or 1/2" heads, 7" o.c. in field, 4" o.c. perimeter. Wallboard and sheathing nailed to top and bottom plates at 7" o.c. Exterior cladding to be attached through sheathing to studs. (LOAD-BEARING)	 Thickness: 4 3/4" Approx. Weight: 7 psf Fire Test: See WP 3510 Insulation: See page 6, Section 10.1.	



SCALES NOTED ON DRAWINGS ARE FOR 11"x17" SHEET. SCALE ACCORDINGLY FOR DIFFERENT SIZE SHEET.

1419 Washington St.
Suite 100
Oregon City, Oregon 97045
Work: 503-657-9800
Cell: 503-449-3080
Andy@jasenginc.com



GABRIEL PARK APART. FIRE RESTORATION
HARBRO
7740 SW 45TH AVE,
PORTLAND, OR 97219

COPYRIGHT 2017 JAS ENGINEERING	JAS	DAS	17-024	5/8/2017
DESIGN BY:	JAS	DAS		
DRAWN BY:				
JAS PROJ. NO.:				
ISSUE DATE:				

SHEET TITLE: FIRE RATED SHAFT DETAILS
SHEET NO.: A-4.3

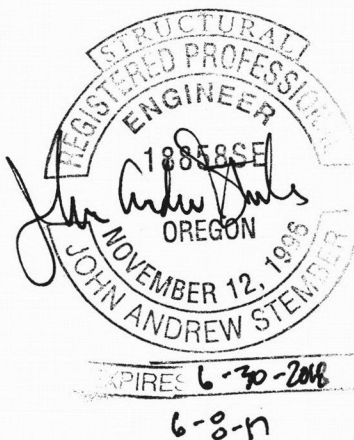

**SECTION 708
FIRE PARTITIONS**

708.1 General. The following wall assemblies shall comply with this section.

- 1. Walls separating *dwelling units* in the same building as required by Section 420.2.
- 2. Walls separating *sleeping units* in the same building as required by Section 420.2.
- 3. Walls separating tenant spaces in *covered and open mall buildings* as required by Section 402.4.2.1.
- 4. Corridor walls as required by Section 1018.1.
- 5. Elevator lobby separation as required by Section 713.14.1.

708.2 Materials. The walls shall be of materials permitted by the building type of construction.

→ **708.3 Fire-resistance rating.** Fire partitions shall have a fire-resistance rating of not less than 1 hour.

→ **708.4 Continuity.** Fire partitions shall extend from the top of the foundation or floor/ceiling assembly below to the underside of the floor or roof sheathing, slab or deck above or to the fire-resistance-rated floor/ceiling or roof/ceiling assembly above, and shall be securely attached thereto. In combustible construction where the *fire partitions* are not required to be continuous to the sheathing, deck or slab, the space between the ceiling and the sheathing, deck or slab above shall be fire-blocked or draftstopped in accordance with Sections 718.2 and 718.3 at the partition line. The supporting construction shall be protected to afford the required fire-resistance rating of the wall supported, except for walls separating tenant spaces in *covered and open mall buildings*, walls separating *dwelling units*, walls separating *sleeping units* and *corridor walls*, in buildings of Type IIB, IIIB and VB construction.

Exceptions:

- 5. Attic fireblocking or draftstopping is not required at the partition line in Group R-2 buildings that do not exceed four stories above grade plane, provided the attic space is subdivided by draftstopping into areas not exceeding 3,000 square feet (279 m²) or above every two *dwelling units*, whichever is smaller.

**SECTION 711
HORIZONTAL ASSEMBLIES**

711.1 General. Floor and roof assemblies required to have a fire-resistance rating shall comply with this section. Nonfire-resistance-rated floor and roof assemblies shall comply with Section 714.4.2.

711.2 Materials. The floor and roof assemblies shall be of materials permitted by the building type of construction.

FLOOR-CEILING ASSEMBLIES, WOOD-FRAMED

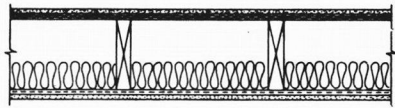
Fire Rating	Sound Rating STC	GA File No.	ASSEMBLY DESCRIPTION	SKETCH AND DESIGN DATA	
				Fire	Sound
1 HR	50 to 54	FC 5120	Wood Joists, Gypsum Wallboard, Glass Fiber 1/2" type X gypsum wallboard or veneer base applied at right angles to resilient furring channels with 1" Type S drywall screws 8" o.c. on ends and 12" o.c. in field. Wallboard end joints located midway between continuous channels and attached to additional pieces of channel 54" long with screws 8" o.c. Resilient furring channels applied 24" o.c. at right angles to 2 x 10 wood joists 16" o.c. with 6d coated nails 1 7/8" long, 0.085" shank, 1/4" heads, two per joist. Wood joists supporting 5/8" interior plywood with exterior glue subfloor and 3/8" particle board 1.5 psf. 3 1/2" thick glass fiber insulation batts 0.7 pcf friction fit in joist cavities supported alternately every 12" by wire rods and resilient furring channels. Sound tested with carpet and pad and with insulation stapled to joists.		Approx. Ceiling Weight: 2 psf Fire Test: FM FC-181, 8-31-72 Sound Test: G & H OC-3 MT, 10-13-71 IIC & Test: (73 C & P) G & H OC-3 MT, 10-13-71

WALLS AND INTERIOR PARTITIONS, WOOD-FRAMED

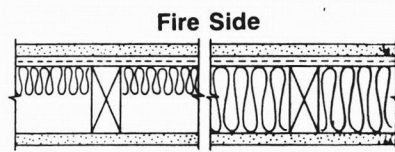
Fire Rating	Sound Rating STC	GA File No.	ASSEMBLY DESCRIPTION	SKETCH AND DESIGN DATA	
				Fire	Sound
1 HR	50 to 54	WP 3230	Gypsum Wallboard, Glass Fiber, Wood Studs One layer 5/8" type X gypsum wallboard or veneer base applied parallel to resilient channels 24" o.c. with 1" Type S drywall screws at edges 6" o.c. and center row 12" o.c. End joints back-blocked with resilient channels. Resilient channels attached at right angles to 2 x 4 wood studs 16" o.c. with 6d coated nails, 1 7/8" long, 0.086" shank, 1/4" heads, 1/2" x 3" gypsum wallboard filler strip attached to plate at floor line with 6d nails as described above 16" o.c. 1 1/2" glass fiber 0.8 pcf attached to studs in stud space with 1/2" long staples. On opposite side one layer 5/8" type X gypsum wallboard or veneer base applied at right angles to studs with 6d nails as described above 8" o.c. Stagger end joints 48" o.c. each side. Sound tested with 3 1/2" glass fiber insulation. (LOAD-BEARING)		Thickness: 5 3/8" Approx. Weight: 7 psf Fire Test: OSU T-3127, 10-4-65 Sound Test: RAL TL 77-138, 5-5-77



711.3 Fire-resistance rating. The fire-resistance rating of floor and roof assemblies shall not be less than that required by the building type of construction. Where the floor assembly separates mixed occupancies, the assembly shall have a fire-resistance rating of not less than that required by Section 508.4 based on the occupancies being separated. Where the floor assembly separates a single occupancy into different fire areas, the assembly shall have a fire-resistance rating of not less than that required by Section 707.3.10. Horizontal assemblies separating dwelling units in the same building and horizontal assemblies separating sleeping units in the same building shall be a minimum of 1-hour fire-resistance-rated construction.

711.4 Continuity. Assemblies shall be continuous without openings, penetrations or joints except as permitted by this section and Sections 712.1, 714.4, 715, 1009.3 and 1022.1. Skylights and other penetrations through a fire-resistance-rated roof deck or slab are permitted to be unprotected, provided that the structural integrity of the fire-resistance-rated roof assembly is maintained. Unprotected skylights shall not be permitted in roof assemblies required to be fire-resistance rated in accordance with Section 705.8.6. The supporting construction shall be protected to afford the required fire-resistance rating of the horizontal assembly supported.

SCALES NOTED ON DRAWINGS ARE FOR 11"X17" SHEET. SCALE ACCORDINGLY FOR DIFFERENT SIZE SHEET.

1419 Washington St.
Suite 100
Oregon City, Oregon 97045
Work: 503-657-9800
Cell: 503-449-3080
Andy@jasenginc.com



GABRIEL PARK APART. FIRE RESTORATION
HARBRO
7740 SW 45TH AVE,
PORTLAND, OR 97219

COPYRIGHT 2017 JAS ENGINEERING	DESIGN BY: JAS	DRAWN BY: DAS	JAS PROJ. NO.: 17-024	ISSUE DATE: 5/20/17
-----------------------------------	-------------------	------------------	--------------------------	------------------------

SHEET TITLE:
FIRE RATED ASSEMBLIES

SHEET NO.:
A-4.4

"Normal" Construction . . .
Arrows show flanking paths

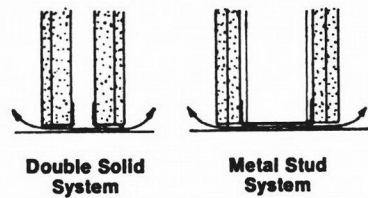

Elevation
Under and Over Partitions

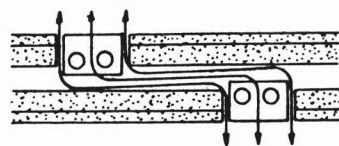

Plan
Through partitions-openings,
outlet boxes

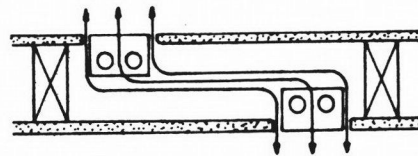

Plan
Through partitions-openings,
outlet boxes

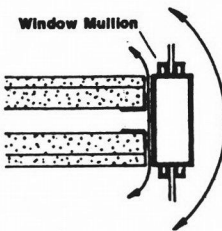

Plan
Double Solid
Around-flanking partition ends

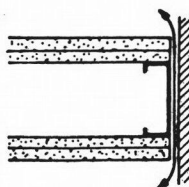

Plan
Metal Stud
Around-flanking partition ends

"Select" Construction . . .
Sealing of relief detail at perimeter
of partition and around cut-outs to
prevent sound leakage

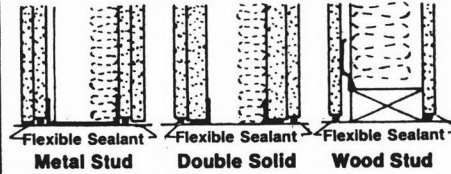

Elevation

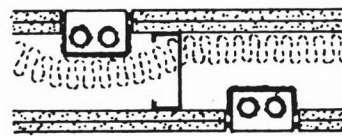

Plan
Indicating sealing of openings
through partitions

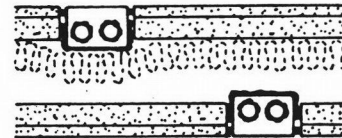

Plan
Indicating sealing of openings
through partitions

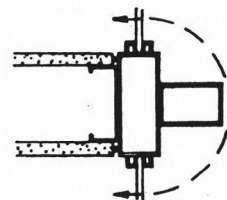

Plan
Typical partition-mullion intersection

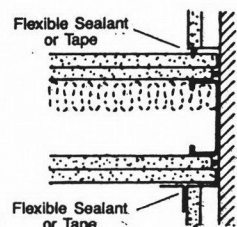

Plan
Intersection with interior wall

"Pre-design" Construction . . .
Simulating laboratory conditions

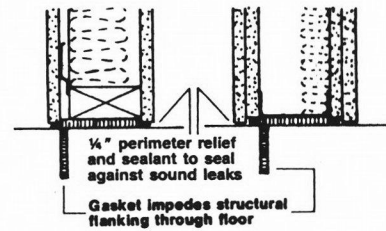

Elevation
Typical Floor-Ceiling or Roof Detail

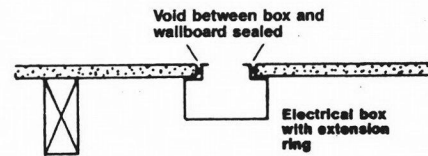

Plan
Outlet Box Detail

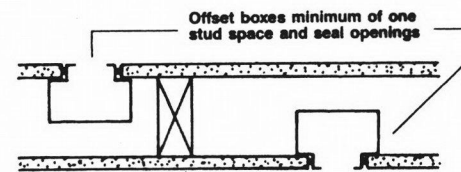

Plan
Outlet Box Details

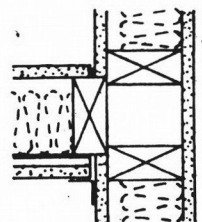

Plan
Intersection with exterior wall

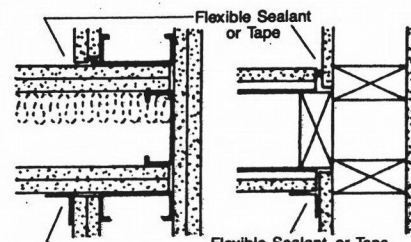

Plan
Typical partition intersections

SECTION 714
PENETRATIONS

714.1 Scope. The provisions of this section shall govern the materials and methods of construction used to protect through penetrations and membrane penetrations of horizontal assemblies and fire-resistance-rated wall assemblies.

714.3 Fire-resistance-rated walls. Penetrations into or through fire walls, fire barriers, smoke barrier walls and fire partitions shall comply with Sections 714.3.1 through 714.3.3. Penetrations in smoke barrier walls shall also comply with Section 714.5.

714.3.2 Membrane penetrations. Membrane penetrations shall comply with Section 714.3.1. Where walls or partitions are required to have a fire-resistance rating, recessed fixtures shall be installed such that the required fire-resistance will not be reduced.

Exceptions:

1. Membrane penetrations of maximum 2-hour fire-resistance-rated walls and partitions by steel electrical boxes that do not exceed 16 square inches (0.0103 m²) in area, provided the aggregate area of the openings through the membrane does not exceed 100 square inches (0.0645 m²) in any 100 square feet (9.29 m²) of wall area. The annular space between the wall membrane and the box shall not exceed 1/8 inch (3.1 mm). Such boxes on opposite sides of the wall or partition shall be separated by one of the following:
 - 1.1. By a horizontal distance of not less than 24 inches (610 mm) where the wall or partition is constructed with individual noncommunicating stud cavities;

2014 OREGON STRUCTURAL SPECIALTY CODE

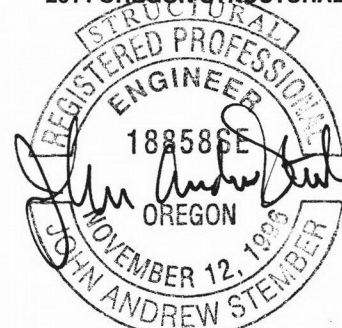

EXPIRES: 6-30-2018
6-8-17

RATED WALL PENETRATIONS

- 1.2. By a horizontal distance of not less than the depth of the wall cavity where the wall cavity is filled with cellulose loose-fill, rockwool or slag mineral wool insulation;
 - 1.3. By solid fireblocking in accordance with Section 718.2.1;
 - 1.4. By protecting both outlet boxes with listed putty pads; or
 - 1.5. By other listed materials and methods.
2. Membrane penetrations by listed electrical boxes of any material, provided such boxes have been tested for use in fire-resistance-rated assemblies and are installed in accordance with the instructions included in the listing. The annular space between the wall membrane and the box shall not exceed 1/8 inch (3.1 mm) unless listed otherwise. Such boxes on opposite sides of the wall or partition shall be separated by one of the following:
 - 2.1. By the horizontal distance specified in the listing of the electrical boxes;
 - 2.2. By solid fireblocking in accordance with Section 718.2.1;
 - 2.3. By protecting both boxes with listed putty pads; or
 - 2.4. By other listed materials and methods.
 3. Membrane penetrations by electrical boxes of any size or type, which have been listed as part of a wall opening protective material system for use in fire-resistance-rated assemblies and are installed in accordance with the instructions included in the listing.
 4. Membrane penetrations by boxes other than electrical boxes, provided such penetrating items and the annular space between the wall membrane and the box, are protected by an approved membrane penetration firestop system installed as tested in accordance with ASTM E 814 or UL 1479, with a minimum positive pressure differential of 0.01 inch (2.49 Pa) of water, and shall have an F and T rating of not less than the required fire-resistance rating of the wall penetrated and be installed in accordance with their listing.
 5. The annular space created by the penetration of an automatic sprinkler, provided it is covered by a metal escutcheon plate.

SCALES NOTED ON DRAWINGS ARE FOR 11"X17" SHEET. SCALE ACCORDINGLY FOR DIFFERENT SIZE SHEET.

1419 Washington St,
Suite 100
Oregon City, Oregon 97045
Work: 503-657-9800
Cell: 503-449-3080
Andy@jasenginc.com



GABRIEL PARK APART. FIRE RESTORATION
HARBRO
7740 SW 45TH AVE,
PORTLAND, OR 97219

COPYRIGHT 2017 JAS ENGINEERING	DESIGN BY: JAS	DRAWN BY: DAS	JAS PROJ. NO: 17-024	ISSUE DATE: 5/8/2017
-----------------------------------	----------------	---------------	----------------------	----------------------

SHEET TITLE:
RATED WALL PENETRATIONS

SHEET NO:
A-4.5

NOV 16 2017
Permit Number

714.4.1.1 Through penetrations. Through penetrations of fire-resistance-rated *horizontal assemblies* shall comply with Section 714.4.1.1.1 or 714.4.1.1.2.

Exceptions:

1. Penetrations by steel, ferrous or copper conduits, pipes, tubes or vents or concrete or masonry items through a single fire-resistance-rated floor assembly where the *annular space* is protected with materials that prevent the passage of flame and hot gases sufficient to ignite cotton waste when subjected to ASTM E 119 or UL 263 time-temperature fire conditions under a minimum positive pressure differential of 0.01 inch (2.49 Pa) of water at the location of the penetration for the time period equivalent to the *fire-resistance rating* of the construction penetrated. Penetrating items with a maximum 6-inch (152 mm) nominal diameter shall not be limited to the penetration of a single fire-resistance-rated floor assembly, provided the aggregate area of the openings through the assembly does not exceed 144 square inches (92 900 mm²) in any 100 square feet (9.3 m²) of floor area.
2. Penetrations in a single concrete floor by steel, ferrous or copper conduits, pipes, tubes or vents with a maximum 6-inch (152 mm) nominal diameter, provided the concrete, grout or mortar is installed the full thickness of the floor or the thickness required to maintain the *fire-resistance rating*. The penetrating items shall not be limited to the penetration of a single concrete floor, provided the area of the opening through each floor does not exceed 144 square inches (92 900 mm²).
3. Penetrations by *listed* electrical boxes of any material, provided such boxes have been tested for use in fire-resistance-rated assemblies and installed in accordance with the instructions included in the listing.

714.4.1.1.1 Installation. Through penetrations shall be installed as tested in the *approved* fire-resistance-rated assembly.

714.4.1.1.2 Through-penetration firestop system. Through penetrations shall be protected by an *approved through-penetration firestop system* installed and tested in accordance with ASTM E 814 or UL 1479, with a minimum positive pressure dif-

714.3.1 Through penetrations. Through penetrations of fire-resistance-rated walls shall comply with Section 714.3.1.1 or 714.3.1.2.

Exception: Where the penetrating items are steel, ferrous or copper pipes, tubes or conduits, the *annular space* between the penetrating item and the fire-resistance-rated wall is permitted to be protected as follows:

2. The material used to fill the *annular space* shall prevent the passage of flame and hot gases sufficient to ignite cotton waste when subjected to ASTM E 119 or UL 263 time-temperature fire conditions under a minimum positive pressure differential of 0.01 inch (2.49 Pa) of water at the location of the penetration for the time period equivalent to the *fire-resistance rating* of the construction penetrated.

714.4.1.2 Membrane penetrations. Penetrations of membranes that are part of a *horizontal assembly* shall comply with Section 714.4.1.1.1 or 714.4.1.1.2. Where floor/ceiling assemblies are required to have a *fire-resistance rating*, recessed fixtures shall be installed such that the required *fire resistance* will not be reduced.

Exceptions:

1. *Membrane penetrations* by steel, ferrous or copper conduits, pipes, tubes or vents, or concrete or masonry items where the *annular space* is protected either in accordance with Section 714.4.1.1 or to prevent the free passage of flame and the products of combustion. The aggregate area of the openings through the membrane shall not exceed 100 square inches (64 500 mm²) in any 100 square feet (9.3 m²) of ceiling area in assemblies tested without penetrations.
2. Ceiling *membrane penetrations* of maximum 2-hour *horizontal assemblies* by steel electrical boxes that do not exceed 16 square inches (10 323 mm²) in area, provided the aggregate area of such penetrations does not exceed 100 square inches (44 500 mm²) in any 100 square feet (9.29 m²) of ceiling area, and the *annular space* between the ceiling membrane and the box does not exceed 1/8 inch (3.2 mm).
3. *Membrane penetrations* by electrical boxes of any size or type, which have been *listed* as part of an opening protective material system for use in *horizontal assemblies* and are installed in accordance with the instructions included in the listing.
4. *Membrane penetrations* by *listed* electrical boxes of any material, provided such boxes have been tested for use in fire-resistance-rated assemblies and are installed in accordance with the instructions included in the listing. The *annular space* between the ceiling membrane and the box shall not exceed 1/8 inch (3.2 mm) unless *listed* otherwise.
7. The ceiling membrane of 1- and 2-hour fire-resistance-rated horizontal assemblies is permitted to be interrupted with the double wood top plate of a *fire-resistance-rated* wall assembly, provided that all penetrating items through the double top plates are protected in accordance with Section 714.4.1.1.1 or 714.4.1.1.2. The *fire-resistance rating* of the wall shall not be less than the rating of the horizontal assembly.

RATED FLOOR/CEILING PENETRATIONS

714.3.2 Membrane penetrations. Membrane penetrations shall comply with Section 714.3.1. Where walls or partitions are required to have a *fire-resistance rating*, recessed fixtures shall be installed such that the required fire-resistance will not be reduced.

Exceptions:

1. Membrane penetrations of maximum 2-hour fire-resistance-rated walls and partitions by steel electrical boxes that do not exceed 16 square inches (0.0103 m²) in area, provided the aggregate area of the openings through the membrane does not exceed 100 square inches (0.0645 m²) in any 100 square feet (9.29 m²) of wall area. The *annular space* between the wall membrane and the box shall not exceed 1/8 inch (3.1 mm). Such boxes on opposite sides of the wall or partition shall be separated by one of the following:
 - 1.1. By a horizontal distance of not less than 24 inches (610 mm) where the wall or partition is constructed with individual noncommunicating stud cavities;
 - 1.2. By a horizontal distance of not less than the depth of the wall cavity where the wall cavity is filled with cellulose loose-fill, rockwool or slag mineral wool insulation;
 - 1.3. By solid fireblocking in accordance with Section 718.2.1;
 - 1.4. By protecting both outlet boxes with *listed* putty pads; or
 - 1.5. By other *listed* materials and methods.
2. Membrane penetrations by *listed* electrical boxes of any material, provided such boxes have been tested for use in fire-resistance-rated assemblies and are installed in accordance with the instructions included in the listing. The *annular space* between the wall membrane and the box shall not exceed 1/8 inch (3.1 mm) unless *listed* otherwise. Such boxes on opposite sides of the wall or partition shall be separated by one of the following:
 - 2.1. By the horizontal distance specified in the listing of the electrical boxes;
 - 2.2. By solid fireblocking in accordance with Section 718.2.1;
 - 2.3. By protecting both boxes with *listed* putty pads; or
 - 2.4. By other *listed* materials and methods.
3. Membrane penetrations by electrical boxes of any size or type, which have been *listed* as part of a wall opening protective material system for use in fire-resistance-rated assemblies and are installed in accordance with the instructions included in the listing. Membrane penetrations by boxes other than electrical boxes, provided such penetrating items and the *annular space* between the wall membrane and the box, are protected by an *approved membrane penetration firestop system* installed as tested in accordance with ASTM E 814 or UL 1479, with a minimum positive pressure differential of 0.01 inch (2.49 Pa) of water, and shall have an F and T rating of not less than the required *fire-resistance rating* of the wall penetrated and be installed in accordance with their listing.

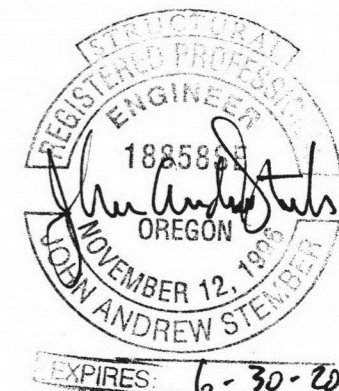

6-8-17

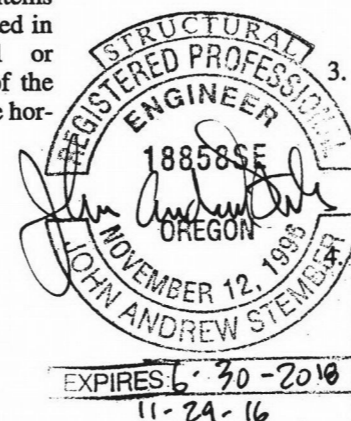
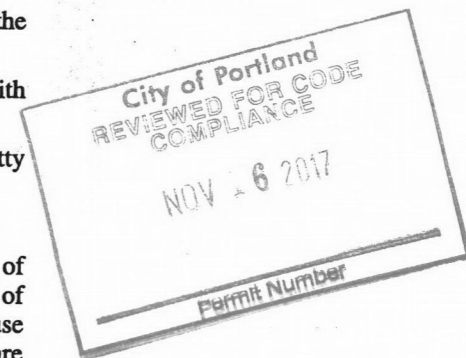

11-29-16

1419 Washington St.
Suite 100
Oregon City, Oregon 97045
Work: 503-657-9800
Cell: 503-449-3080
Andy@jasenginc.com

GABRIEL PARK APART. FIRE RESTORATION
HARBRO
7740 SW 45TH AVE.
PORTLAND, OR 97219

COPYRIGHT 2017 JAS ENGINEERING	DESIGN BY: JAS	DRAWN BY: DAS	JAS PROJ. NO.: 17-024	ISSUE DATE: 5/8/2017
-----------------------------------	-------------------	------------------	--------------------------	-------------------------

SHEET TITLE:
RATED FLOOR/
CEILING ASSEMBLIES

SHEET NO:
A-4.6

SCALES NOTED ON DRAWINGS ARE FOR 11"x17" SHEET. SCALE ACCORDINGLY FOR DIFFERENT SIZE SHEET.

STRUCTURAL NOTES

GENERAL STRUCTURAL NOTES

- THESE NOTES ARE GENERAL IN NATURE AND ARE INTENDED TO SET MINIMUM STANDARDS FOR CONSTRUCTION.
- ALL WORK SHALL BE IN STRICT CONFORMANCE WITH THE 2012 INTERNATIONAL BUILDING CODE (IBC) AS AMENDED BY THE STATE OF OREGON (2014 OSSC). ALL BUILDING ELEMENTS AND COMPONENTS AND COMPONENTS NOT SPECIFICALLY DETAILED IN THESE STRUCTURAL CONSTRUCTION DOCUMENTS SHALL BE FABRICATED AND CONSTRUCTED IN ACCORDANCE WITH THE MINIMUM STANDARDS CONTAINED IN SECTION 2308 - CONVENTIONAL LIGHT FRAME CONSTRUCTION OF THE IBC AS AMENDED BY THE STATE OF OREGON.
- THE CONTRACTOR SHALL VERIFY ALL DIMENSIONS AND ELEVATIONS BEFORE CONSTRUCTION. THE ARCHITECT AND ENGINEER SHALL BE NOTIFIED OF ANY DISCREPANCIES OR INCONSISTENCIES.
- THE CONTRACT STRUCTURAL DRAWINGS REPRESENT THE FINISHED STRUCTURE. METHODS, PROCEDURES, AND SEQUENCE OF CONSTRUCTION ARE THE RESPONSIBILITY OF THE CONTRACTOR. THE CONTRACTOR SHALL TAKE ALL NECESSARY PRECAUTIONS TO MAINTAIN AND ENSURE THE INTEGRITY OF THE STRUCTURE AT ALL STAGES OF CONSTRUCTION.
- CONSTRUCTION LOADS SHALL NOT EXCEED THE DESIGN LIVE LOAD FOR THE STRUCTURE. PROVIDE SHORING AND/OR BRACING WHERE LOADS EXCEED DESIGN CAPACITY AND WHERE STRUCTURES HAVE NOT ATTAINED DESIGN STRENGTH.

DESIGN LOADS

FLOOR LOADS:	
DL	15 PSF
LL	40 PSF
ROOF LOADS:	
ROOF DL	15 PSF
ROOF LL	25 PSF
SNOW LOADS:	
GROUND SNOW LOAD	25 PSF
FLAT ROOF SNOW LOAD	25 PSF, USE 25PSF MIN
SNOW EXPOSURE FACTOR, Ce	1.0
SNOW LOAD IMPORTANCE FACTOR, Is	1.0, CATEGORY II
THERMAL FACTOR, Ct	1.2
WIND DESIGN CRITERIA:	
BASIC WIND SPEED (ULTIMATE WIND SPEED)	120 MPH
WIND IMPORTANCE FACTOR, Iw	1.0, CATEGORY II
WIND EXPOSURE FACTOR	EXPOSURE B
EARTHQUAKE DESIGN CRITERIA:	
SEISMIC IMPORTANCE FACTOR, Ie	1.0, CATEGORY II
SEISMIC USE GROUP	GROUP I
SPECTRAL ACCELERATION, Ss	0.994g
SPECTRAL ACCELERATION, S1	0.428g
SITE CLASS	SITE CLASS D
SEISMIC DESIGN CATEGORY, SDC	CATEGORY D
RESPONSE MODIFICATION FACTOR, R	6.5
SEISMIC RESPONSE COEFFICIENT, Cs	0.113
DESIGN BASE SHEAR, V	SEE CALCULATIONS

SPECIAL INSPECTIONS

AN INDEPENDENT TESTING LABORATORY CHOSEN BY THE OWNER SHALL PROVIDE SPECIAL INSPECTIONS IN ACCORDANCE WITH CHAPTER 17 OF THE INTERNATIONAL BUILDING CODE FOR THE FOLLOWING AREAS OF WORK.

- CONCRETE: **(NOT REQUIRED)**
CYLINDER TESTS, SLUMP TESTS, AIR CONTENT DURING PLACEMENT OF REINFORCING STEEL & ANCHOR BOLTS DURING PLACEMENT OF CAST-IN-PLACE CONCRETE (CIP) (CONCRETE SPECIAL INSPECTION IS NOT REQUIRED FOR CONCRETE STRENGTHS LESS THAN 2500 PSI WHEN AN APPROVED MIX DESIGN IS SUBMITTED FOR REVIEW BY THE ENGINEER)
- ALL EPOXY ANCHORAGE (BOLTS AND REINFORCING)

THE FOLLOWING COMPANIES HAVE BEEN PRE-APPROVED FOR SPECIAL INSPECTION. ALTERNATIVES SHALL BE SUBMITTED TO AND APPROVED BY THE ENGINEER PRIOR TO USE:

CARLESON TESTING, INC 8430 SW HUNZIKER ROAD TIGARD, OREGON 97281 (503) 684-3460	MAYS TESTING ENGINEERS, INC. 7911 NE 33RD DRIVE, SUITE 190 PORTLAND, OREGON 97211 (503) 281-7579
PROFESSIONAL SERVICES-IND. (PSI) 6302 N. CUTLER CIRCLE, SUITE 480 PORTLAND, OREGON 97217 (503) 289-1778	CLAIR COMPANY 525 NW 2ND STREET CORVALLIS, OREGON 97330 (541) 758-1302

PER SPECIAL INSPECTION FORM

FOUNDATIONS

- REFER TO THE GEOTECHNICAL REPORT PREPARED BY _____ DATED _____ FOR SUBSURFACE CONDITIONS AND FOUNDATION RECOMMENDATIONS.
- FOOTINGS HAVE BEEN DESIGNED FOR AN ALLOWABLE BEARING PRESSURE OF 1,500 PSF.
- EARTH RETAINING WALLS HAVE BEEN DESIGNED FOR A LATERAL PRESSURE OF 35 PCF (ACTIVE).
- SLIDING RESISTANCE HAS BEEN DESIGNED USING AN ALLOWABLE PASSIVE EARTH PRESSURE OF 250 PCF AND A COEFFICIENT OF FRICTION OF 0.30.
- GRANULAR FILL: 3/4" OR 1 1/2" MINUS CRUSHED AGGREGATE BASE AS INDICATED OF UNIFORM GRADATION FROM COARSE TO FINE IN ACCORDANCE WITH SECTION 02630 OF THE STATE OF OREGON, DEPARTMENT OF TRANSPORTATION "STANDARD SPECIFICATIONS FOR HIGHWAY CONSTRUCTION". GRANULAR FILL SHALL BE PLACED IN LIFTS NOT TO EXCEED 8" LOOSE MEASURE AND COMPACTED TO NOT LESS THAN 95% RELATIVE COMPACTION AT OPTIMUM MOISTURE CONTENT +/- 2% AS DETERMINED BY ASTM D1557.
- FOOTINGS SHALL BE CARRIED INTO FIRM, NATURAL, UNDISTURBED, STABLE, NATIVE SOIL THAT IS FREE OF ORGANIC AND OTHER OBJECTIONABLE MATERIALS OR SHALL BE PLACED ON COMPACTED GRANULAR FILL.
- NO BACKFILL SHALL BE PLACED BEHIND CANTILEVERED WALLS UNTIL THE CONCRETE HAS ATTAINED 100% OF ITS SPECIFIED COMPRESSIVE STRENGTH.
- COMPACTION TESTING SHALL BE IN ACCORDANCE WITH ASTM D2922.

REINFORCED CONCRETE

- CEMENT: ASTM C150 TYPE I OR II.
- AGGREGATE: ASTM C33, 1-1/2" MINUS AT FOOTINGS AND 3/4" MINUS AT WALLS.
- WATER: IN CONFORMANCE WITH ASTM C94.
- WATER REDUCING ADMIXTURE: ASTM C490 TYPE A, OR F MID RANGE TYPE.
- AIR-ENTRAINING ADMIXTURE: ASTM C260.
- STRUCTURAL CONCRETE: $f'_c = 3,000$ PSI @ 28 DAYS. SLUMP SHALL BE 4" +/- 1". SLUMPS MAY BE INCREASED TO 8" MAXIMUM USING A MID-RANGE WATER REDUCER. AIR ENTRAINMENT SHALL BE 5% +/- 1% AT EXPOSED EXTERIOR CONCRETE. CONCRETE SHALL CONTAIN A WATER REDUCER. MAXIMUM WATER CEMENT RATIO SHALL BE .58 FOR 3,000 PSI CONCRETE. CONCRETE MATERIALS AND QUALITY SHALL BE IN ACCORDANCE WITH CHAPTERS 3 AND 5 RESPECTIVELY OF ACI 318 "BUILDING CODE REQUIREMENTS FOR STRUCTURAL CONCRETE".
- TRANSPORTING OF READY-MIX CONCRETE SHALL BE IN ACCORDANCE WITH ASTM C94 "SPECIFICATION FOR READY-MIXED CONCRETE" AND CONCRETE PLACEMENT, CONSOLIDATION AND CURING SHALL BE IN ACCORDANCE WITH SECTION 5 OF ACI 301 "SPECIFICATIONS FOR STRUCTURAL CONCRETE".
- HOT-WEATHER CONCRETING SHALL BE IN ACCORDANCE WITH ACI 305 "HOT WEATHER CONCRETING". COLD WEATHER CONCRETING SHALL BE IN ACCORDANCE WITH ACI 306 ACI 306 "COLD WEATHER CONCRETING" AND ACI 306.1 "STANDARD SPECIFICATION FOR COLD WEATHER CONCRETING".
- STRENGTH TESTING OF CONCRETE SHALL BE IN ACCORDANCE WITH SECTION 1.6 OF ACI 301 "SPECIFICATIONS FOR STRUCTURAL CONCRETE". CONCRETE TESTS SHALL BE MADE FOR EACH 100 CU. YDS. OF CONCRETE PLACED.

REINFORCING STEEL

- REINFORCING STEEL: ASTM A 615 GRADE 60 DEFORMED BARS.
- FABRICATION AND PLACEMENT SHALL BE IN ACCORDANCE WITH CRSI MSP-1 "MANUAL OF STANDARD PRACTICE" AND SECTION 3 OF ACI 301 "SPECIFICATIONS FOR STRUCTURAL CONCRETE".
- REINFORCING STEEL LAP SPLICES NOT OTHERWISE INDICATED SHALL BE ACI STANDARD CLASS B IF SPLICED AT THE SAME LOCATION OR CLASS A IF SPLICES ARE STAGGERED BETWEEN ADJACENT BARS ONE LAP LENGTH MINIMUM.
- UNLESS OTHERWISE INDICATED, MINIMUM CLEARANCE FOR REINFORCING STEEL SHALL BE 3" FOR CONCRETE CAST AGAINST EARTH; FOR CONCRETE EXPOSED TO EARTH OR WEATHER, 1 1/2" FOR #5 AND SMALLER BARS AND 2" FOR #6 AND LARGER BARS. INSTALL WITH PROPER BAR SUPPORTS PRIOR TO CONCRETE PLACEMENT.
- PROVIDE CORNER BARS OF THE SAME SIZE AND SPACING AS THE HORIZONTAL REINFORCEMENT.

FORM WORK

- CONSTRUCTION, SHORING AND BRACING OF FORMWORK SHALL BE IN ACCORDANCE WITH SECTION 2 OF ACI 301 "SPECIFICATIONS FOR STRUCTURAL CONCRETE".
- THE CONTRACTOR SHALL BE RESPONSIBLE FOR DESIGN, CONSTRUCTION, SEQUENCING AND SAFETY OF ALL FORMWORK AND SHORING.

CONCRETE ACCESSORIES

- PREMOLDED JOINT FILLER: ASTM D1751 ASPHALT-SATURATED FIBER TYPE.
- SMOOTH DOWELS: ASTM A36 ROUND BARS. PROVIDE WITH SLEEVES AT ONE SIDE OF THE JOINT.

SUBMITTALS

- THE CONTRACTOR SHALL SUBMIT TO THE ENGINEER PRIOR TO FABRICATION/INSTALLATION ALL SHOP DRAWINGS, PRODUCT DATA, ETC. NECESSARY FOR PERFORMANCE OF THE WORK IN THE SHOP AND AT THE SITE.
- REINFORCING STEEL SHOP/PLACEMENT DRAWINGS
 - CONCRETE MIX DESIGNS

STRUCTURAL STEEL (NOT USED)

- STRUCTURAL STEEL SHALL CONFORM TO ASTM A53, GRADE B FOR PIPE SECTIONS, ASTM A500, GRADE B FOR TUBE SECTIONS AND ASTM A572, GRADE 50 FOR OTHER STRUCTURAL SHAPES. EXCEPT AS NOTED ALL STRUCTURAL STEEL IS TO BE PAINTED AFTER FABRICATION. ALL STRUCTURAL STEEL SHALL BE FABRICATED AND ERECTED IN CONFORMANCE WITH THE AISC MANUAL OF STEEL CONSTRUCTION, CURRENT EDITION. NO HOLES OTHER THAN THOSE SPECIFICALLY DETAILED SHALL BE ALLOWED THROUGH STRUCTURAL STEEL MEMBERS. NO CUTTING OR BURNING OF STRUCTURAL STEEL WILL BE PERMITTED WITHOUT PERMISSION OF THE ENGINEER.
- HIGH STRENGTH BOLTING SHALL BE BOLTS CONFORMING TO ASTM A325 HIGH STRENGTH STEEL UNLESS OTHERWISE SHOWN. ALL JOINT CONTACT SURFACES SHALL BE CLEAN AND FREE FROM OIL DIRT AND PAINT. USE TURN-OF-THE-NUT METHOD OR LOAD INDICATION WASHERS.
- STRUCTURAL STEEL WELDING SHALL BE DONE BY AWS CERTIFIED WELDERS AND SHALL CONFORM TO AWS D1.1 LATEST EDITION. ALL BUT WELDS ARE COMPLETE PENETRATION UNLESS NOTED OTHERWISE. WELD FILLER METAL SHALL BE AWS A5.1 OF A5.5 E70XX ELECTRODES.
- SPECIAL INSPECTIONS (OWNER FURNISHED) IS REQUIRED IN ACCORDANCE WITH THE IBC ON THE FOLLOWING PORTIONS OF THE WORK.
 - ALL STRUCTURAL STEEL WELDING NOT PERFORMED IN AN APPROVED SHOP
 - ALL STRUCTURAL FIELD WELDING
 - ALL HIGH STRENGTH BOLTING
 - EPOXY AND EXPANSION ANCHORS INSTALLED IN CONCRETE

SHOP DRAWING SUBMITTALS

- STRUCTURAL STEEL
- MATERIAL CERTIFICATIONS FOR STRUCTURAL STEEL, WELDING RODS AND BOLTS
- MASONRY AND CONCRETE REINFORCEMENT
- MATERIAL CERTIFICATIONS FOR MASONRY BLOCKS, GROUTING AND STEEL REINFORCEMENT
- MANUFACTURED WOOD TRUSSES

RECEIVED
AUG 08 2017
BDS
DOCUMENT SERVICES

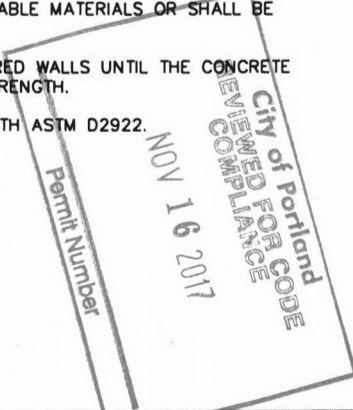

SCALES NOTED ON DRAWINGS ARE FOR 11"x17" SHEET. SCALE ACCORDINGLY FOR DIFFERENT SIZE SHEET.

S-1.0a SHEET NO.	STRUCTURAL NOTES SHEET TITLE	COPYRIGHT 2017 JAS ENGINEERING	GABRIEL PARK APART. FIRE RESTORATION HARBRO 7740 SW 45TH AVE, PORTLAND, OR 97219		1419 Washington St, Suite 100 Oregon City, Oregon 97045 Work: 503-657-9800 Cell: 503-449-3080 Andy@jasenginc.com
	DESIGN BY:	JAS			
	DRAWN BY:	DAS			
	JAS PROJ. NO:	17-024			
ISSUE DATE:	5/8/2017				

DESIGNATES TYPICAL SHEAR PANEL CONSTRUCTION

SHEARWALL SCHEDULE							
MARK	SHEATHING	FASTENERS	● EDGE	● FIELD	ANCHOR BOLTS	SOLE PLATE	NOTES
A	15/32" CDX 260#/FT.	COMMON NAILS	8d ● 6" O.C.	8d ● 12" O.C.	5/8" DIA. ● 48" O.C.	3-16d ● 16" O.C.	w/ 3x3x1/4 PLATE WASHERS ● A.B.
B	15/32" CDX 380#/FT.	COMMON NAILS	8d ● 4" O.C.	8d ● 12" O.C.	5/8" DIA. ● 18" O.C.	3-16d ● 16" O.C.	w/ 3x3x1/4 PLATE WASHERS ● A.B.
C	15/32" CDX 490#/FT.	COMMON NAILS	8d ● 3" O.C.	8d ● 12" O.C.	5/8" DIA. ● 24" O.C.	4-20d ● 16" O.C.	w/ 3x3x1/4 PLATE WASHERS ● A.B. IN 2x SILL PLATE
D	15/32" CDX 640#/FT.	COMMON NAILS	8d ● 2" O.C.	8d ● 12" O.C.	5/8" DIA. ● 18" O.C.	3-20d ● 8" O.C.	w/ 3x3x1/4 PLATE WASHERS ● A.B. IN 2x SILL PLATE

NOTES: USE 5/8" DIA. ANCHOR BOLTS WITH SIMPSON SET XP ADHESIVE. EMBED 7" MIN. AT NOTED SPACING IN EXISTING CONCRETE WALL.

(USE 2x ANCHOR BOLTS FOR SW EACH SIDE)

(USE 2x NAILING REQUIRED FOR SW EACH SIDE)

DESIGNATES TYPICAL HOLDOWN TYPE

HOLDOWN SCHEDULE (SEE NOTE)		
MARK	HOLDOWN	NOTES
1	MST 37	w/ MIN. DOUBLE STUDS 1,725#
2	HDU2 - SDS2.5 SSTB 16 13" EMBED	w/ MIN. DOUBLE STUDS 3,075#
3	MST 48	w/ MIN. 4x POSTS 3,215#
4	HDU4 - SDS2.5 SB1x24 18" EMBED	w/ MIN. 4x POSTS 4,565#
5	HDU5 - SDS2.5 SB1x24 18" EMBED	w/ MIN. 4x POSTS 5,645#
6	MST 60	w/ MIN. 4x POSTS 4,600#
8	HDU8 - SDS2.5 SSTB 36 29" EMBED	w/ MIN. 6x POSTS 7,870#
11	HDU11 - SDS2.5 SB1x30 24" EMBED	w/ MIN. 6x POSTS 9,535#
12	(2) MST172 (ONE EACH SIDE)	w/ MIN. 6x POSTS 10,160# DFIR POSTS
14	HDU 14-SDS2.5	w/ MIN. 6x POSTS 14,445#

NOTES: FOR HDU2 & HDU5 USE 5/8" DIA. ANCHOR W/ SIMPSON SET XP ADHESIVE EMBED 10" MIN. FOR HDU8 & HDU11 USE 7/8" DIA. ANCHOR W/ SIMPSON SET XP ADHESIVE EMBED 15" MIN.

STRUCTURAL PANEL NOTES

- THE LOCATION OF REQUIRED STRUCTURAL PANELS HAVE BEEN NOTED FOR CLARITY.
- ALL EXTERIOR WALLS SHALL BE OF TYPE A CONSTRUCTION EXCEPT AS NOTED OTHERWISE.
- SWA SHALL HAVE 2-INCH NOMINAL FRAMING AND SWB, SWC & SWD SHALL BE BACKED WITH 3-INCH NOMINAL OR WIDER FRAMING AT ALL PANEL EDGES. PANELS MAY BE INSTALLED EITHER HORIZONTALLY OR VERTICALLY, UNLESS OTHERWISE NOTED. PANELS SHALL BE INSTALLED ON STUDS SPACED A MAXIMUM 16" ON CENTER.
- HOLDOWNS OCCUR AT ENDS OF STRUCTURAL PANELS AND SHALL FASTEN TO A MIN. OF (2) STUDS UNLESS OTHERWISE NOTED. CONNECTION HARDWARE IS BY THE SIMPSON COMPANY OF SAN LEANDRO, CA. ALL STEEL CONNECTORS SHALL BE GALVANIZED OR BY SOME METHOD MADE CORROSION RESISTANT, UNLESS OTHERWISE INDICATED. PROVIDE BOLTED OR NAILED CONNECTIONS FOR THE MAXIMUM CAPACITY UNLESS NOTED OTHERWISE. CONNECTORS IN CONTACT WITH PRESSURE TREATED WOOD SHALL BE EITHER POST HOT-DIP GALVANIZED OR STAINLESS STEEL.
- WOOD STRUCTURAL PANELS SHALL BE 15/32" C-D INTERIOR-TYPE BONDED WITH EXTERIOR GLUE (CDX) CONFORMING TO APA REQUIREMENTS FOR WALL SHEATHING OR AS INDICATED IN THESE PLANS. PARTICLEBOARD AND OSB ARE NOT PERMITTED. MINIMUM NAILING IS 8d ● 6" O.C. AT PANEL EDGES AND 8d ● 12" O.C. IN THE FIELD. ALL NAILS ARE COMMON OR GALVANIZED BOX NAILS. BLOCKING IS REQUIRED AT PANEL JOINTS UNLESS OTHERWISE NOTED.
- CONNECT RIM JOIST / BLOCKING TO WALL TOP PLATE AS FOLLOWS: SWA SIMPSON A35 ● 16" O.C.; SWB SIMPSON A35 ● 12" O.C.; SWC (2) SIMPSON A 35 ● 16" O.C.; SWD (2) SIMPSON A 35 ● 12" O.C.
- SPECIAL INSPECTION (OWNER FURNISHED) IS REQUIRED IN ACCORDANCE WITH THE IBC ON THE FOLLOWING PORTIONS OF WORK.
-ALL SHEAR WALLS AND FLOOR DIAPHRAGMS WITH EDGE NAILING LESS THAN 4" OC.

MANUFACTURED WOOD BEAMS & JOISTS

- ROOF AND FLOOR FRAMING DESIGNATED TJI, LVL, TJH, PSL AND MICROLAM SHALL BE MANUFACTURED BY THE TRUSS JOIST CORPORATION.
- ALTERNATE MANUFACTURER MUST BE APPROVED BY THE ENGINEER. PROVIDE SHOP DRAWINGS AND ENGINEERING BEARING THE STAMP OF A REGISTERED PROFESSIONAL ENGINEER LICENSED IN THE STATE OF OREGON.
- MANUFACTURER SHALL SUPPLY JOISTS, BRIDGING, HANGERS, BLOCKING, NOTCHED PLATES AND ALL OTHER ACCESSORIES NECESSARY FOR THE PROPER ERECTION AND PERFORMANCE OF THE PRODUCT.
- THE PRODUCT SHALL BE ERECTED AND BRIDGED IN ACCORDANCE WITH THE MANUFACTURER'S INSTRUCTIONS AND SPECIFICATIONS. THE MANUFACTURER SHALL INSPECT INSTALLED ITEMS FOR PROPER INSTALLATION.
- MICROLAM BEAMS, MINIMUM DESIGN VALUES
F_b = 2,600 PSI; F_v = 285 PSI; F_c = 750 PSI; E = 2,000 KSI
- PARALLAM BEAMS, MINIMUM DESIGN VALUES
F_b = 2,900 PSI; F_v = 290 PSI; F_c = 750 PSI; E = 2,200 KSI

GLUED LAMINATED BEAMS (GLB)

- GLULAM BEAMS ARE TO BE MANUFACTURED, TRANSPORTED, AND INSTALLED IN ACCORDANCE WITH THE REQUIREMENTS OF THE AITC.
- SPECIFY ARCHITECTURAL GRADE FINISH AND EXTERIOR ADHESIVE UNLESS NOTED OTHERWISE. USE 24F-V4 FOR SIMPLE SPANS AND 24F-V8 FOR CONTINUOUS SPANS AND CANTILEVER CONDITIONS.
- MINIMUM DESIGN VALUES:
24F-V4: F_b = 2,400 PSI; F_v = 265 PSI; F_c = 1650 PSI; E = 1,700 KSI
24F-V8: F_b = 2,400 PSI; F_v = 265 PSI; F_c = 1650 PSI; E = 1,700 KSI

SOLID SAWN LUMBER

- STRUCTURAL LUMBER SHALL BE DOUGLAS FIR CONFORMING TO WMPA GRADING RULES.
- MINIMUM GRADES ARE, EXCEPT AS NOTED OTHERWISE:
STRUCTURAL JOISTS AND PLANKS - #2
BEAMS AND STRINGERS - #1
POSTS AND TIMBERS - #1
STUDS - #2
- DOUBLE JOISTS BELOW ALL PARALLEL WALLS AND/OR PARTITIONS.
- NOTCHING IS NOT PERMITTED IN JOISTS, RAFTERS, BEAMS, LINTELS, COLUMNS, TRUSSES AND BRACING MEMBERS.
- PRESSURE TREATED LUMBER SHALL CONFORM TO THE AWPA. ALL LUMBER IN CONTACT WITH CONCRETE SHALL BE PRESSURE TREATED WITH ACZA TO A MINIMUM RETENTION OF 0.25 POUNDS PER CUBIC FOOT BY ASSAY.
- NAILING SHALL BE WITH COMMON NAILS IN CONFORMANCE WITH TABLE 2304.9., 2006 IBC UNLESS NOTED OTHERWISE.
- PROVIDE STANDARD 3"x 3" X 0.229" STEEL PLATE WASHERS UNDER ALL INTERMEDIATE ANCHOR BOLT HEADS AND NUTS AT THE SILL PLATE. USE STANDARD WASHERS FOR ALL OTHER BOLT HEADS AND NUTS IN CONTACT WITH WOOD.

PREMANUFACTURED CONNECTION HARDWARE

- CONNECTION HARDWARE IS BY THE SIMPSON COMPANY OF SAN LEANDRO, CA. ALL STEEL CONNECTORS SHALL BE GALVANIZED OR BY SOME METHOD BE MADE CORROSION RESISTANT, UNLESS OTHERWISE INDICATED.
- PROVIDE BOLTED OR NAILED CONNECTIONS FOR THE MAXIMUM CAPACITY UNLESS OTHERWISE NOTED.
- CONNECTORS IN CONTACT WITH PRESSURE TREATED WOOD SHALL BE EITHER POST HOT DIPPED GALVANIZED OR STAINLESS STEEL.

SHEATHING

- CONSTRUCTION PANELS SHALL BE IDENTIFIED WITH THE APPROPRIATE TRADEMARK OF THE AMERICAN PLYWOOD ASSOCIATION (APA), AND SHALL MEET THE REQUIREMENTS OF THE LATEST EDITION OF THE U.S. PRODUCT STANDARD PS1 OR APA PERFORMANCE STANDARDS PRP-108.
- MINIMUM PANEL THICKNESS SHALL BE 15/32" C-D EXTERIOR GLUE OR AS INDICATED ON THE PLANS. PARTICLEBOARD IS NOT PERMITTED.
- MINIMUM NAILING IS 8d ● 6" AT PANEL EDGES AND 8d ● 12" IN THE FIELD. ALL NAILS ARE GALVANIZED COMMON OR BOX NAILS. BLOCKING IS REQUIRED AT PANEL EDGES WHERE NOTED ON THE PLANS.

MANUFACTURED ROOF TRUSSES

- MANUFACTURED ROOF TRUSSES SHALL BE AT 24" CENTERS AND SHALL HAVE A MINIMUM OF 2X4 TOP CHORDS AND BOTTOM CHORDS FOR WOOD TRUSSES.
- TRUSSES SHALL BE DESIGNED FOR SPECIFIED ROOF LOADS. STRUCTURAL CALCULATIONS SHALL BE SEALED BY AN OREGON LICENSED PROFESSIONAL ENGINEER AND SUBMITTED TO THE ENGINEER FOR REVIEW AND APPROVAL THEN THE BUILDING DEPARTMENT PRIOR TO FABRICATION AND INSTALLATION.
- MANUFACTURER SHALL PROVIDE BRACING, BLOCKING, HANGERS, HOLDOWNS AND ALL ACCESSORIES REQUIRED FOR PROPER INSTALLATION.
- SHOP DRAWINGS SHALL PROVIDE PLACING AND ERECTION DIRECTION TO THE INSTALLER. CALCULATIONS AND SHOP DRAWINGS SHALL INCLUDE COMMON IDENTIFYING MARKS TO FACILITATE SHOP DRAWING REVIEW.

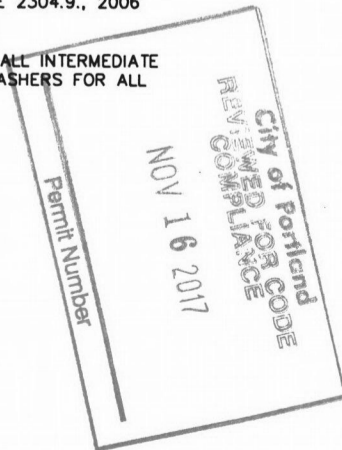

SCALES NOTED ON DRAWINGS ARE FOR 11"x17" SHEET. SCALE ACCORDINGLY FOR DIFFERENT SIZE SHEET.

SHEET NO. S-1.0b	STRUCTURAL NOTES		COPYRIGHT 2017 JAS ENGINEERING		GABRIEL PARK APART. FIRE RESTORATION HARBRO 7740 SW 45TH AVE, PORTLAND, OR 97219	JAS ENGINEERING	1419 Washington St, Suite 100 Oregon City, Oregon 97045 Work: 503-657-9800 Cell: 503-449-3080 Andy@jasenginc.com
	DESIGN BY:	JAS					
	DRAWN BY:	DAS					
	JAS PROJ. NO:	17-024					
		ISSUE DATE:	5/8/2017				

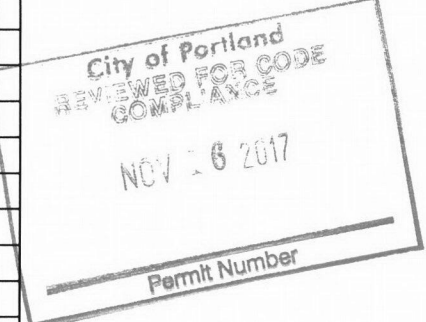
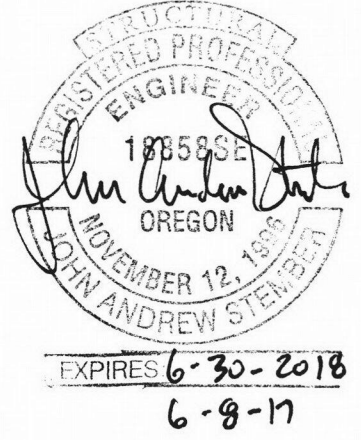
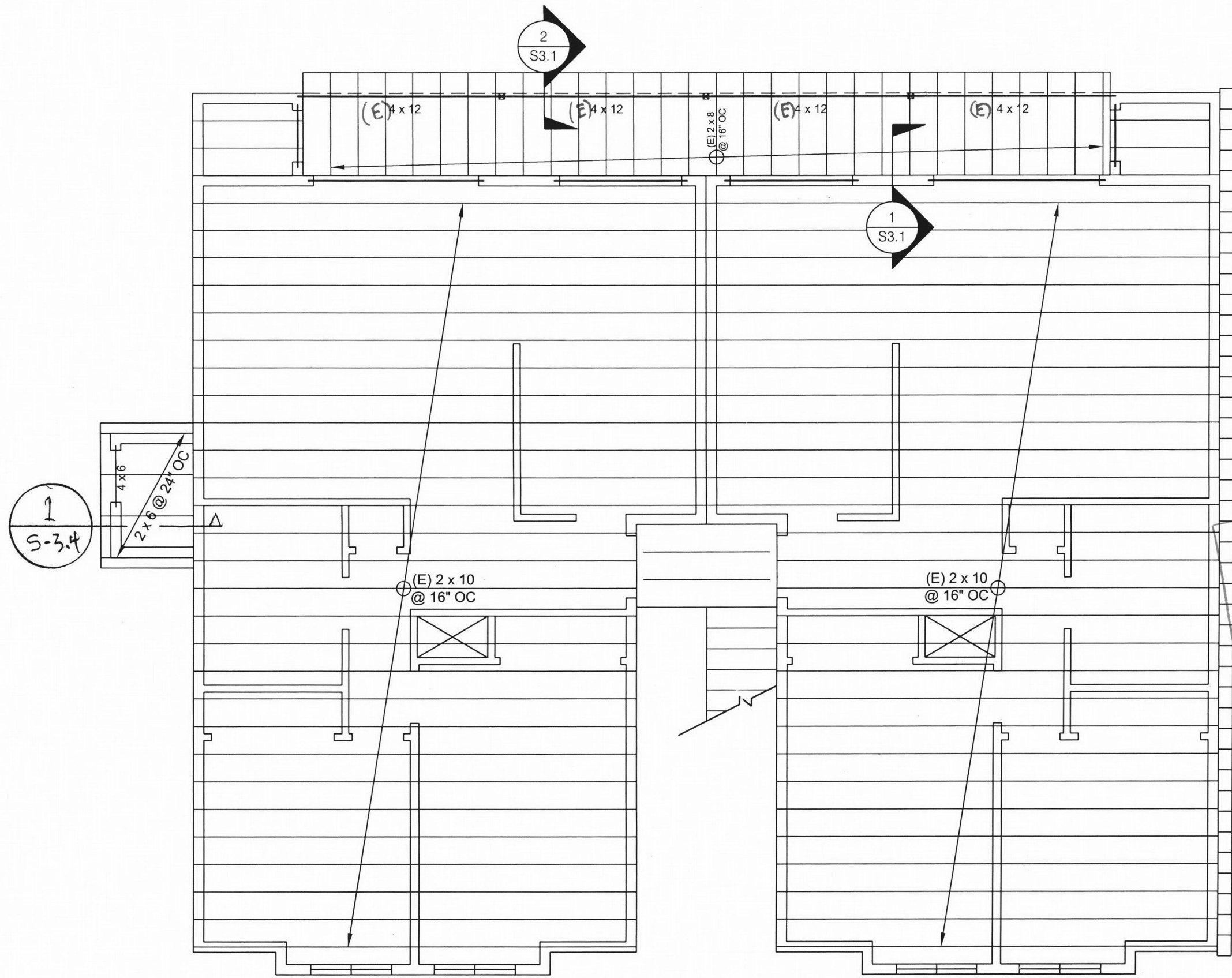

**CONTRACTOR TO FIELD
VERIFY ALL DIMENSIONS**

UPPER FLOOR FRAMING PLAN
3/16" = 1'-0"

SCALES NOTED ON DRAWINGS ARE FOR 11"X17" SHEET. SCALE ACCORDINGLY FOR DIFFERENT SIZE SHEET.

1419 Washington St.
Suite 100
Oregon City, Oregon 97045
Work: 503-657-9800
Cell: 503-449-3080
Andy@jasenginc.com



GABRIEL PARK APART. FIRE RESTORATION
HARBRO
7740 SW 45TH AVE,
PORTLAND, OR 97219

COPYRIGHT 2017 JAS ENGINEERING	
DESIGN BY: JAS	DRAWN BY: DAS
JAS PROJ. NO: 17-024	ISSUE DATE: 5/8/2017

SHEET TITLE: UPPER FLOOR FRAMING PLAN
SHEET NO: S-2.1

1/2" CDX PLYWOOD
ROOF SHEATHING
8d GALV. NAILS @
6" OC EDGE &
12" OC FIELD

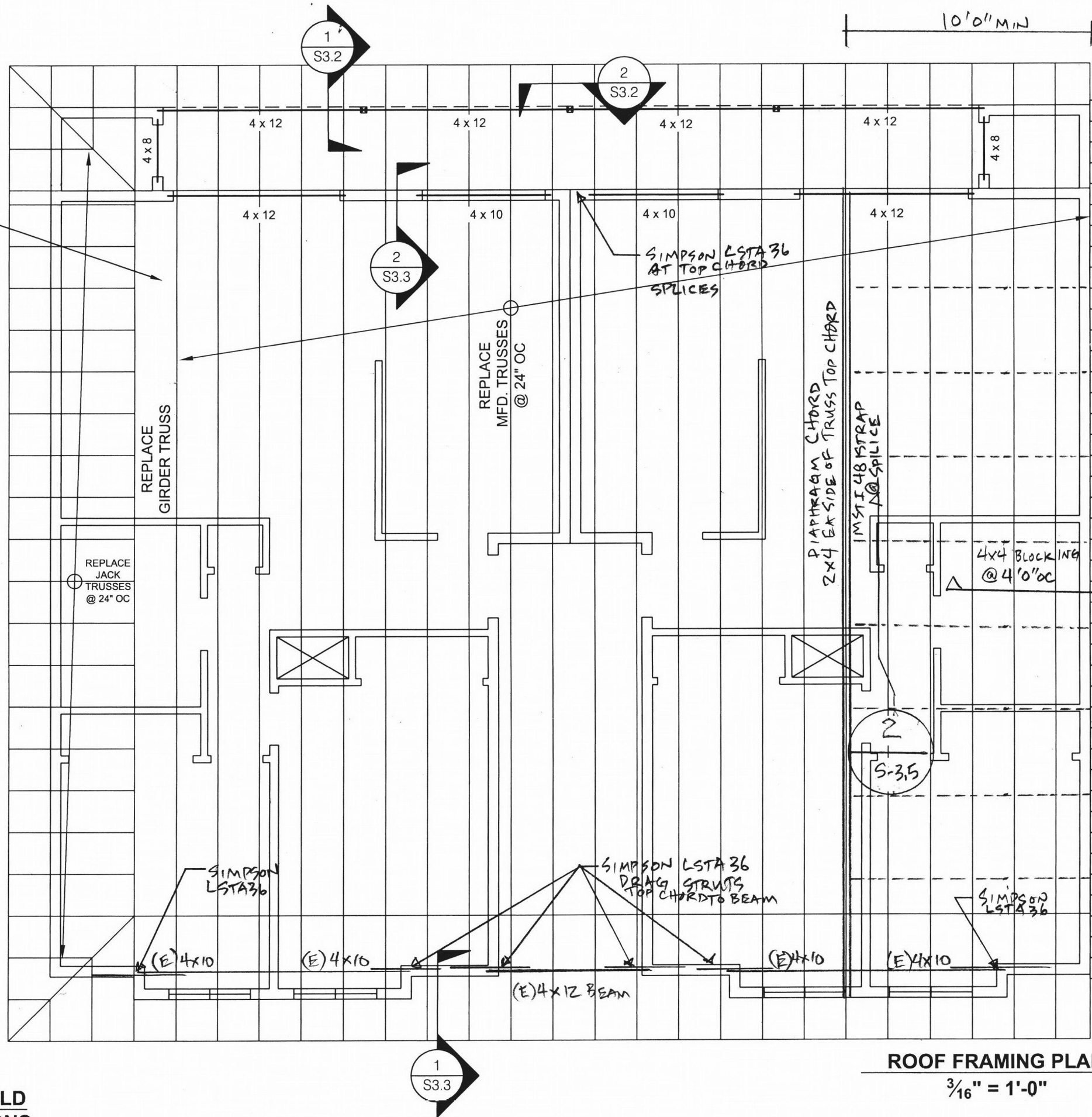

10'0" MIN

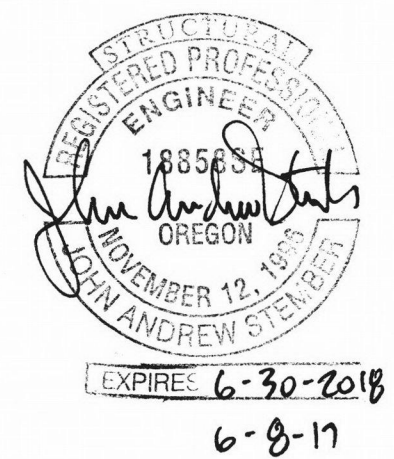

1
S-3.5

RECEIVED
AUG 08 2017
BDS
DOCUMENT SERVICES

City of Portland
REVIEWED FOR CODE
COMPLIANCE
NOV 16 2017
Permit Number

ROOF FRAMING PLAN
3/16" = 1'-0"

CONTRACTOR TO FIELD
VERIFY ALL DIMENSIONS

SCALES NOTED ON DRAWINGS ARE FOR
11"x17" SHEET. SCALE ACCORDINGLY
FOR DIFFERENT SIZE SHEET.

1419 Washington St,
Suite 100
Oregon City, Oregon 97045
Work: 503-657-9800
Cell: 503-449-3080
Andy@jasenginc.com



GABRIEL PARK APART. FIRE RESTORATION
HARBRO
7740 SW 45TH AVE,
PORTLAND, OR 97219

COPYRIGHT 2017 JAS ENGINEERING	JAS	DAS	17-024	5/8/2017
DESIGN BY:	JAS	DAS		
DRAWN BY:				
JAS PROJ. NO.:				
ISSUE DATE:				

SHEET TITLE: ROOF FRAMING PLAN
SHEET NO.: S-2.2

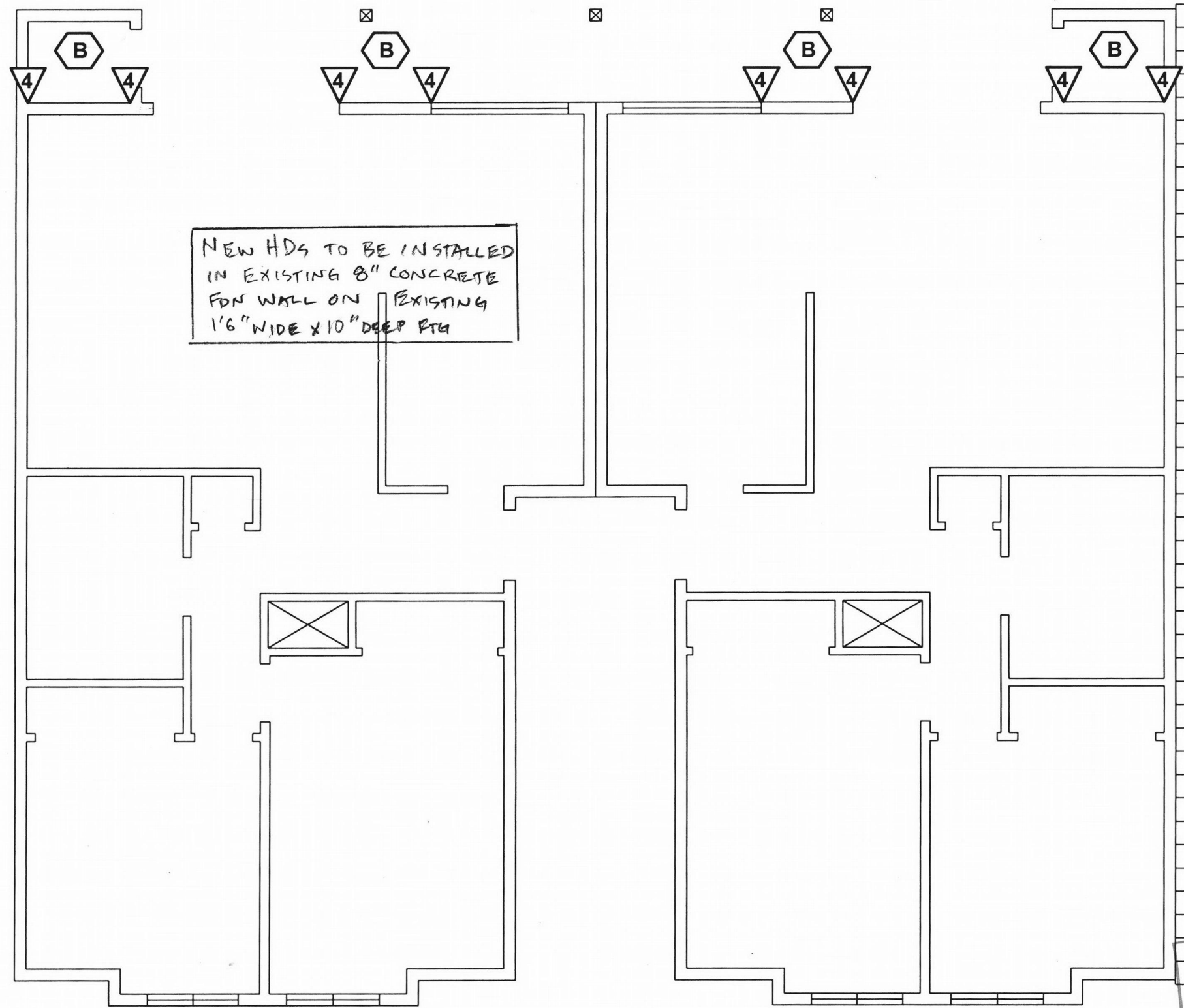

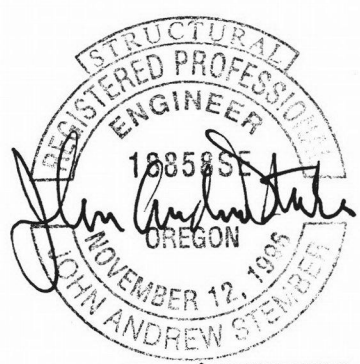

NEW HDs TO BE INSTALLED
 IN EXISTING 8" CONCRETE
 FDN WALL ON EXISTING
 1/6" WIDE X 10" DEEP RTG



EXPIRES: 6-30-2018
 6-8-17

RECEIVED
 AUG 08 2017
 BDS
 DOCUMENT SERVICES

City of Portland
 REVIEWED FOR CODE
 COMPLIANCE
 NOV 16 2017
 Permit Number

-  SHEAR WALLS PER SCHED. S-1.0b
-  HOLD DOWNS PER SCHED. S-1.0b

LOWER SHEAR WALL PLAN
 $3/16" = 1'-0"$

SCALES NOTED ON DRAWINGS ARE FOR
 11"X17" SHEET. SCALE ACCORDINGLY
 FOR DIFFERENT SIZE SHEET.

1419 Washington St.
 Suite 100
 Oregon City, Oregon 97045
 Work: 503-657-9800
 Cell: 503-449-3080
 Andy@jasenginc.com





GABRIEL PARK APART. FIRE RESTORATION
 HARBRO
 7740 SW 45TH AVE,
 PORTLAND, OR 97219

COPYRIGHT 2017 JAS ENGINEERING	DESIGN BY:	JAS
	DRAWN BY:	DAS
	JAS PROJ. NO.:	17-024
	ISSUE DATE:	5/8/2017

SHEET TITLE:
LOWER SHEAR WALL PLAN

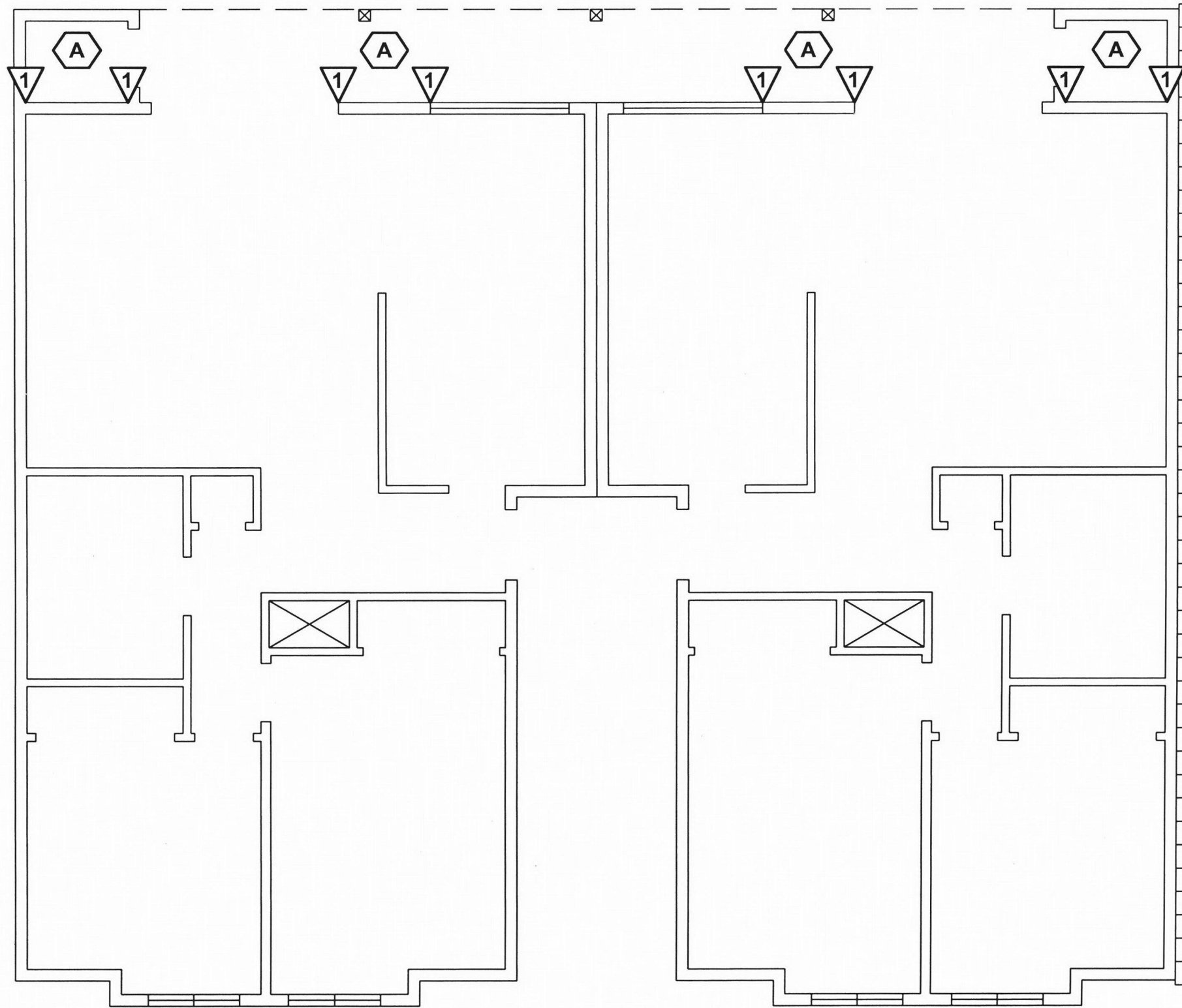
SHEET NO.
S-2.3



-  SHEAR WALLS PER SCHED. S-1.0b
-  HOLD DOWNS PER SCHED. S-1.0b

UPPER SHEAR WALL PLAN

$\frac{3}{16}'' = 1'-0''$

SCALES NOTED ON DRAWINGS ARE FOR 11"X17" SHEET. SCALE ACCORDINGLY FOR DIFFERENT SIZE SHEET.

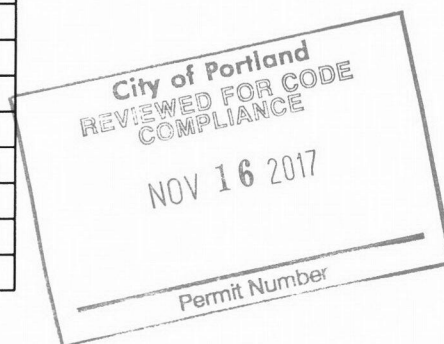
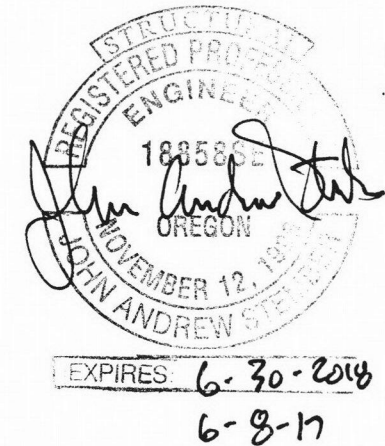

1419 Washington St,
Suite 100
Oregon City, Oregon 97045
Work: 503-657-9800
Cell: 503-449-3080
Andy@jasenginc.com



GABRIEL PARK APART. FIRE RESTORATION
HARBRO
7740 SW 45TH AVE,
PORTLAND, OR 97219

COPYRIGHT 2017 JAS ENGINEERING	DESIGN BY:	JAS	DAS	17-024	5/8/2017
	DRAWN BY:				
JAS PROJ. NO:					
ISSUE DATE:					

SHEET TITLE:
UPPER SHEAR WALL PLAN

SHEET NO:
S-2.4

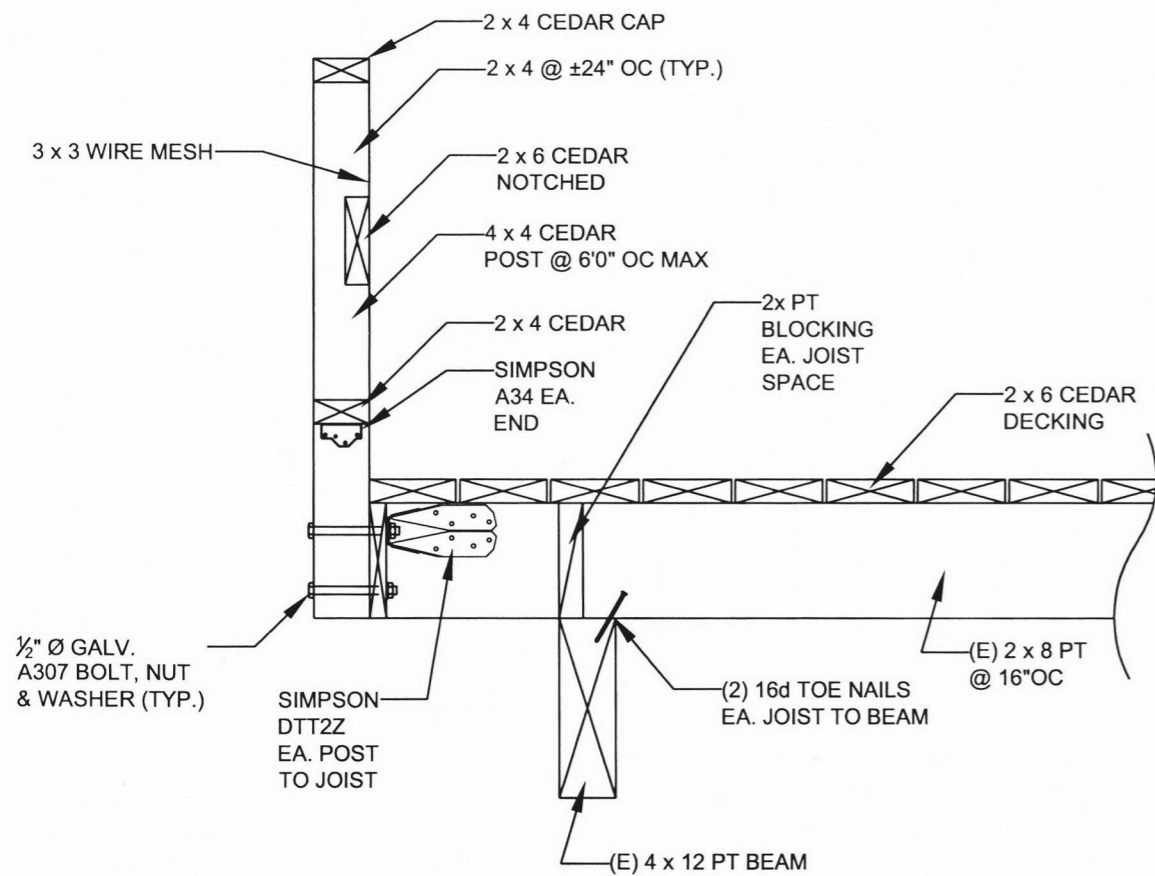

NOTE
PROVIDE END TREATMENT FOR ALL CUT ENDS

2
S-3.1 (E) DECK JOIST TO (E) BEAM
1"=1'0"

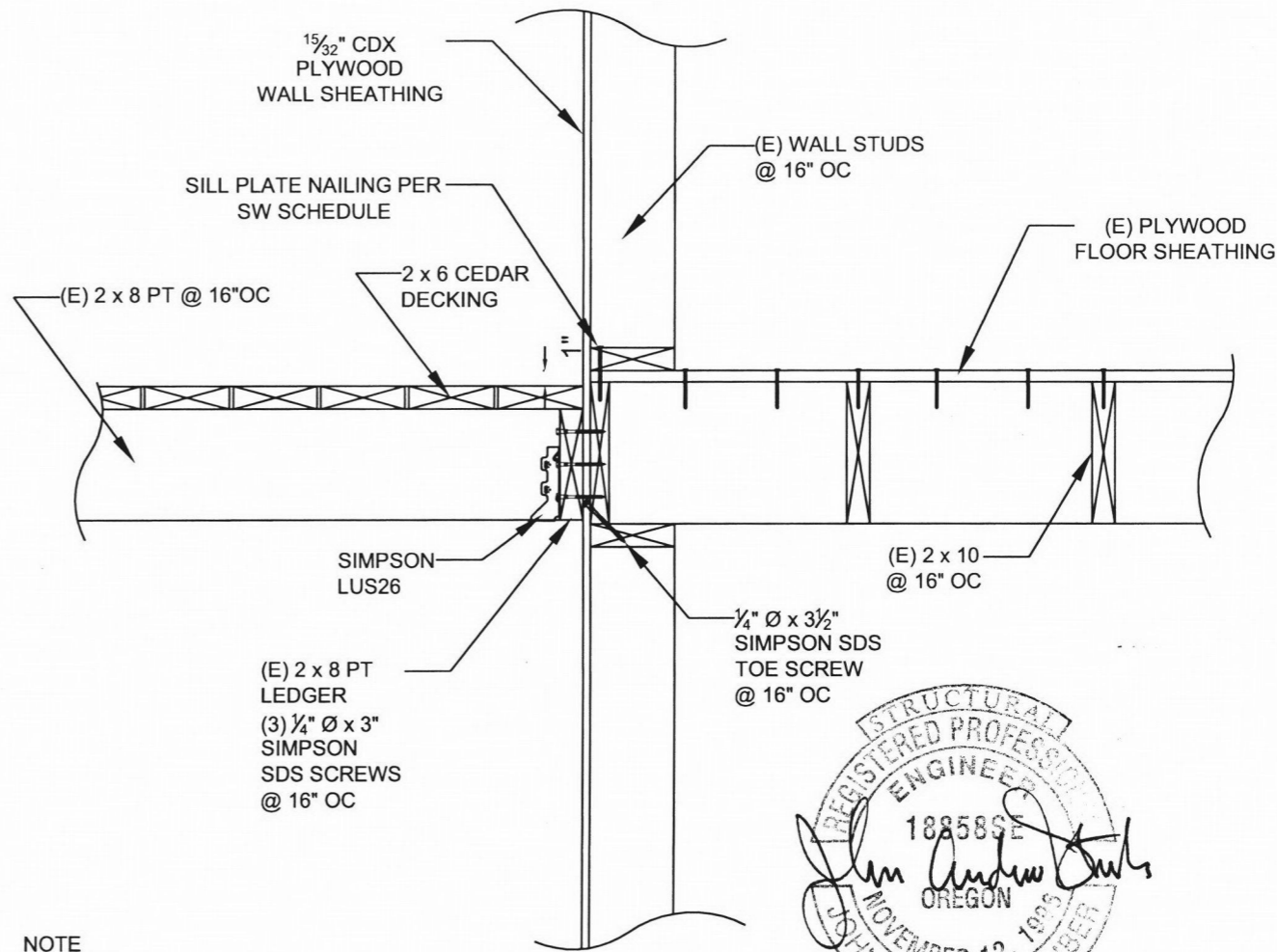

NOTE
PROVIDE END TREATMENT FOR ALL CUT ENDS

1
S-3.1 (E) DECK JOIST AT (E) LEDGER
1"=1'0"

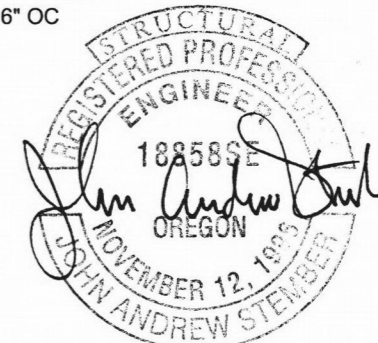

EXPIRES: 6-30-2018
6-8-17

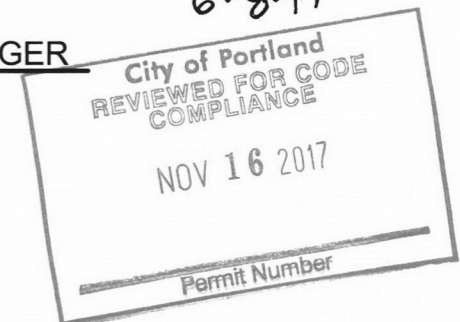

1419 Washington St,
Suite 100
Oregon City, Oregon 97045
Work: 503-657-9800
Cell: 503-449-3080
Andy@jasenginc.com



GABRIEL PARK APART. FIRE RESTORATION
HARBRO
7740 SW 45TH AVE,
PORTLAND, OR 97219

COPYRIGHT 2017 JAS ENGINEERING	DESIGN BY: JAS	DRAWN BY: DA5	JAS PROJ. NO: 17-024	ISSUE DATE: 5/8/2017
-----------------------------------	----------------	---------------	----------------------	----------------------

SHEET TITLE:
**FLOOR
DETAIL**

SHEET NO:
S-3.1

SCALES NOTED ON DRAWINGS ARE FOR 11"X17" SHEET. SCALE ACCORDINGLY FOR DIFFERENT SIZE SHEET.

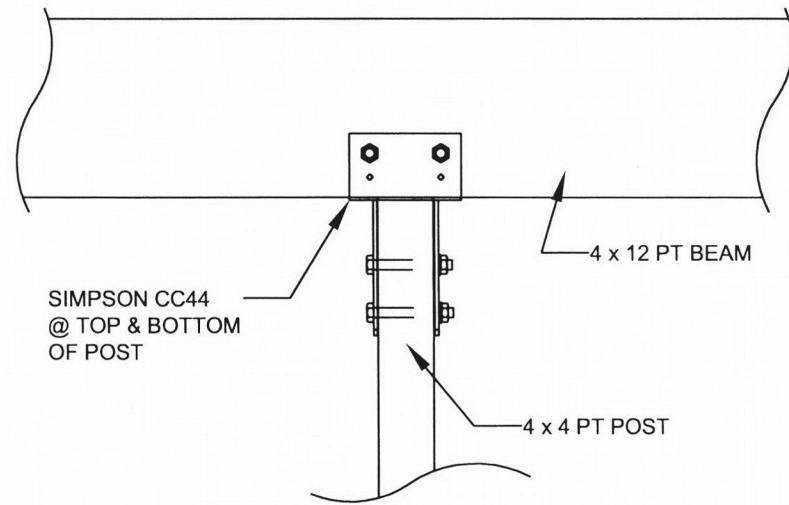

SIMPSON CC44
@ TOP & BOTTOM
OF POST

4 x 12 PT BEAM

4 x 4 PT POST

NOTE

PROVIDE END TREATMENT
FOR ALL CUT ENDS

2
S-3.2 BEAMS TO POST
1"=1'0"

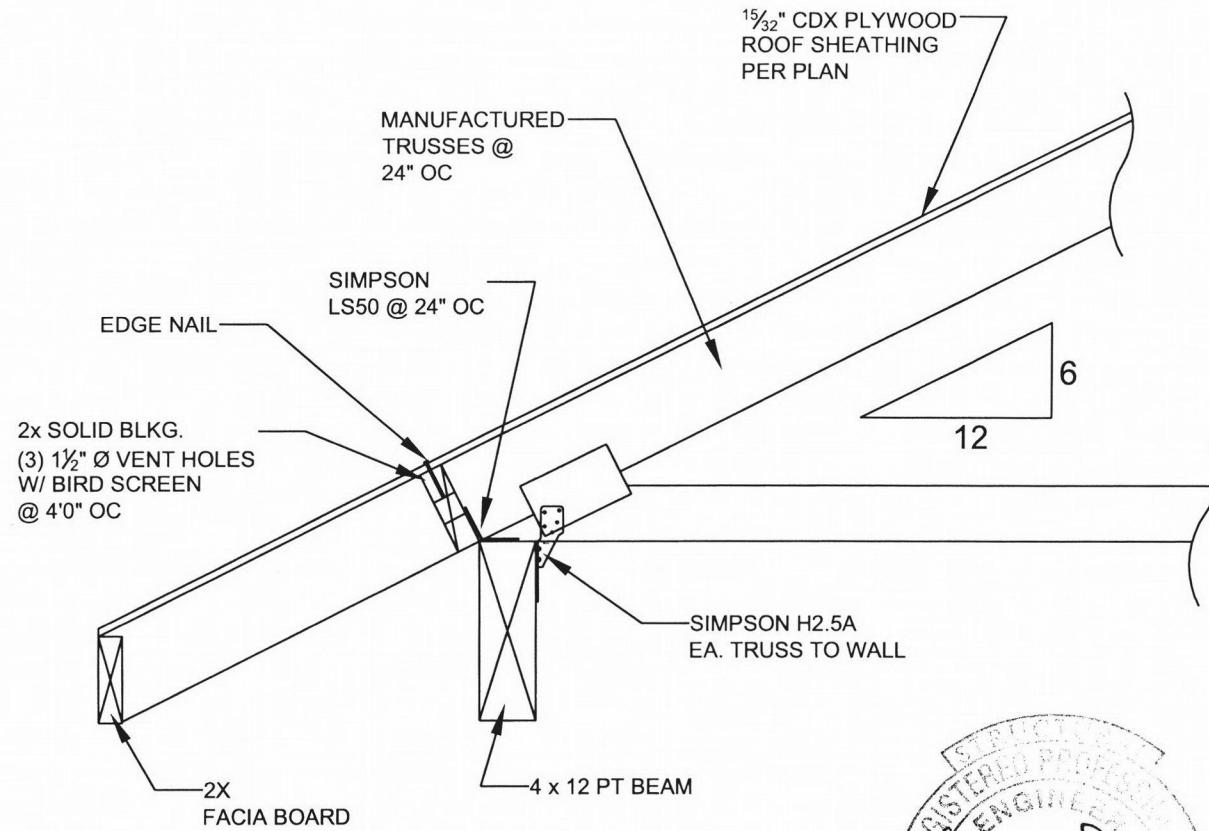

1 5/32" CDX PLYWOOD
ROOF SHEATHING
PER PLAN

MANUFACTURED
TRUSSES @
24" OC

EDGE NAIL

SIMPSON
LS50 @ 24" OC

2x SOLID BLKG.
(3) 1 1/2" Ø VENT HOLES
W/ BIRD SCREEN
@ 4'0" OC

SIMPSON H2.5A
EA. TRUSS TO WALL

2x
FACIA BOARD

4 x 12 PT BEAM

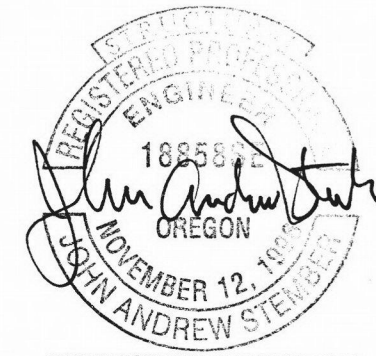

EXPIRES 6-30-2018
6-8-17

1
S-3.2 ROOF TRUSS TO BEAM
1"=1'0"

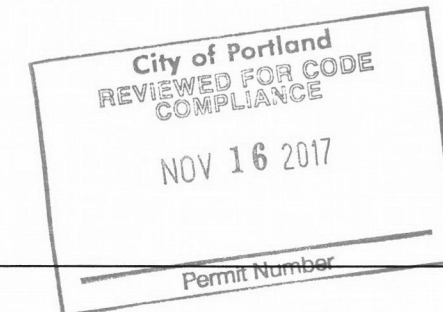

1419 Washington St.
Suite 100
Oregon City, Oregon 97045
Work: 503-657-9800
Cell: 503-449-3080
Andy@jasenginc.com



GABRIEL PARK APART. FIRE RESTORATION
HARBRO
7740 SW 45TH AVE,
PORTLAND, OR 97219

COPYRIGHT 2017 JAS ENGINEERING	DESIGN BY:	JAS
	DRAWN BY:	DAS
	JAS PROJ. NO.:	17-024
	ISSUE DATE:	5/8/2017

SHEET TITLE:
**ROOF
DETAIL**

SHEET NO.:
S-3.2

SCALES NOTED ON DRAWINGS ARE FOR
11"X17" SHEET. SCALE ACCORDINGLY
FOR DIFFERENT SIZE SHEET.

1419 Washington St,
 Suite 100
 Oregon City, Oregon 97045
 Work: 503-657-9800
 Cell: 503-449-3080
 Andy@jasenginc.com



GABRIEL PARK APART. FIRE RESTORATION
 HARBRO
 7740 SW 45TH AVE,
 PORTLAND, OR 97219

COPYRIGHT 2017 JAS ENGINEERING	DESIGN BY:	JAS
	DRAWN BY:	DA5
	JAS PROJ. NO.:	17-024
	ISSUE DATE:	5/8/2017
	REGISTERED PROFESSIONAL ENGINEER	188588

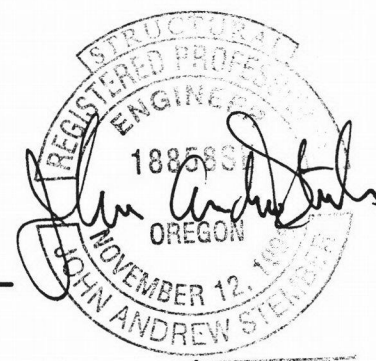

EXPIRES: 6-30-2018
 6-8-17

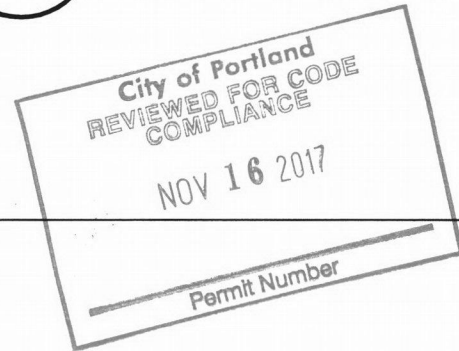

SHEET TITLE:	
ROOF DETAIL	
SHEET NO.:	
S-3.3	

SCALES NOTED ON DRAWINGS ARE FOR 11"x17" SHEET. SCALE ACCORDINGLY FOR DIFFERENT SIZE SHEET.

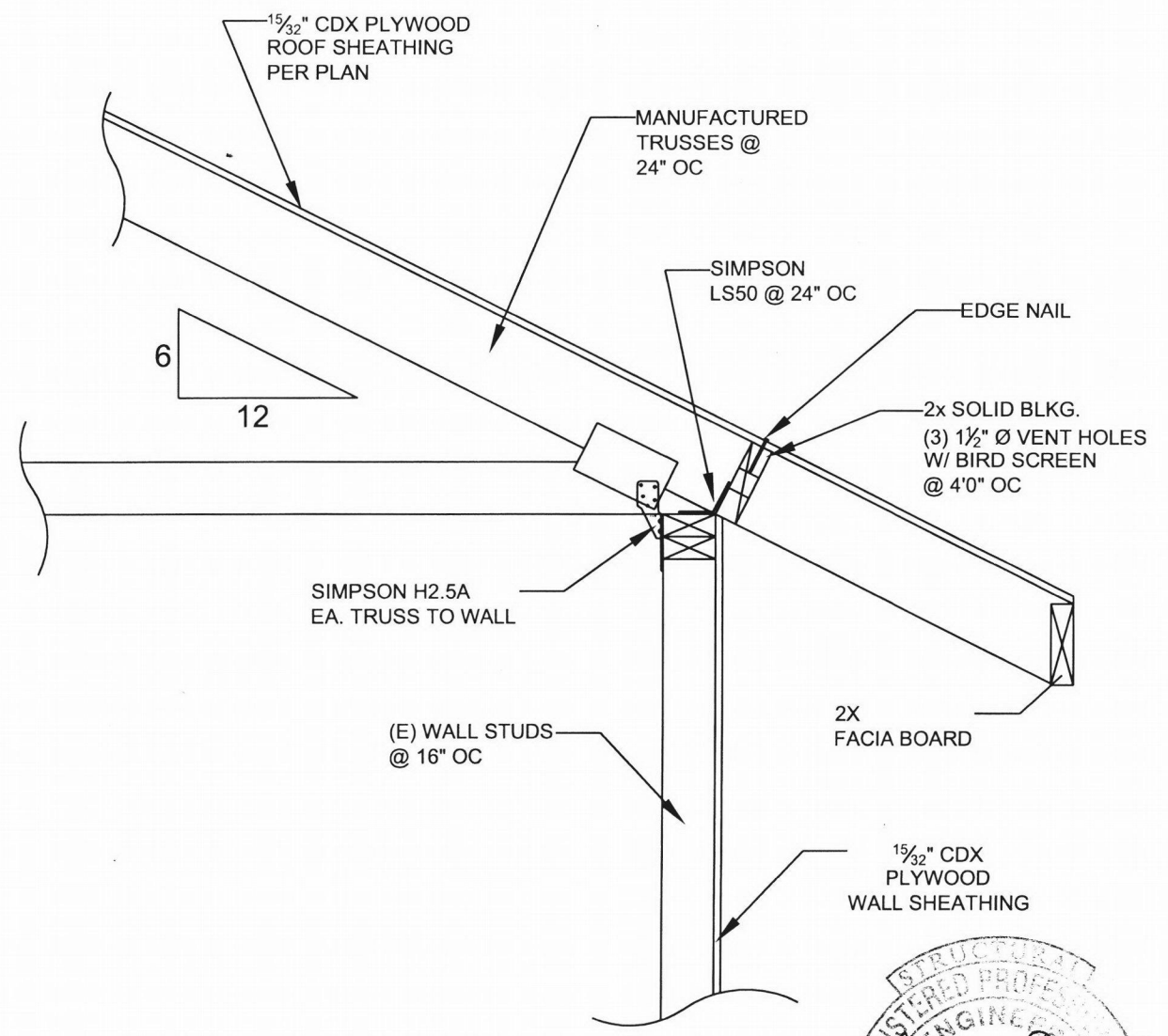

1 ROOF TRUSS TO WALL
 S-3.3 1"=1'0"

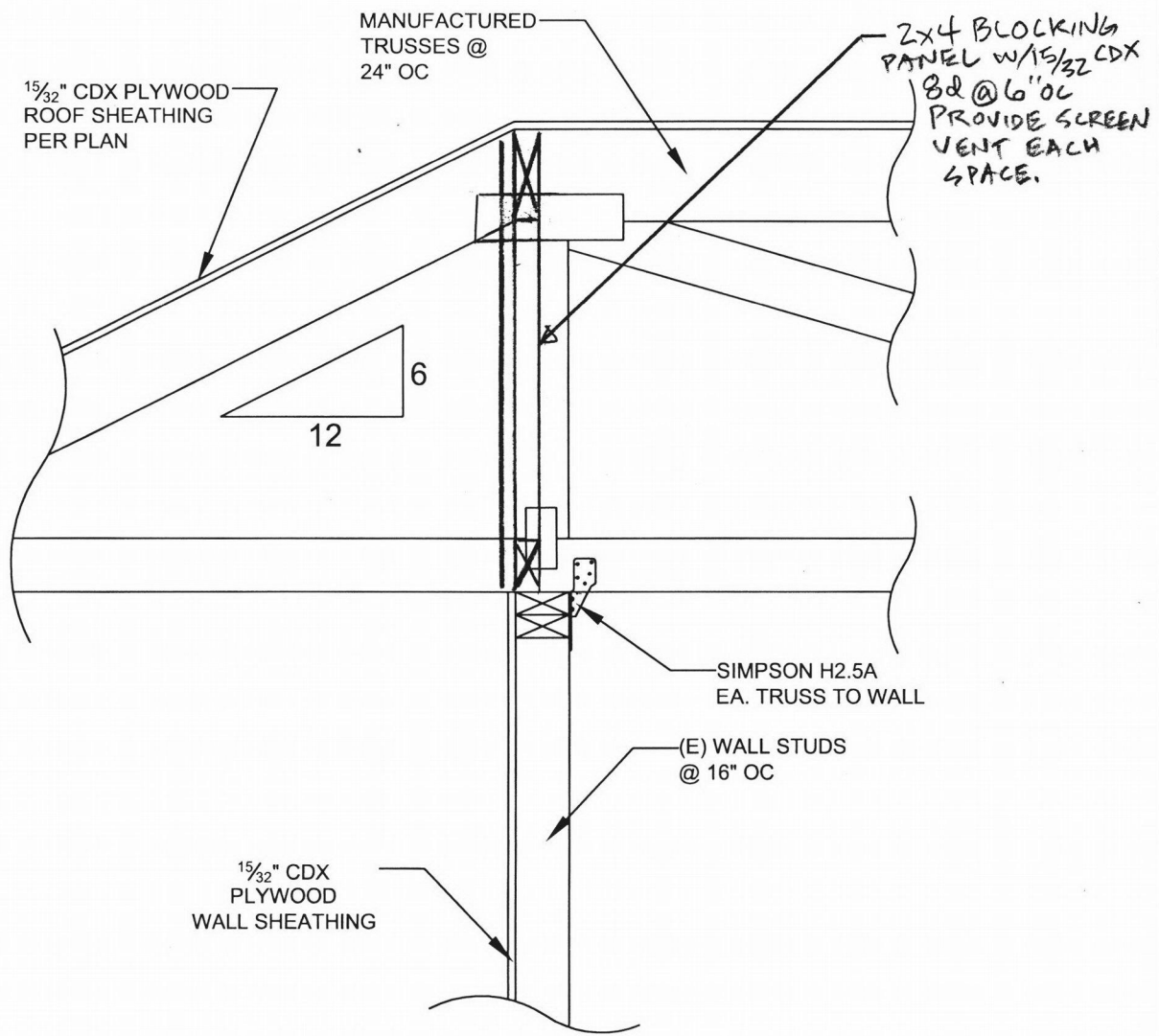

2 ROOF TRUSS TO REAR WALL
 S-3.3 1"=1'0"

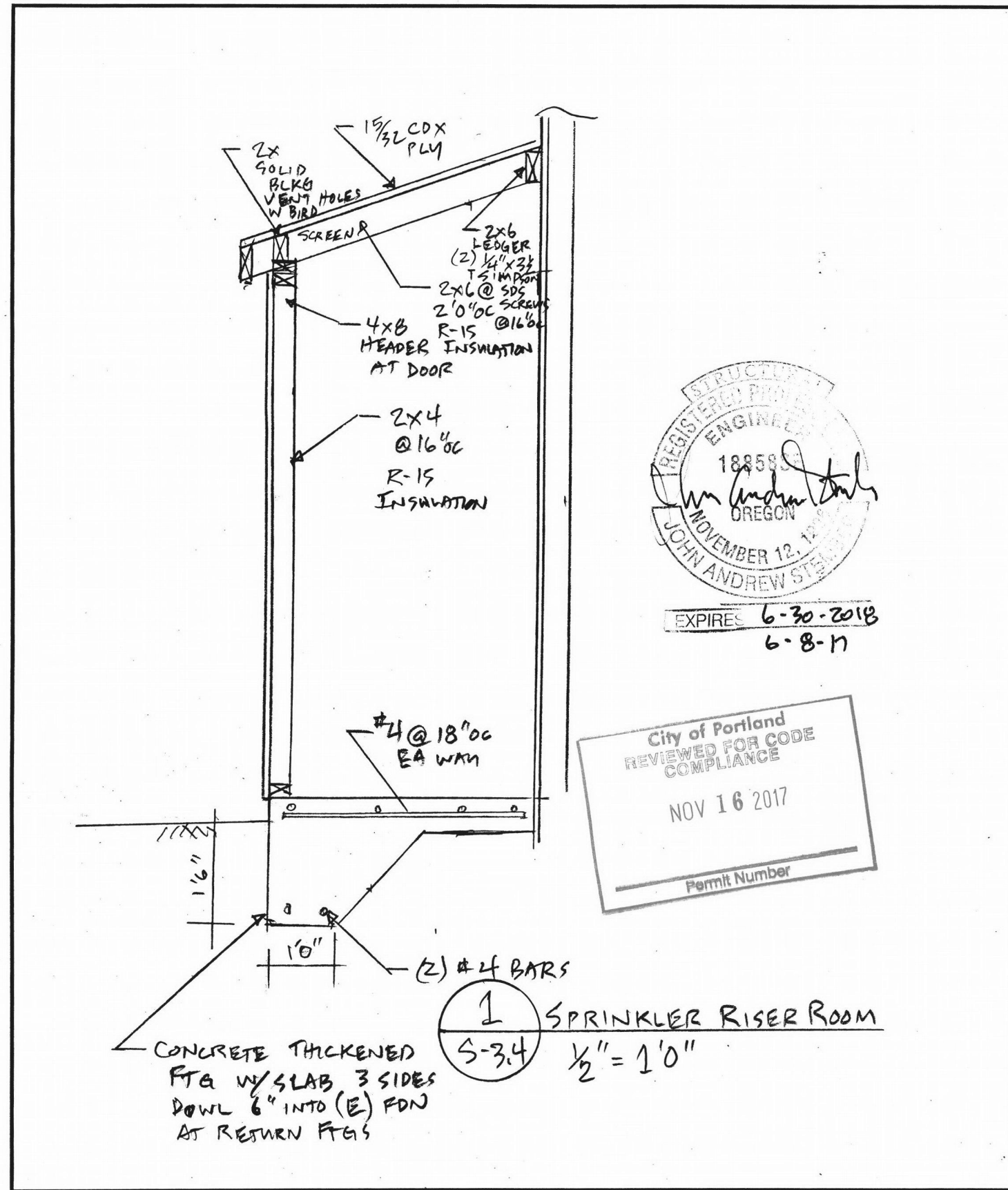

1419 Washington St.
 Suite 100
 Oregon City, Oregon 97045
 Work: 503-657-9800
 Cell: 503-449-3080
 Andy@jasenginc.com



GABRIEL PARK APART. FIRE RESTORATION
 HARBRO
 7740 SW 45TH AVE,
 PORTLAND, OR 97219

COPYRIGHT 2017 JAS ENGINEERING	DESIGN BY: JAS	DRAWN BY: DAS	JAS PROJ. NO.: 17-024	ISSUE DATE: 5/8/2017
-----------------------------------	-------------------	------------------	--------------------------	-------------------------

SHEET TITLE:
 SPRINKLER
 RISER ROOM

SHEET NO.:
 5-3.4

SCALES NOTED ON DRAWINGS ARE FOR 11"X17" SHEET. SCALE ACCORDINGLY FOR DIFFERENT SIZE SHEET.

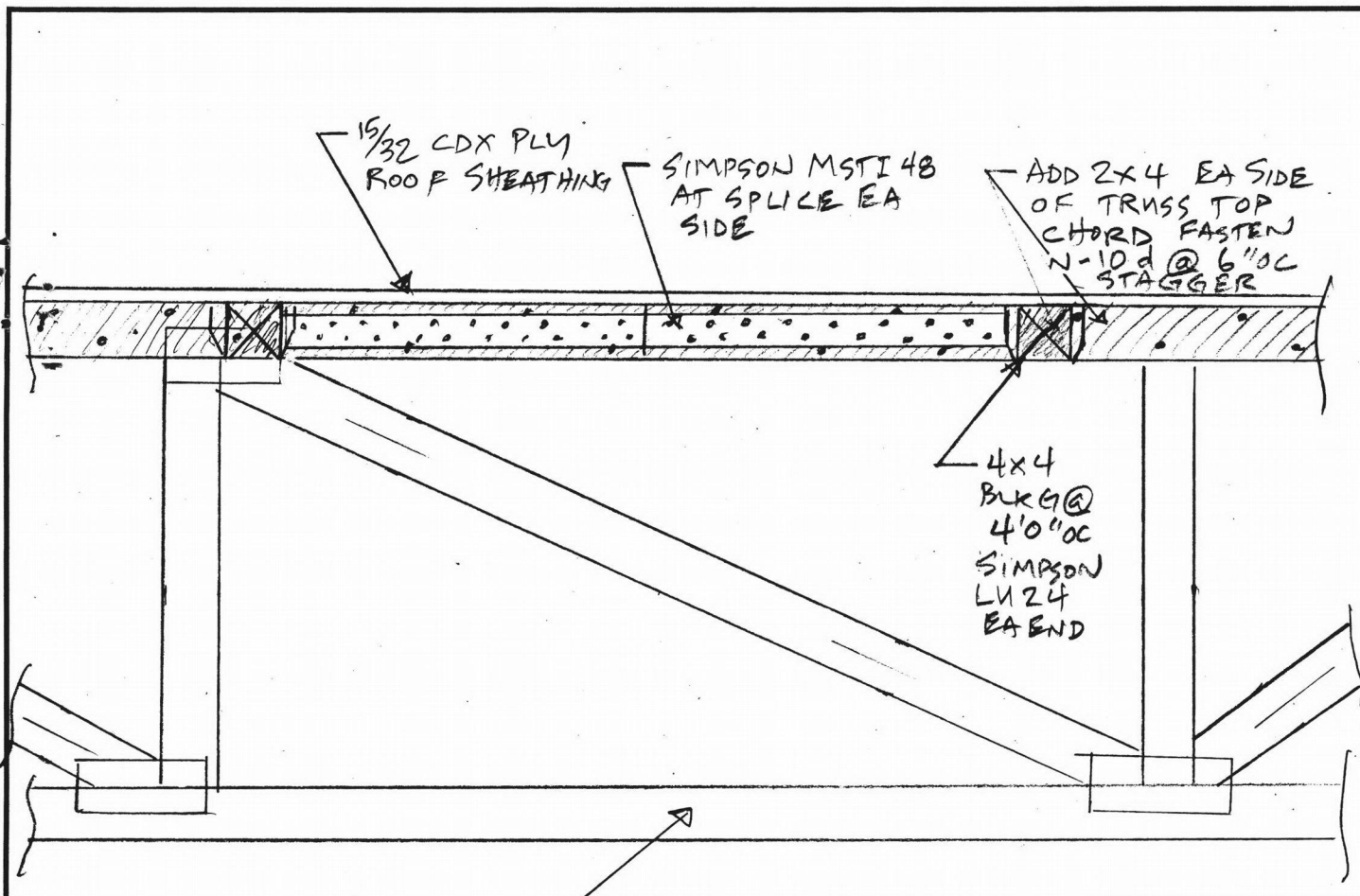

2 DIAPHRAGM CHORD DETAIL
S-3.5 1" = 1'0"

City of Portland
REVIEWED FOR CODE COMPLIANCE
NOV 16 2017
Permit Number

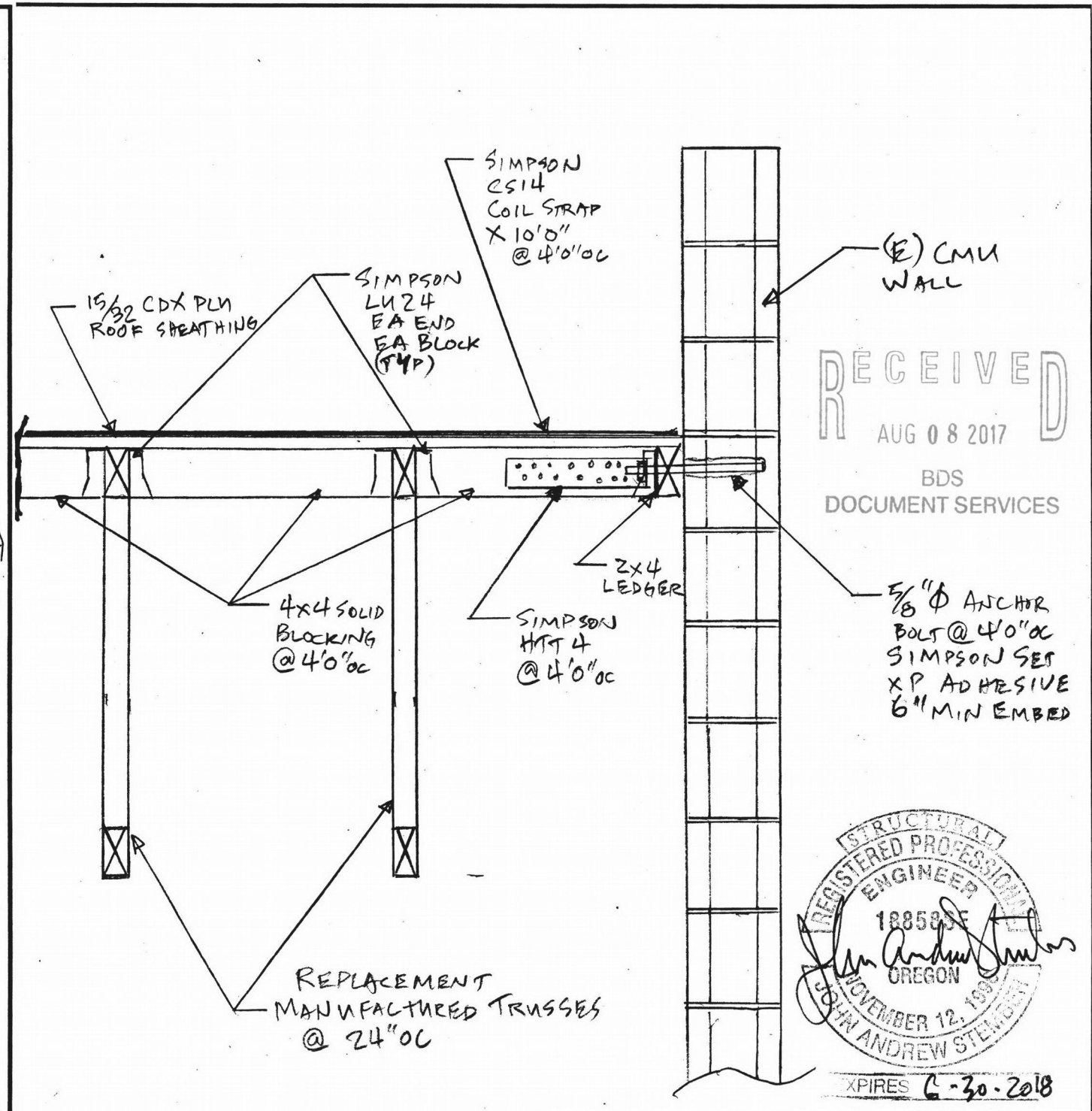

1 CMU WALL SUPPORT
S-3.5 1" = 1'0"

SCALES NOTED ON DRAWINGS ARE FOR 11"x17" SHEET. SCALE ACCORDINGLY FOR DIFFERENT SIZE SHEET.

1419 Washington St.
Suite 100
Oregon City, Oregon 97045
Work: 503-657-9800
Cell: 503-449-3080
Andy@jasenginc.com



GABRIEL PARK APART. FIRE RESTORATION
HARBRO
7740 SW 45TH AVE,
PORTLAND, OR 97219

COPYRIGHT 2017 JAS ENGINEERING	JAS	DAS	17-024	5/8/2017
DESIGN BY:	JAS	DAS		
DRAWN BY:				
JAS PROJ. NO.:				
ISSUE DATE:				

SHEET TITLE:
CMU WALL SUPPORT DETAILS

SHEET NO.:
S-3.5