

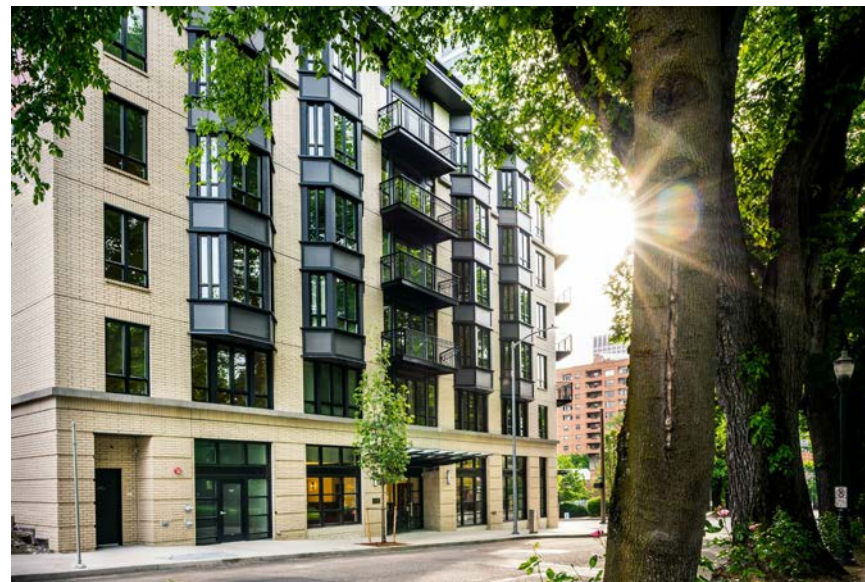

EXISTING TIFFANY AND CLAY APARTMENTS



11 MARCHE APARTMENTS



CAMERON APARTMENTS

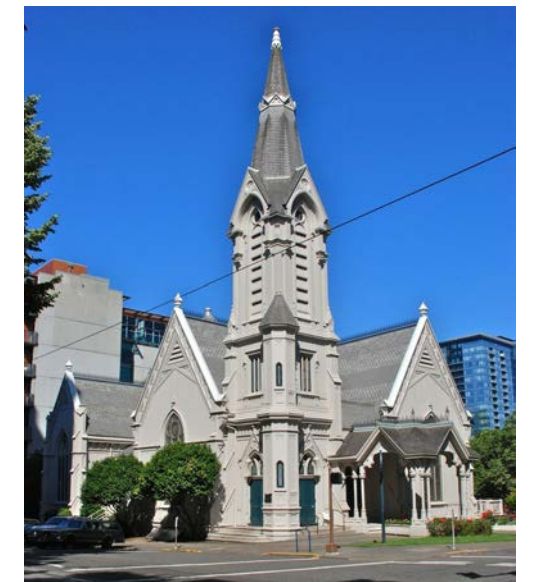

INTOWN PRESBYTERIAN CHURCH



BENSON TOWER



MUSEUM PLACE APARTMENTS



SKY 3 APARTMENTS



THE JEFFREY APARTMENTS



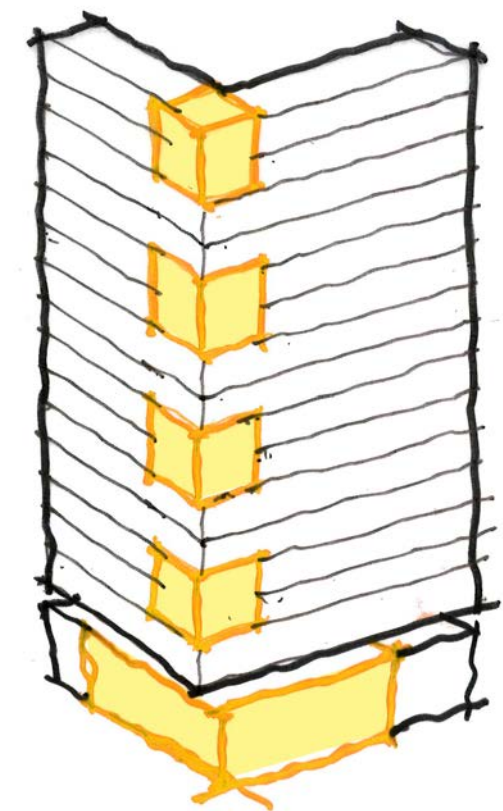
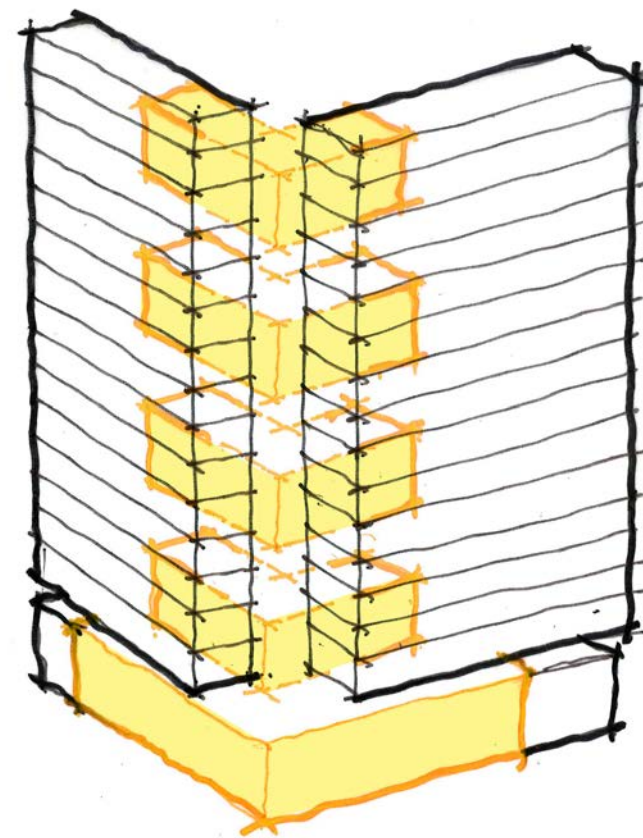
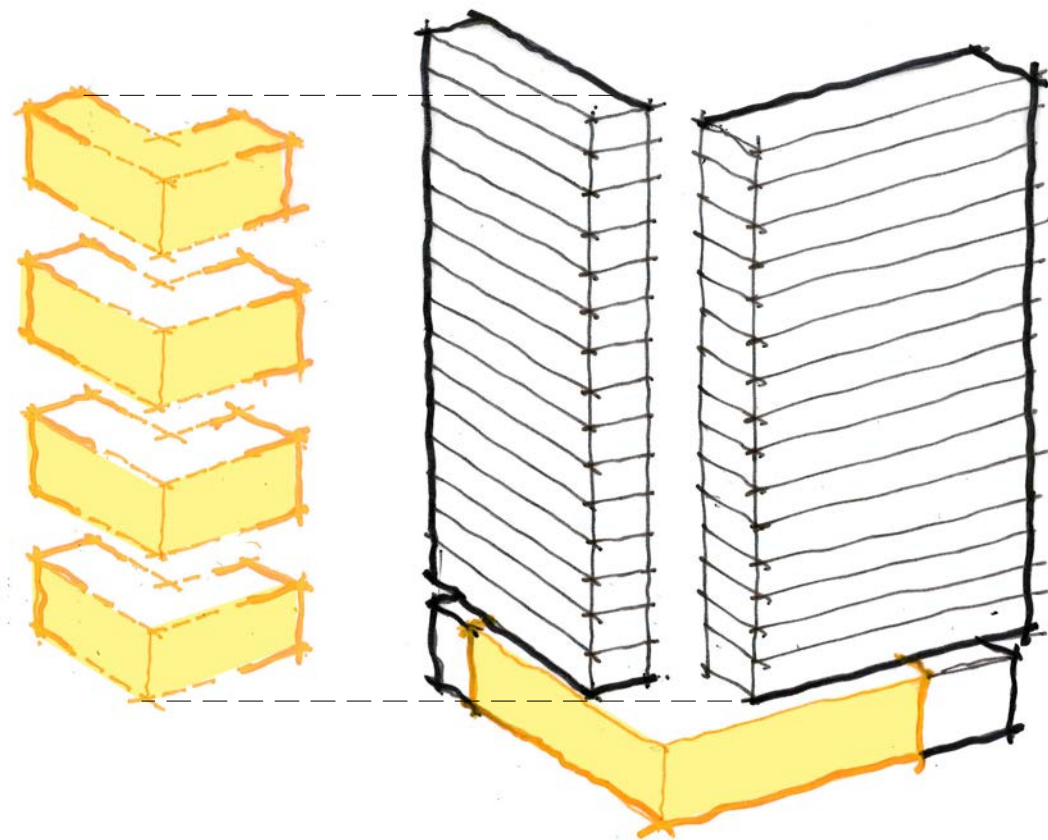

EXPRESS BLDG. PROGRAM

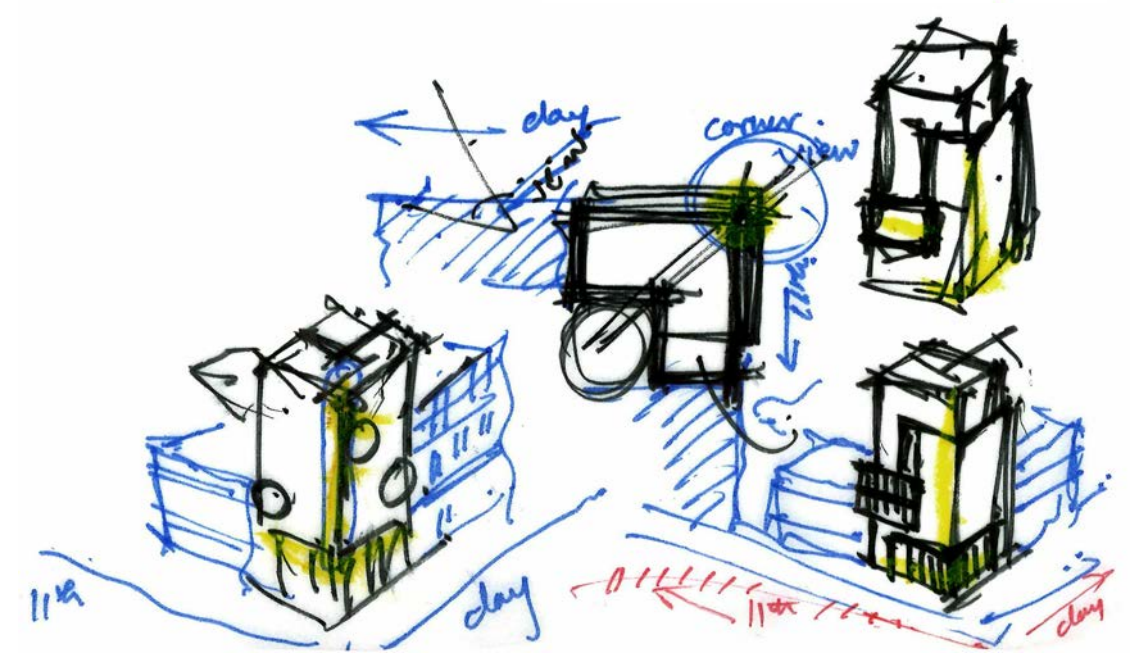
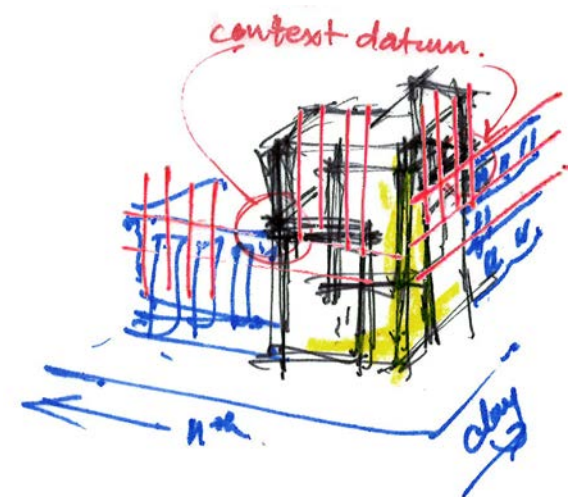
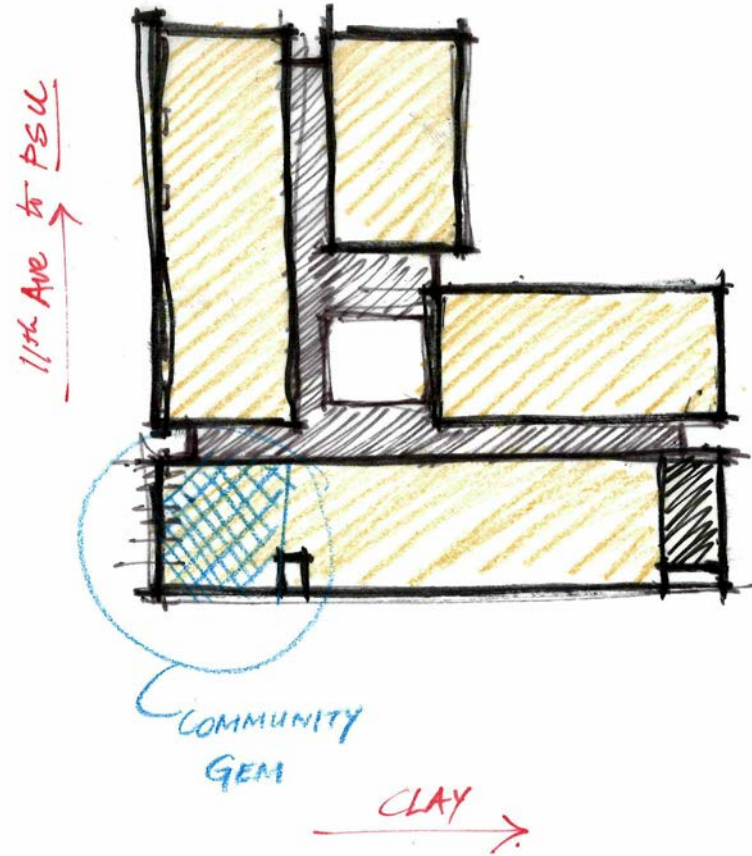
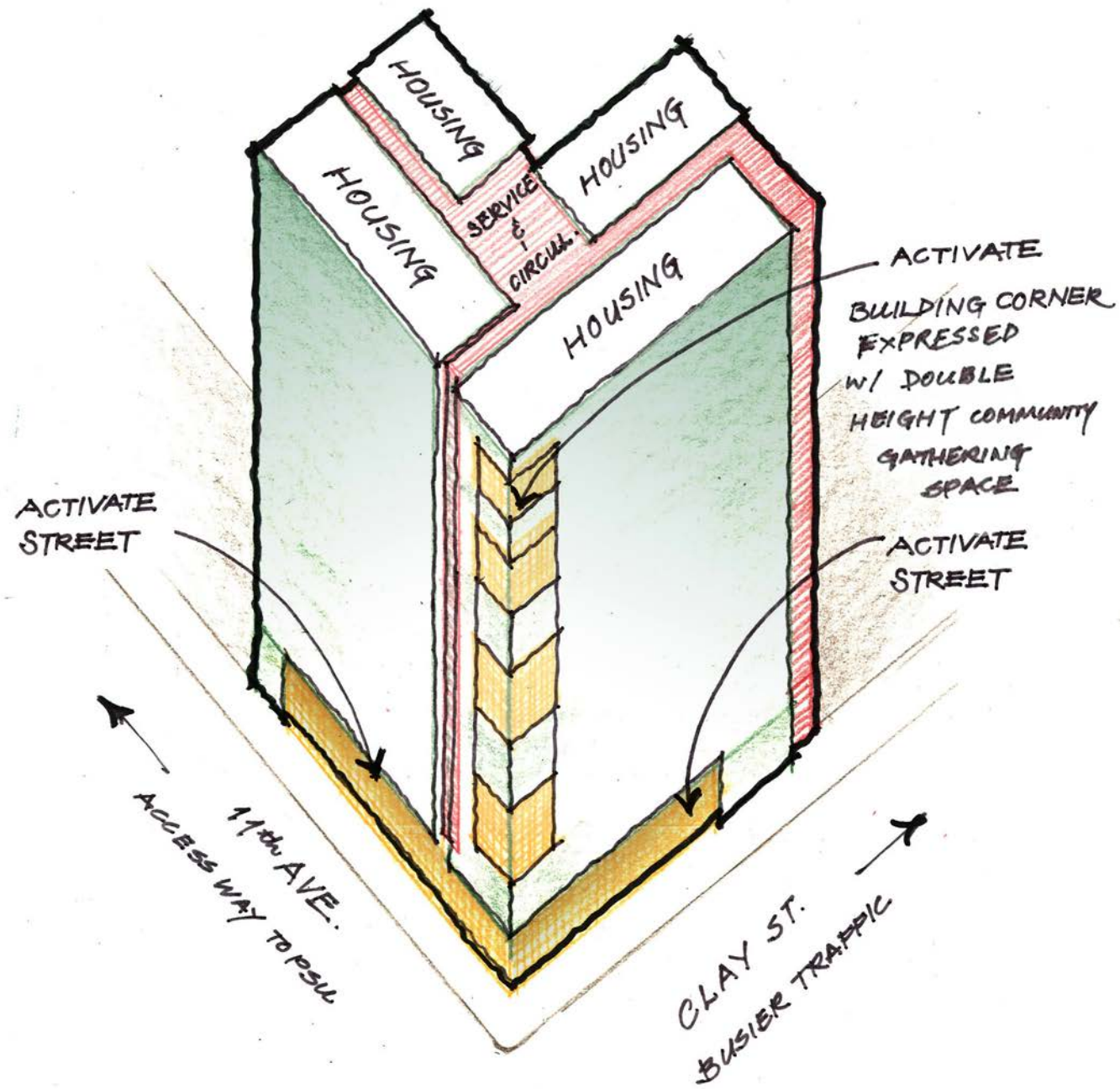

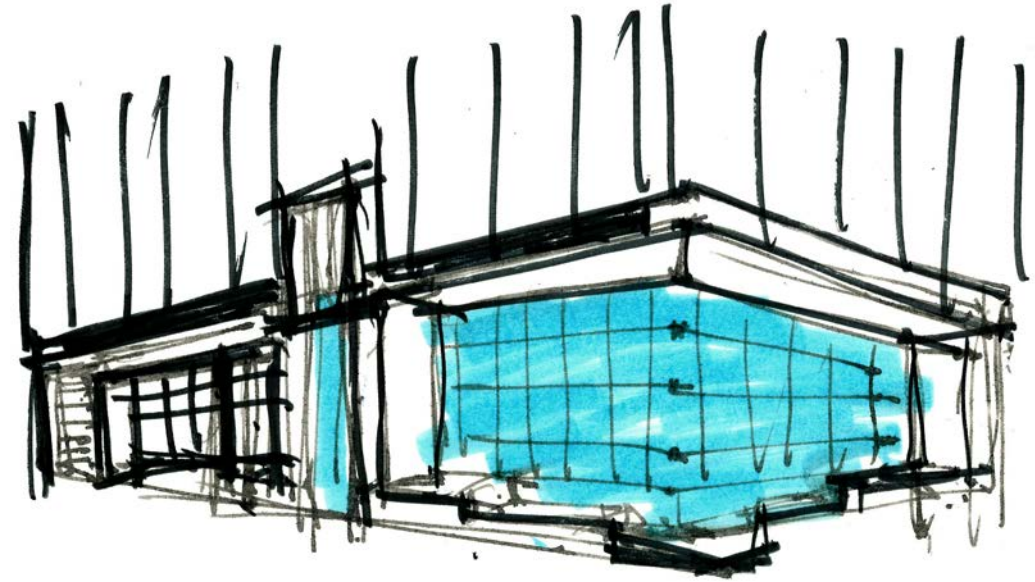

STREET LEVEL ACTIVATION ALONG SW 11TH AVENUE

STREET LEVEL ACTIVATION AT INTERSECTION OF CLAY AND SW 11TH

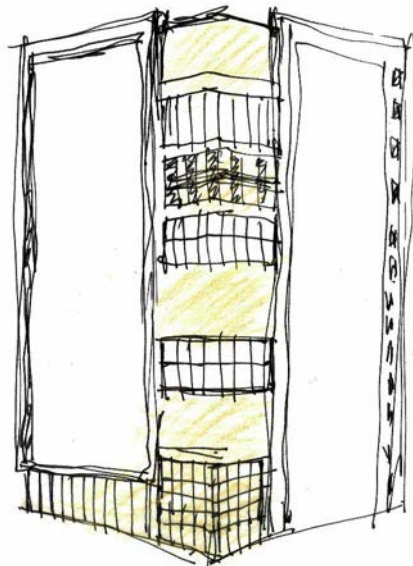

THIN SHELL AT THE UNITS,
EXTENDING CORNER
TO LEVEL 2.

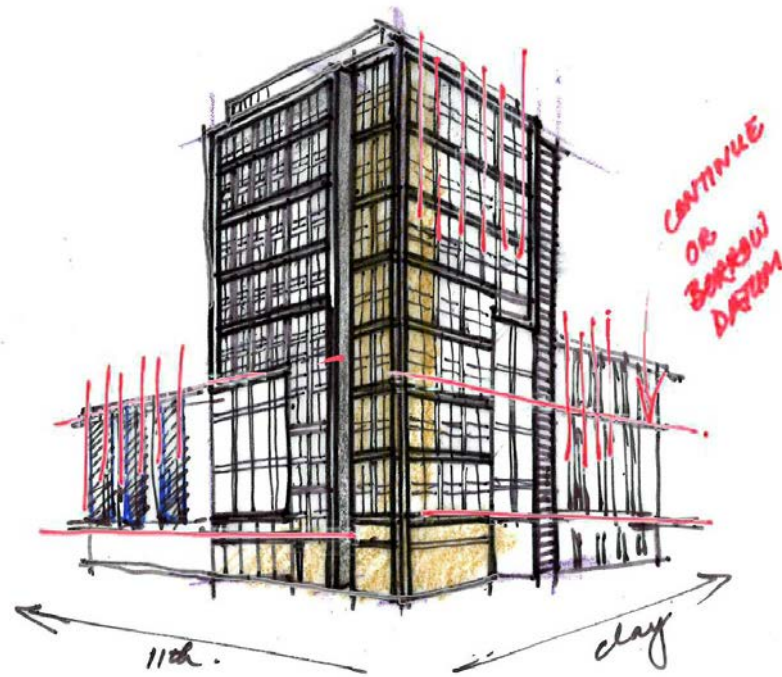

CANTILEVER
OR
BORROW
DATA

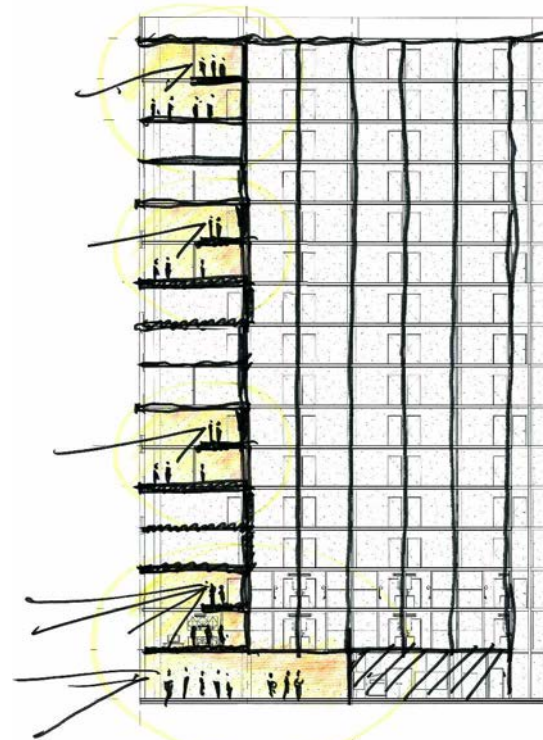

GEM: COMMUNITY
GATHERING SPACE

Stack
the two
reading/
community
room +
open in
floors.

1BR

1BR

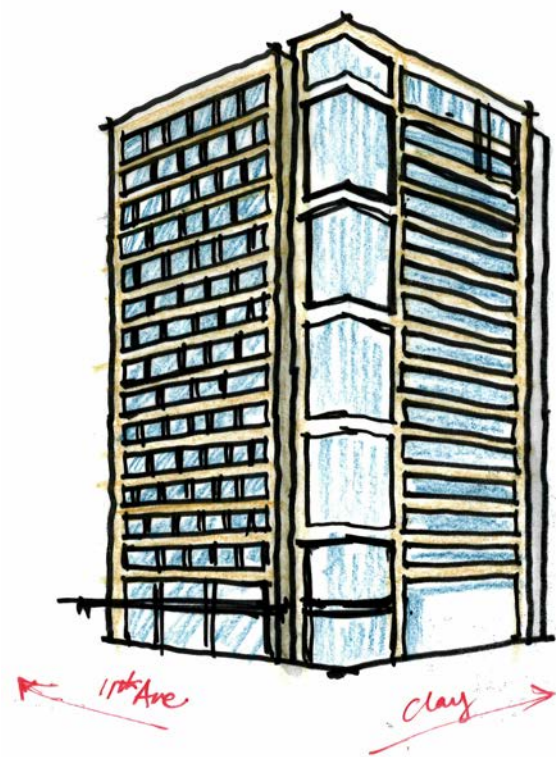
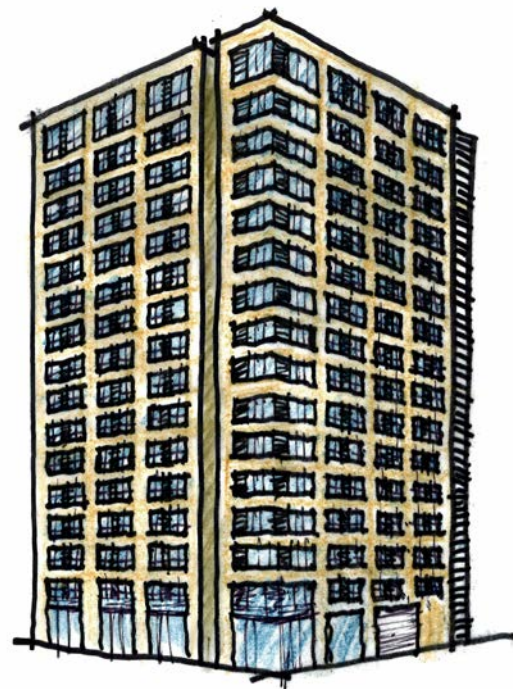

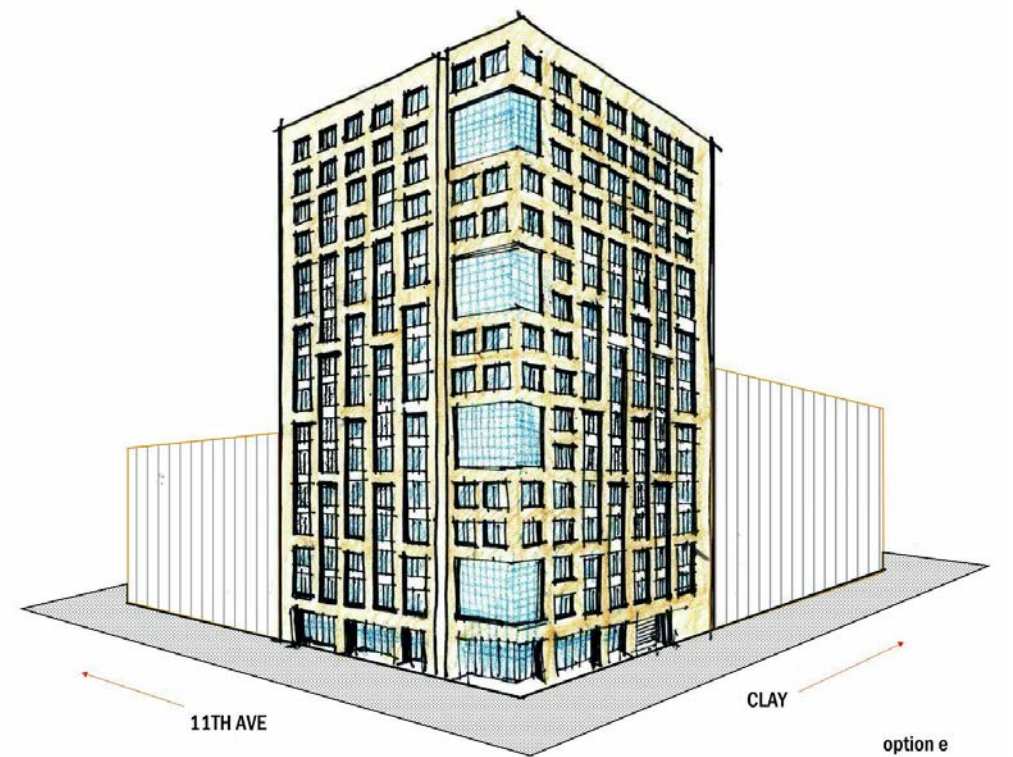
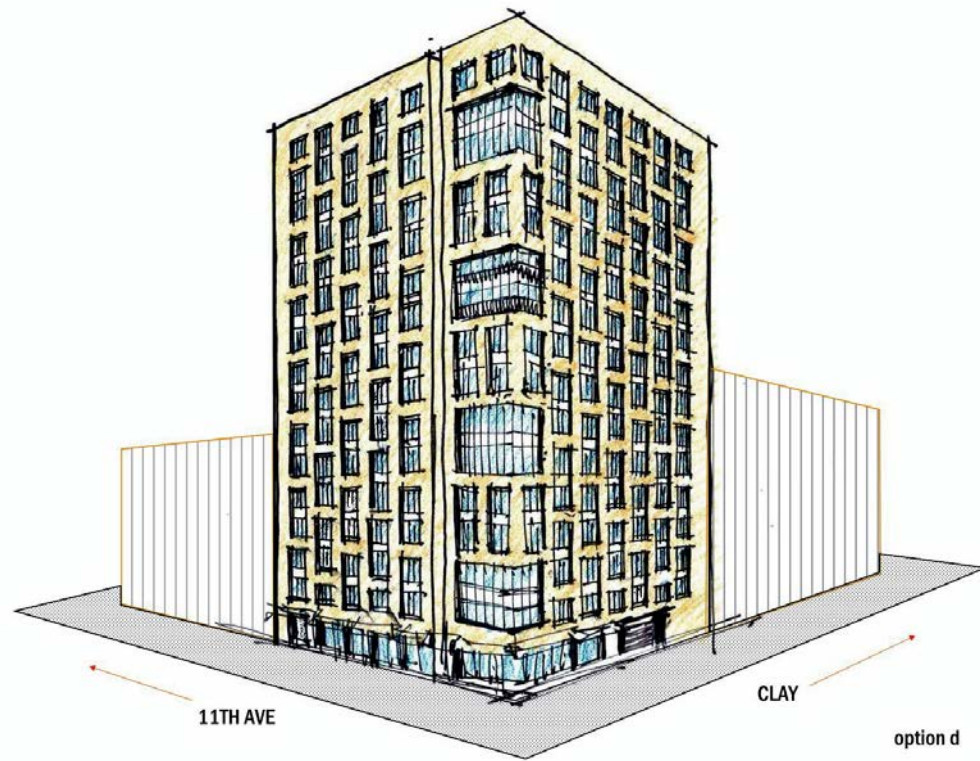
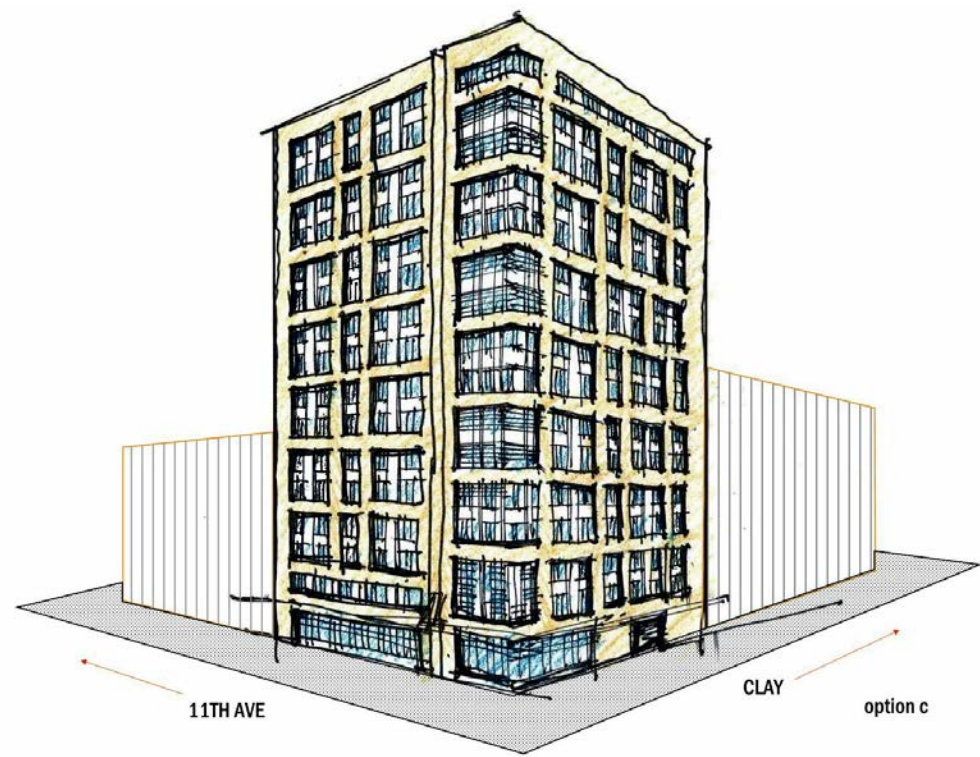

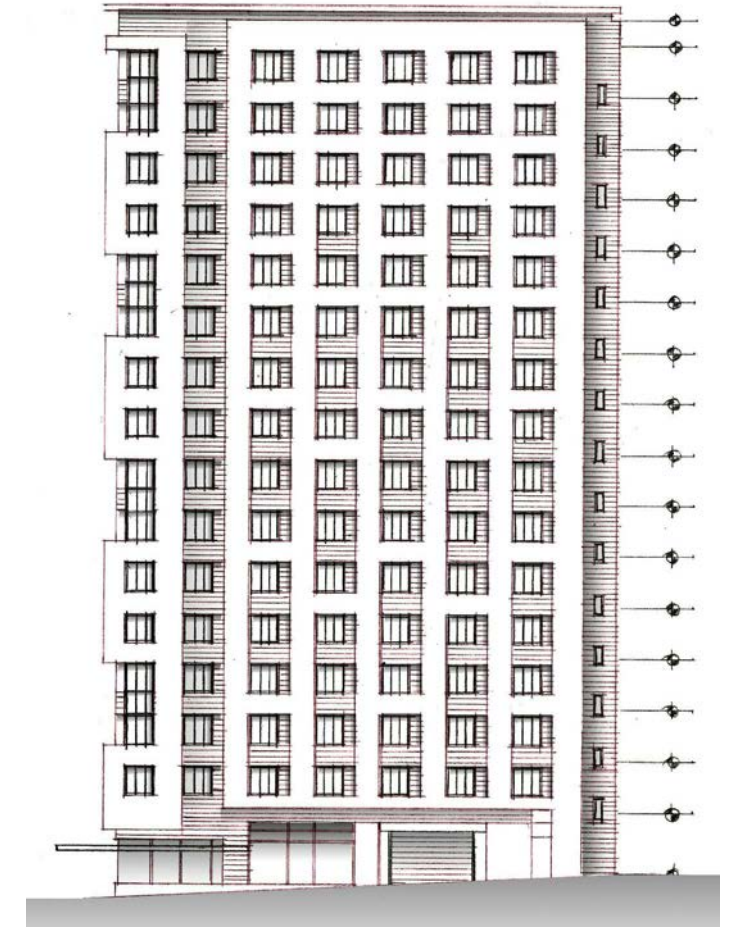
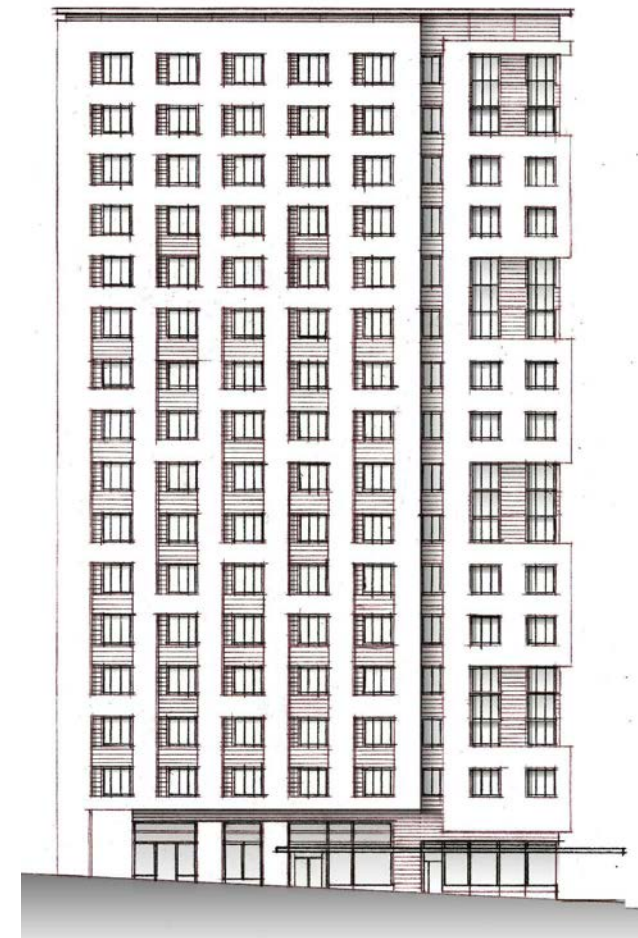
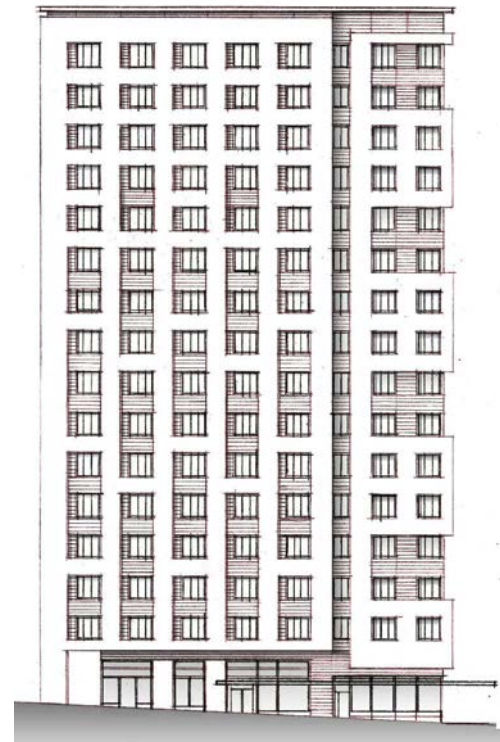













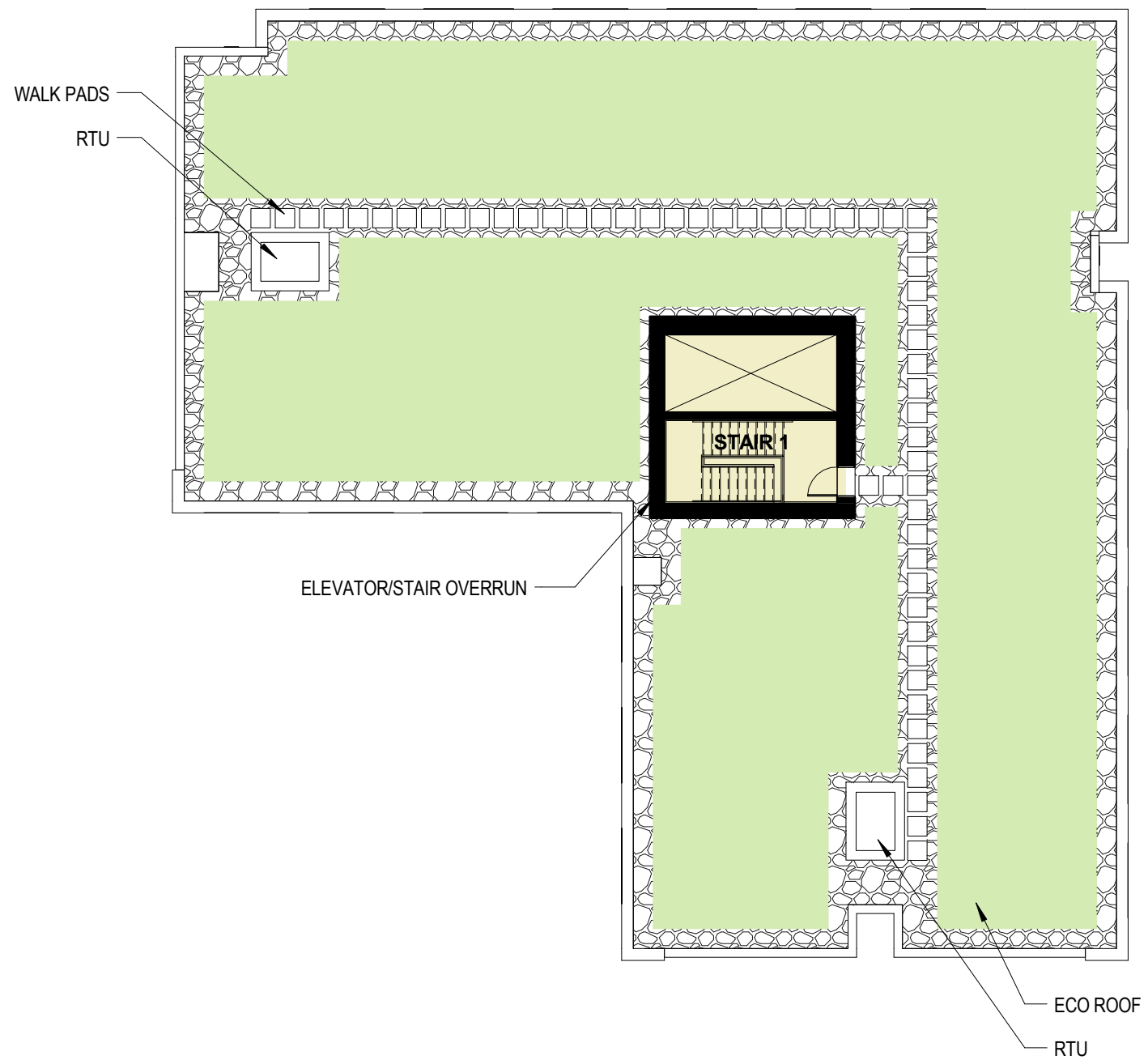

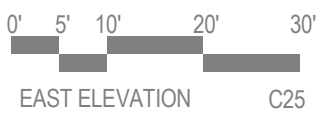
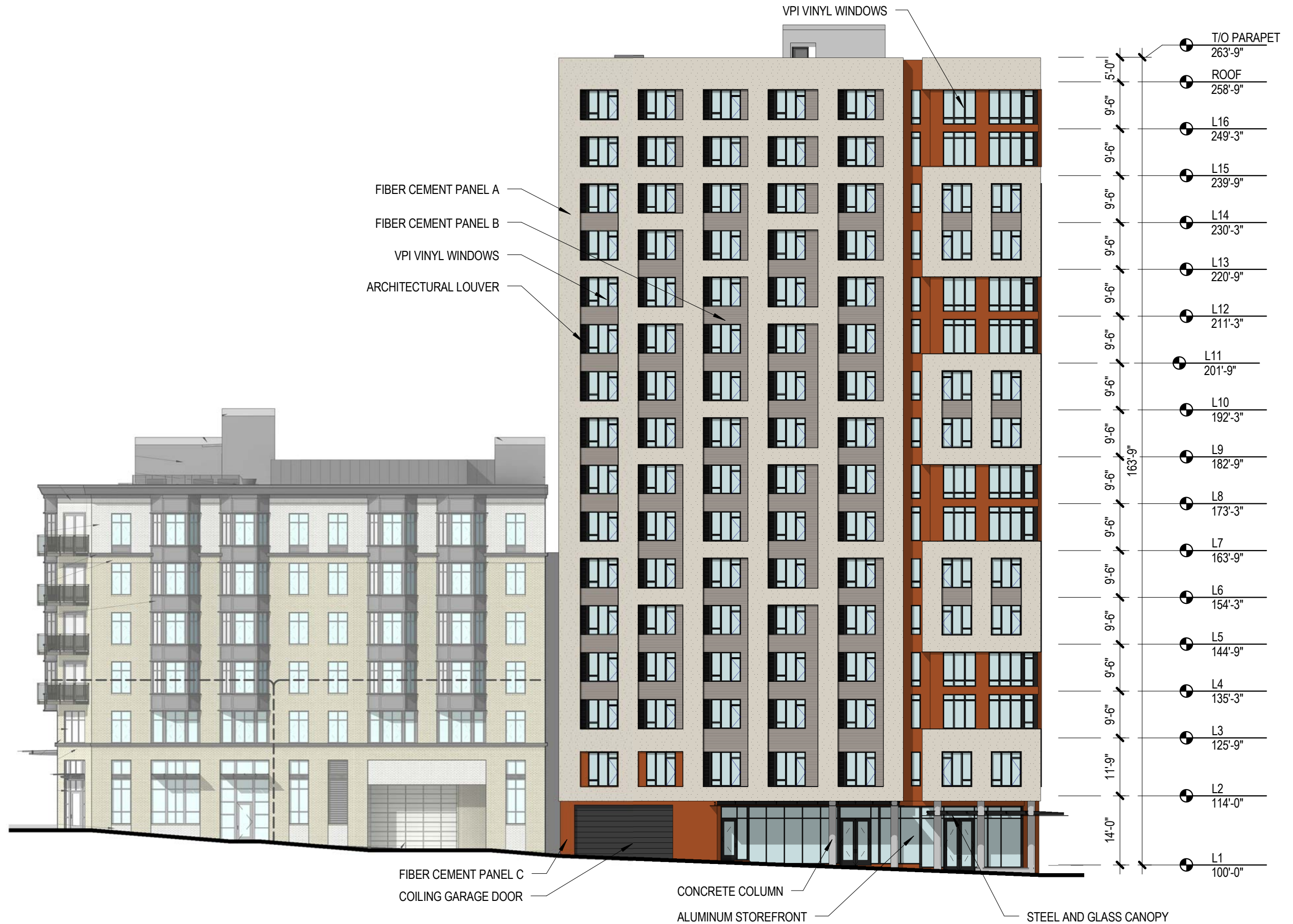



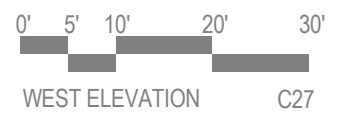
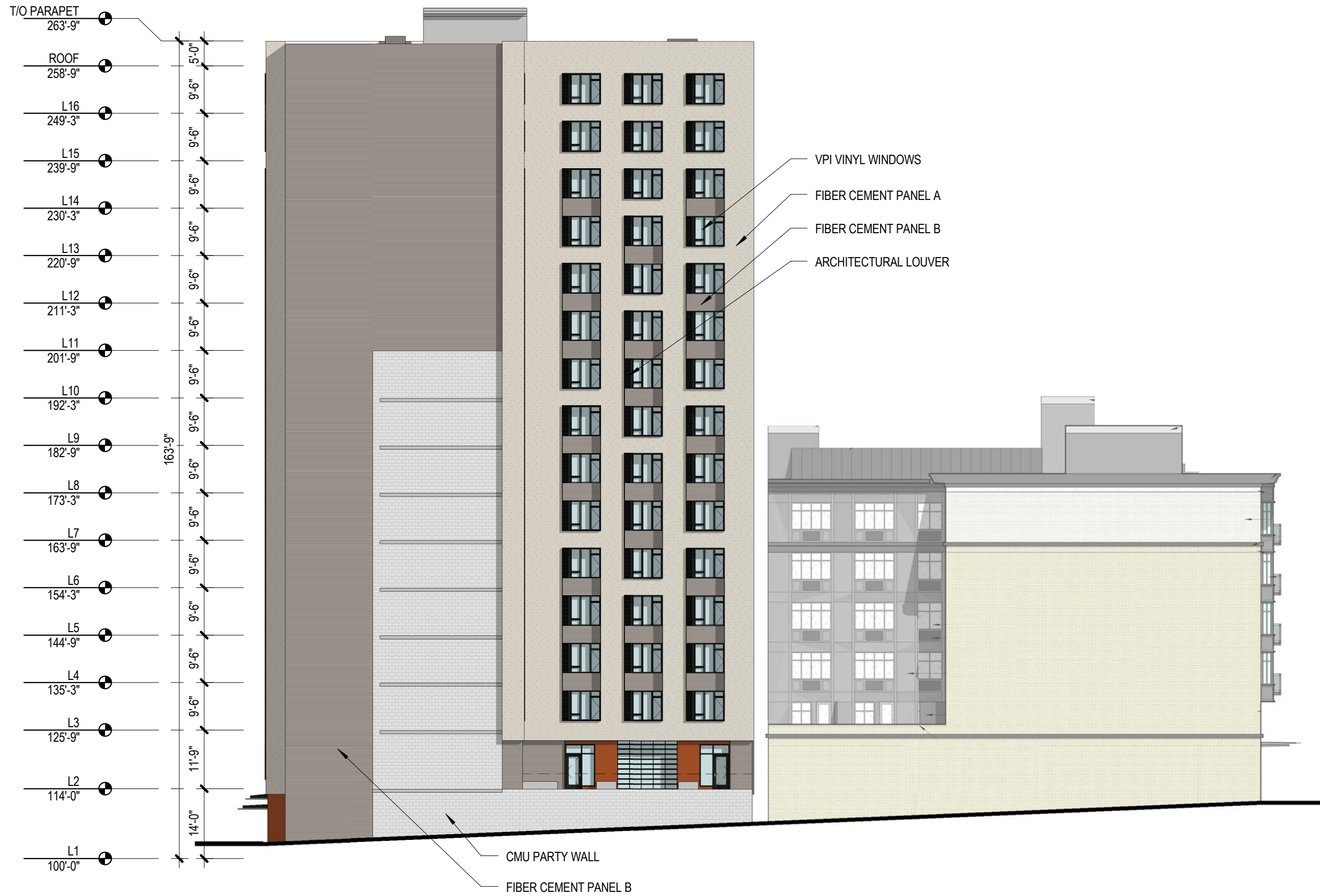

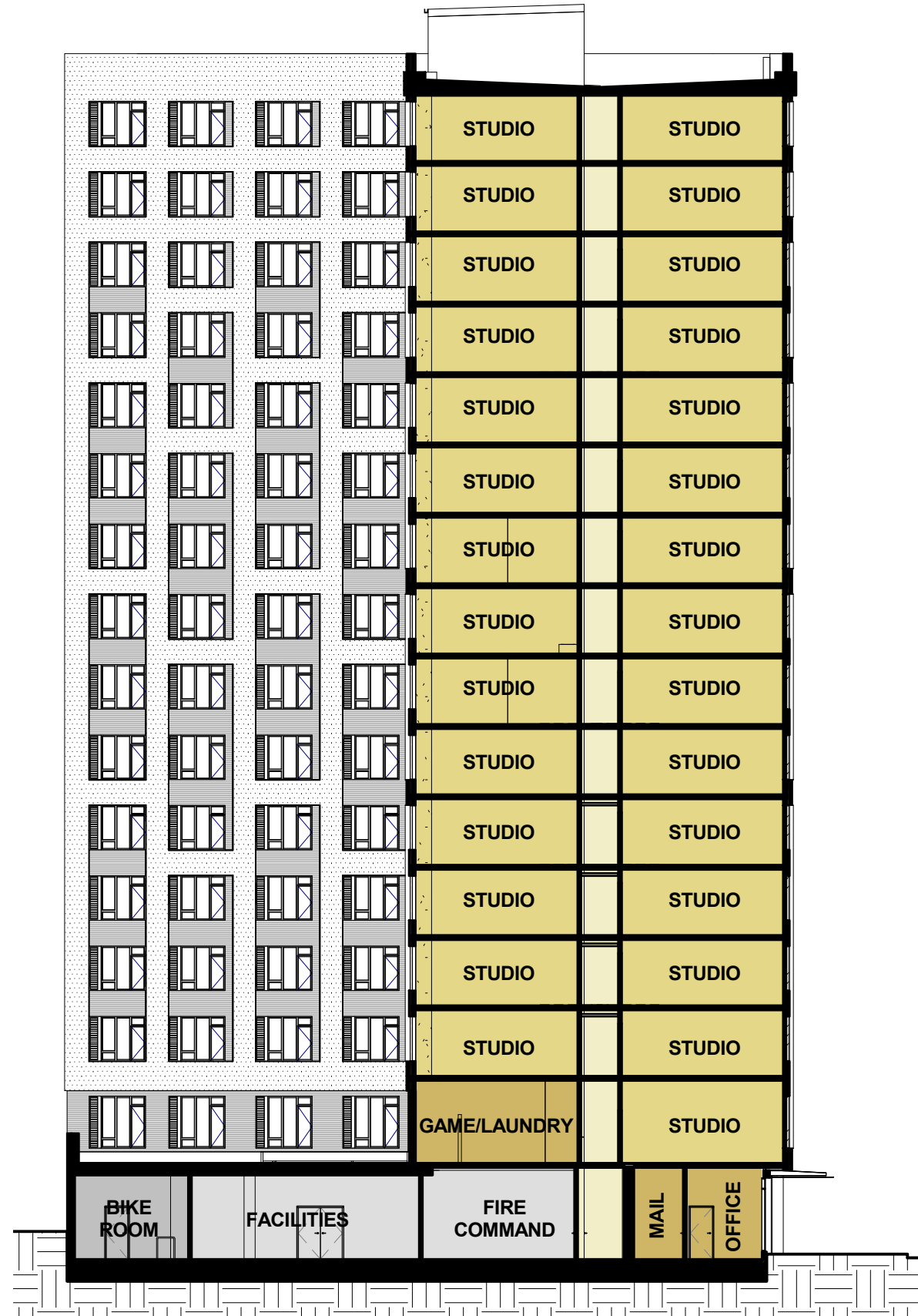

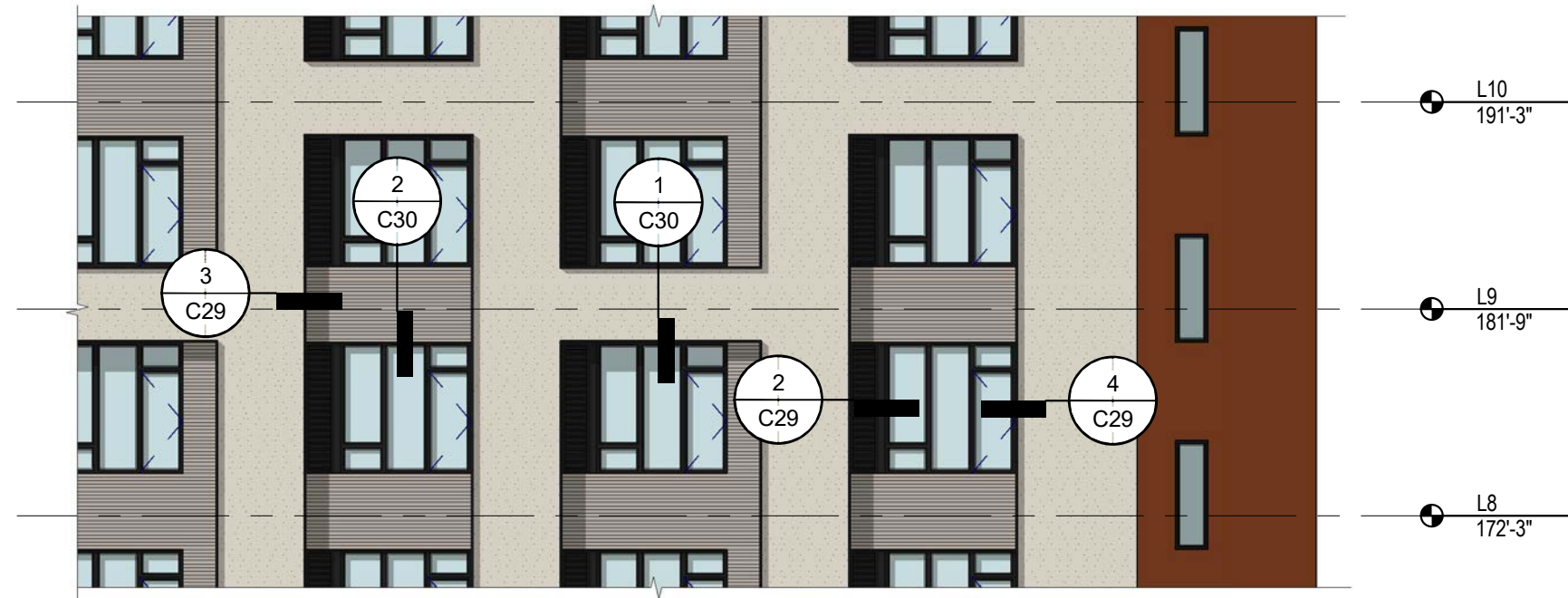

1 ENLARGED ELEVATION - NORTH

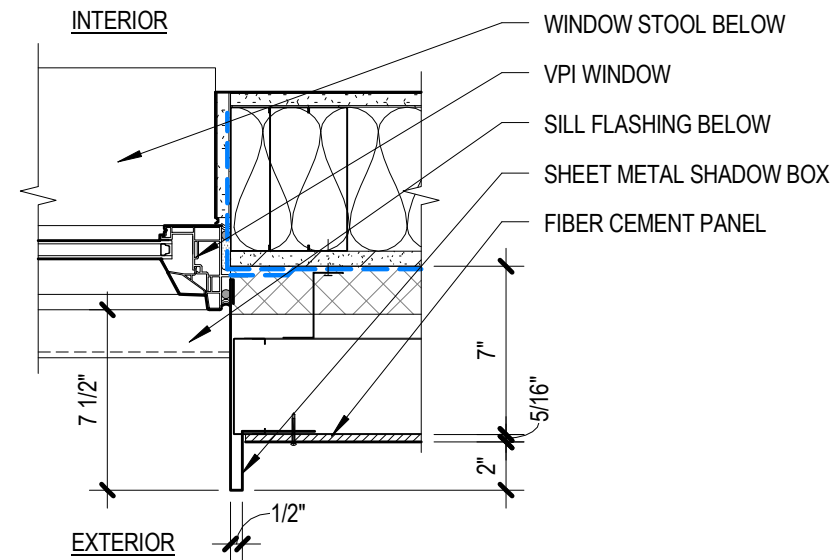

4 WINDOW JAMB, TYP.

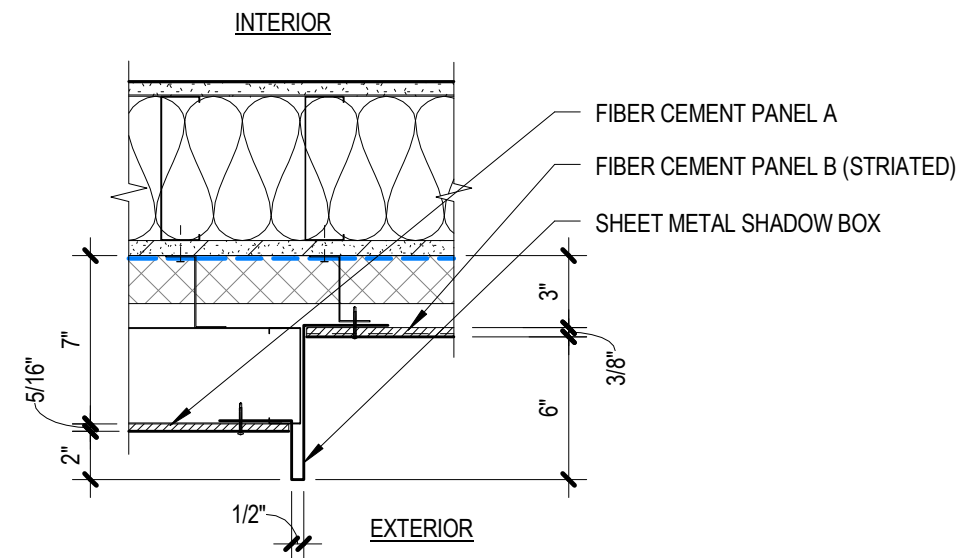

3 FIBER CEMENT TRANSITION

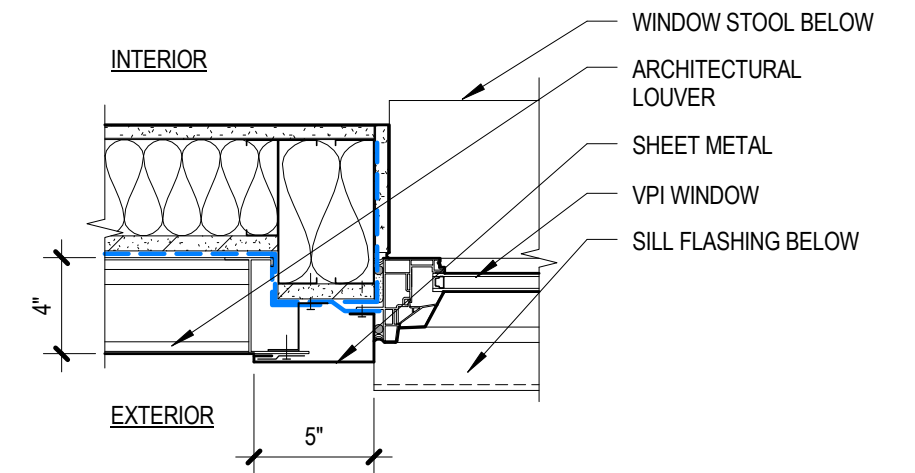

2 WINDOW JAMB @ LOUVER

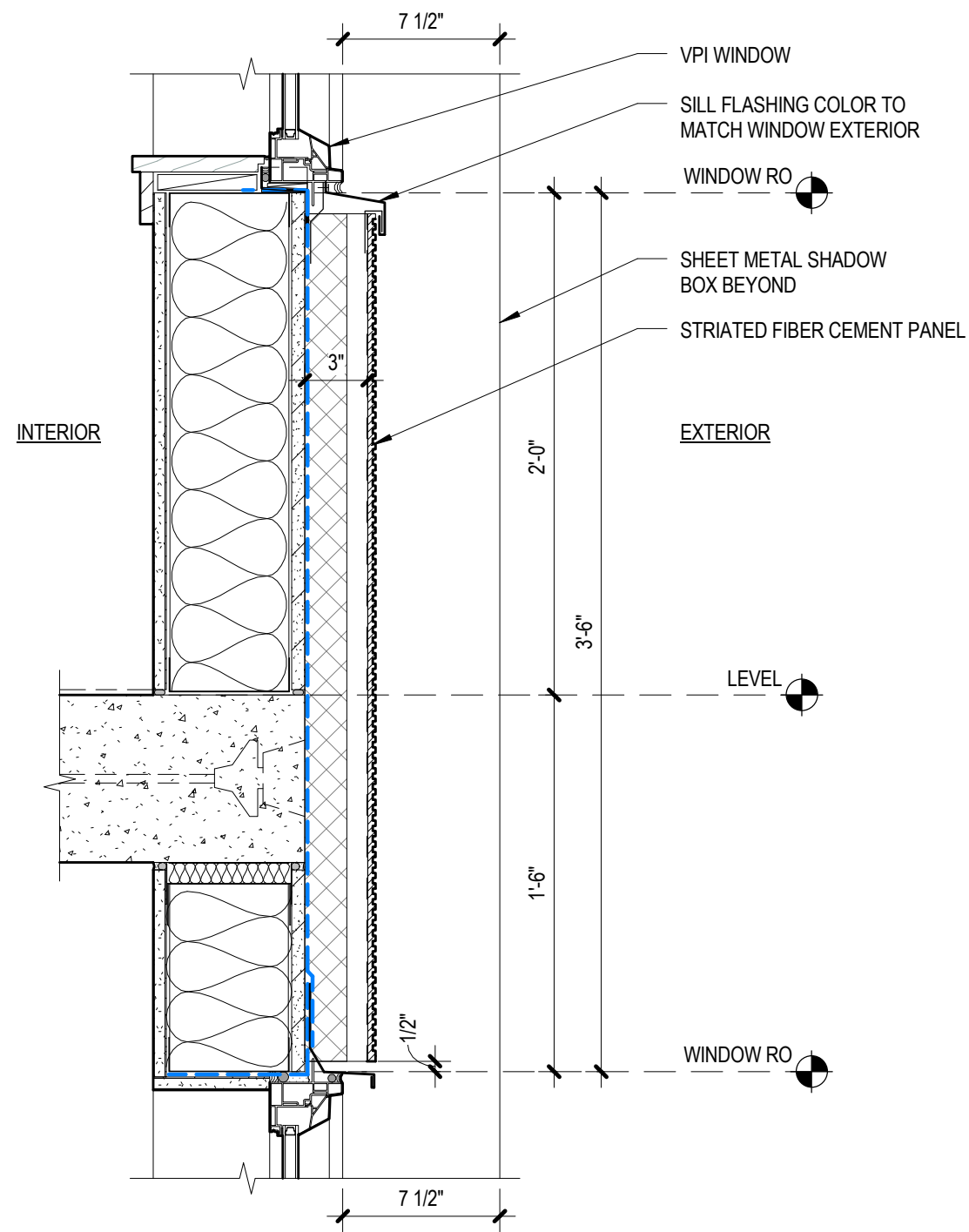

2 WINDOW HEAD/SILL @ SHALLOW WALL

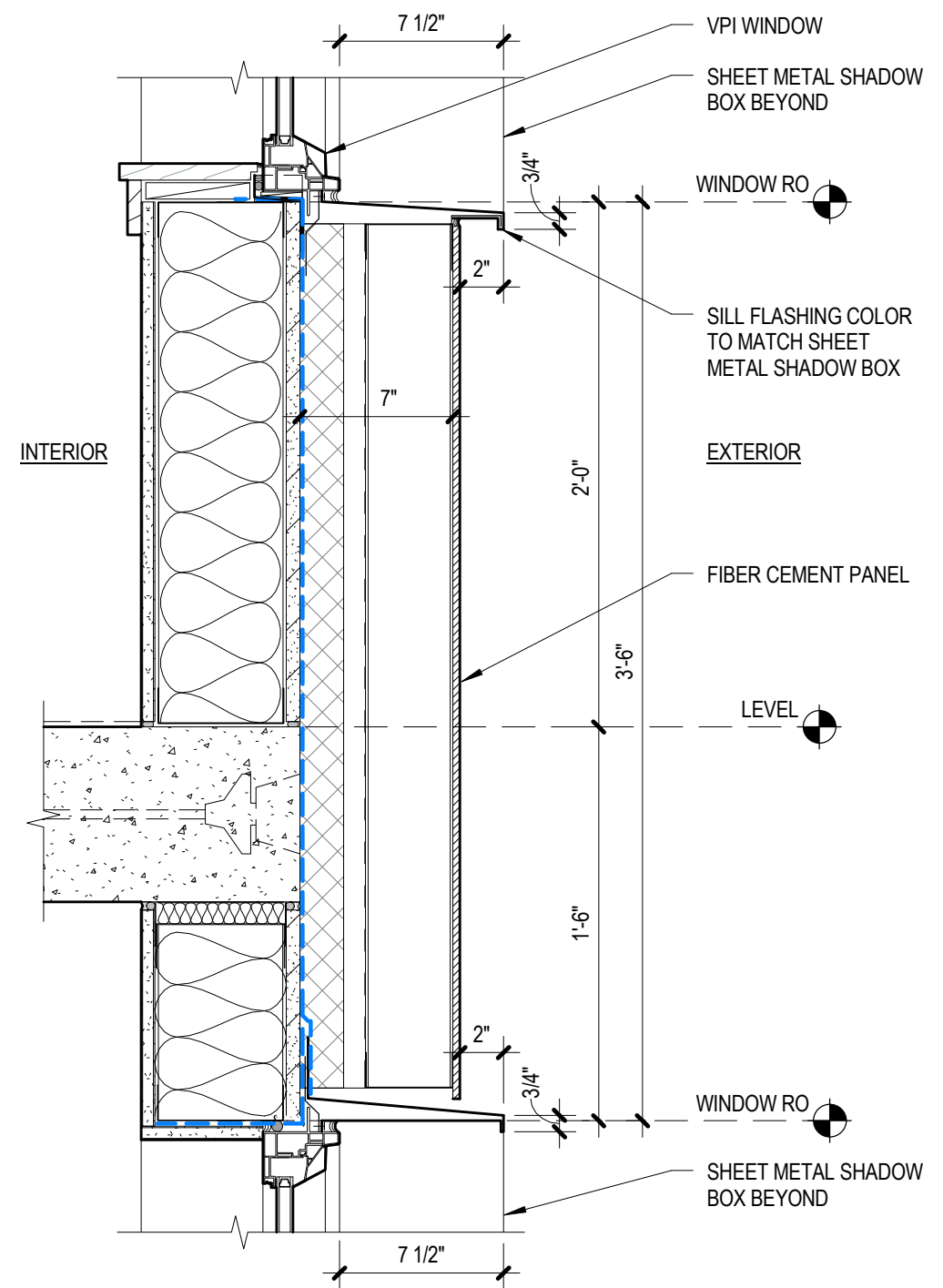

1 WINDOW HEAD/SILL @ DEEP WALL



FIBER CEMENT PANEL (TYPE A & TYPE C)



ALUMINUM STOREFRONT



STRIATED FIBER CEMENT PANEL (TYPE B)

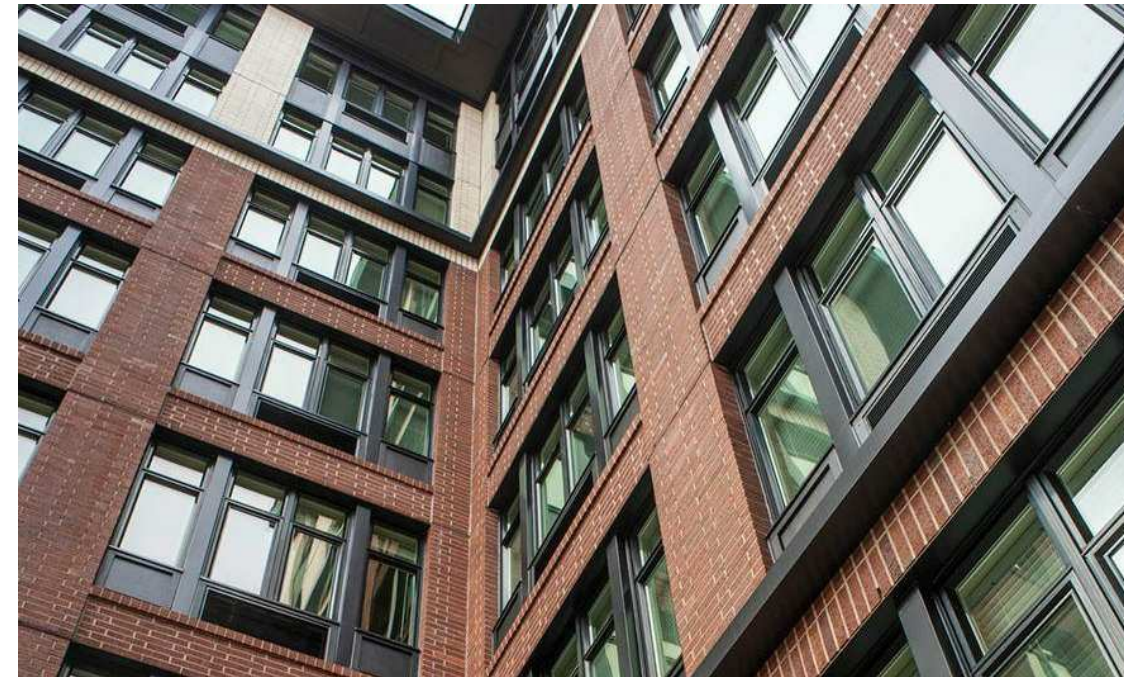

VPI VINYL WINDOWS